

Smart motor driver with embedded Hall sensor

Features

- Motor driver with integrated Hall sensor
- Lock-shutdown protection & auto-restart function
- Precise magnetic switching thresholds
- “Soft-switch” phase-switching technique to reduce vibration and acoustic noise
- Thermal shutdown protection
- Available in SIP-4L packages
- For 12V systems



General Description

FD1157H is a two coil motor driver with embedded Hall sensor. It integrates the motor driver with the Hall sensor, which simplifies the PCB(printed circuit board) design and make the fabrication of small-size motors possible. Lock-shutdown and auto-restart function keeps the motor from being over-heated and restarts the motor after being locked.

“Soft-switch” phase-switching technique is used to reduce the vibration and acoustic noise.

Thermal-shutdown protection ensures the motor driver to operate under specified temperature ranges.

All the protection mechanisms mentioned above combine to provide a complete protecting scenario for the motor system, keep the motor system from possible damages and guarantee correct operations.

Block Diagram

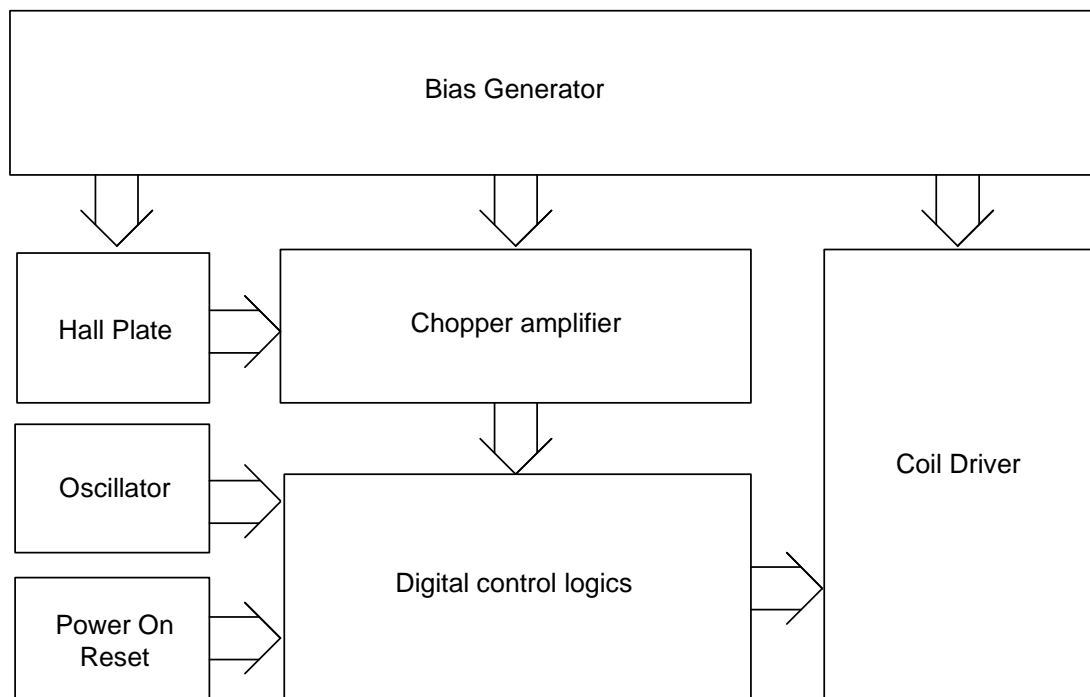
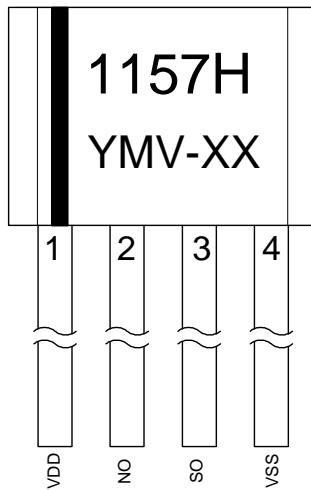
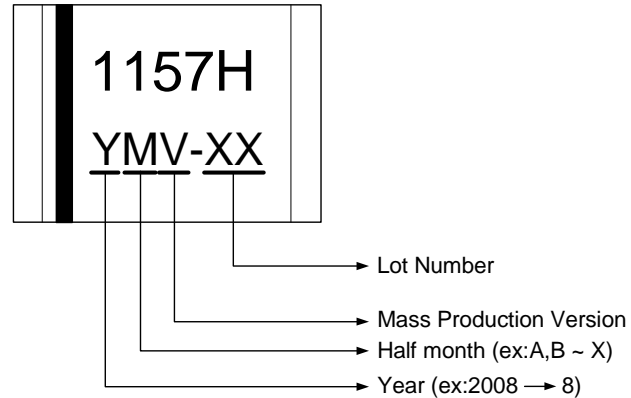

Figure.1

Pin Connection

Figure.2
Marking Distinguish

Figure.3
Pin Descriptions

Name	I/O	FD1157H	Description
VSS	G	4	Ground
SO	O	3	Driver output
NO	O	2	Driver output
VDD	P	1	Positive power supply

Legend: I=input, O=output, I/O=input/output, P=power supply, G=ground

Functional Descriptions

Refer to the block diagram (Figure.1), FD1157H is composed of the following building blocks:

- Bias generator

The bias generator provides precise, temperature- and process-insensitive bias references for the analog circuit blocks. These references guarantee proper operation of the IC under all conditions specified in this specification.

- Oscillator

The built-in oscillator provides the clock signal for the digital control logics

- Power-on Reset

Used to detect the power-up ramp and reset the digital circuits to achieve correct operation as soon as the power is ready.

- Chopper Amplifier

To achieve a higher magnetic sensitivity the chopper amplifier structure is adopted in this design. Use of this structure dynamically removes both the offset and flicker noise at the same time.

- Digital control logics

- Hall sensor part – generates controlling signals for the Hall sensor.
- Coil driver part – generates controlling signals for the Coil driver.

Absolute Maximum Ratings

Parameter	Symbol	Conditions	Values			Unit
			min.	Typ.	max.	
Operating Temperature	T _{OP}	-	-20		105	°C
Storage Temperature	T _{ST}	-	-40		150	°C
Output clamp Voltage	V _C		25		27	V
DC Supply Voltage	V _{DD}	-			18 ⁽¹⁾	V
Supply Current	I _{DD}	-			6	mA
Continuous Current	I _{O(CONT)}				600	mA
Hold Current	I _{O(HOLD)}				900	mA
Peak Current	I _{O(PEAK)}	<100μs			1200	mA
Junction temperature	T _J				180	°C
Power Dissipation	P _D	SIP-4L			1200	mW
Thermal Resistance	θ _{JC}	SIP-4L		62		°C/W
Thermal Resistance	θ _{Ja}	SIP-4L		104		°C/W
Magnetic Flux Density	B				Unlimited	Gauss
IR-Reflow Lead Temperature		10sec			260	°C

Note 1: V_{DD}=18V, If V_{BEMF} is lower than the output clamp voltage (V_C).

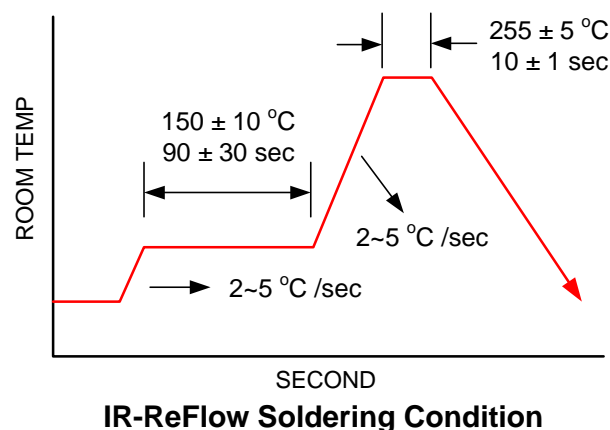
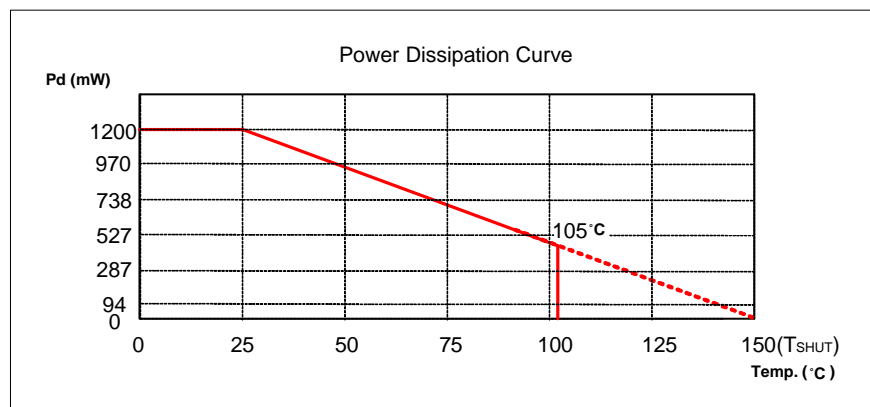

Recommended Operating Conditions

Parameter	Symbol	Conditions	Values			Unit
			min.	typ.	max.	
Supply Voltage	V_{DD}	-	3.0		16 ⁽¹⁾	V
Operating Temperature Range	T_A	-	-20		85	°C

Note 1: $V_{DD}=16V$, If V_{BEMF} is lower than the output clamp voltage (V_c).

Electrical Characteristics $V_{DD}=12.0V$, $T_A=25^\circ C$ (unless otherwise specified)

Parameter	Symbol	Conditions	Values			Unit
			min.	typ.	max.	
Average Supply Current(no load)	I_{DD}			2.5		mA
On resistance (NO, SO pin)	R_{DSON}	$V_{DD}=5V$, $T_A=25^\circ C$, $I_{out}=300mA$		1		Ohm
Thermal Shutdown Threshold	T_{SHUT}		150			°C
Locked Rotor Period	T_{ON}			0.4		s
Locked Rotor Period	T_{OFF}			2.8		s

Magnetic Characteristics

Parameter	Symbol	Conditions	Values			Unit
			min.	typ.	max.	
Operate Points	B_{OP}		5	20	40	G
Release Points	B_{RP}		-5	-20	-40	G

Driver output vs. Magnetic Pole

Parameter	Test Conditions	NO	SO
North pole	$B < B_{rp}$	High	Low
South pole	$B > B_{op}$	Low	High

Note: The magnetic pole is applied facing the branded side of the package

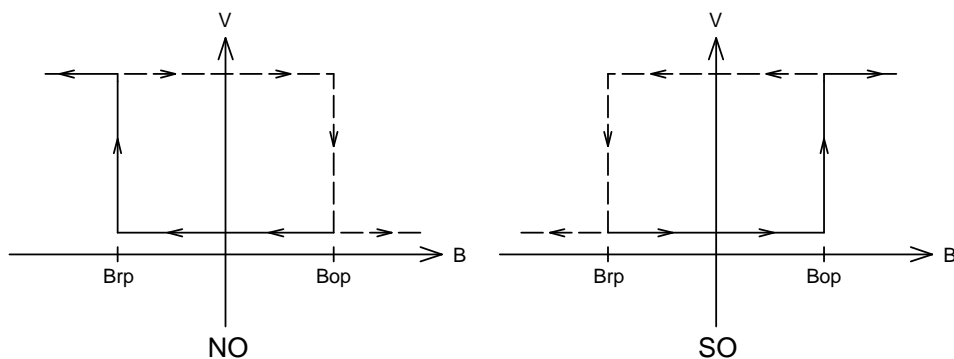
Hysteresis Characteristics

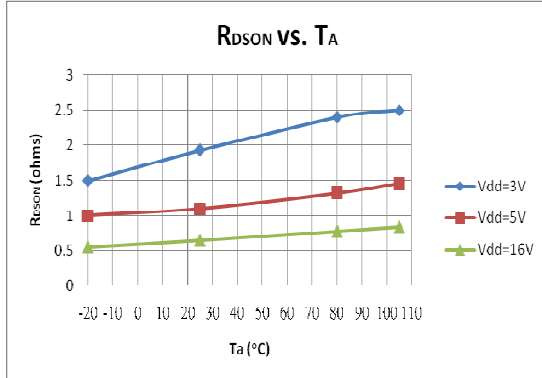
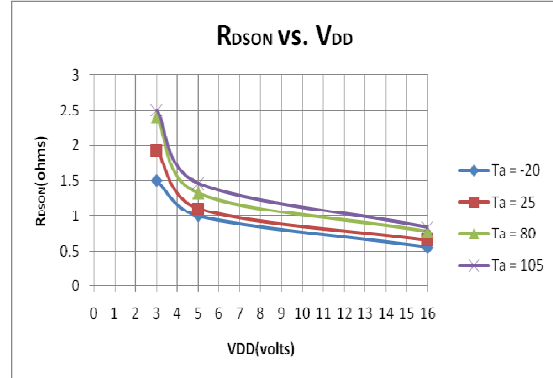
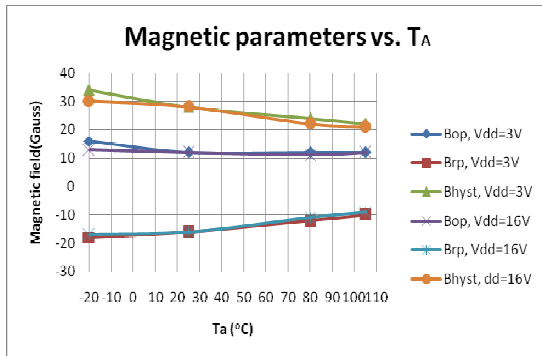
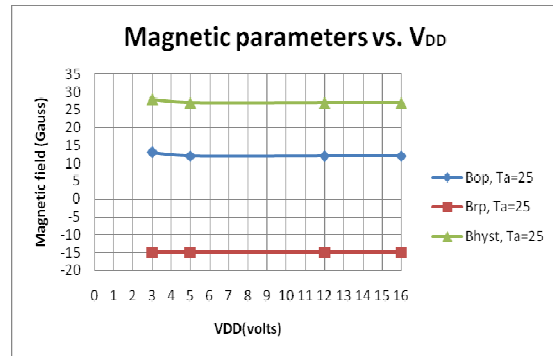
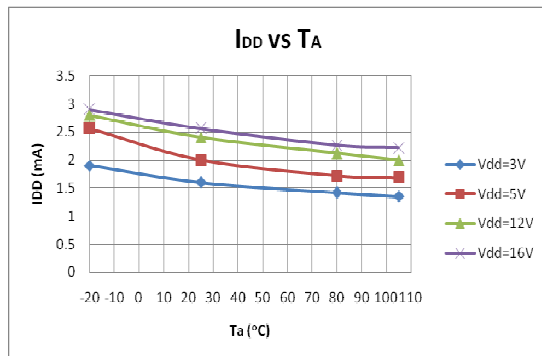
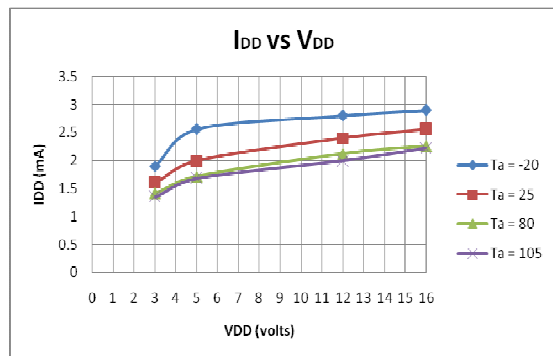
Performance Graphs

Figure.4

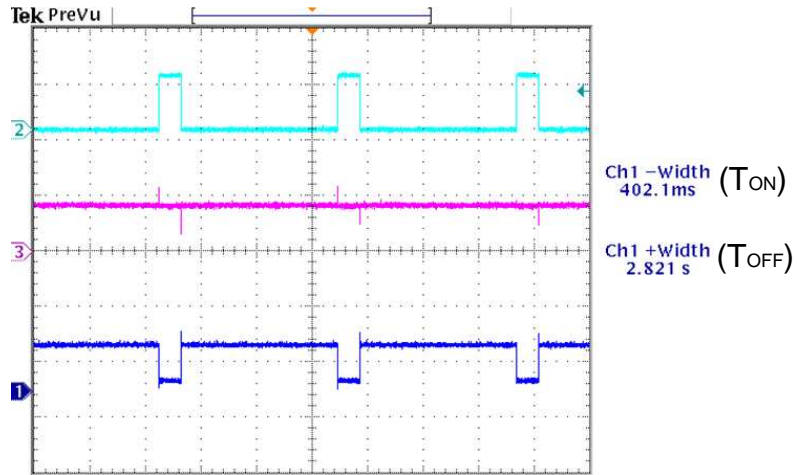
Figure.5

Figure.6

Figure.7

Figure.8

Figure.9

Lock shutdown – Restart Timing Description:



Channel2: V_{DD} pin current waveform

Channel3: Output (SO pin) voltage waveform

Channel1: Output (NO pin) voltage waveform

Note: The North pole (B > Bop) is applied facing the branded side of the package.

Application Circuit Reference

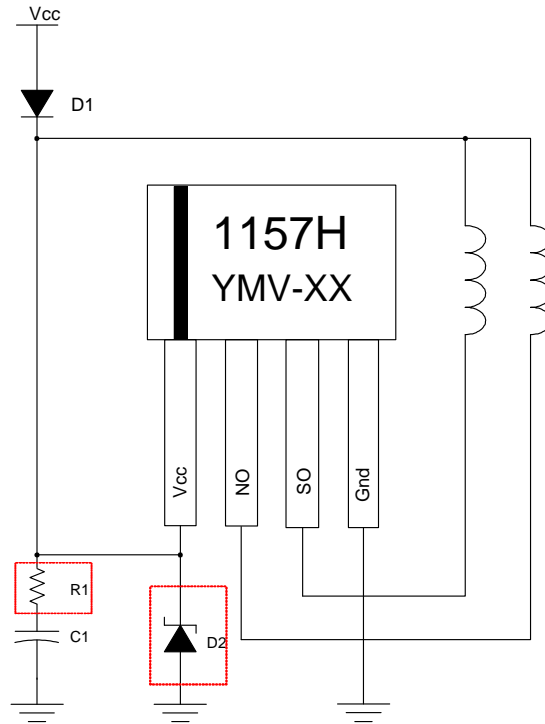
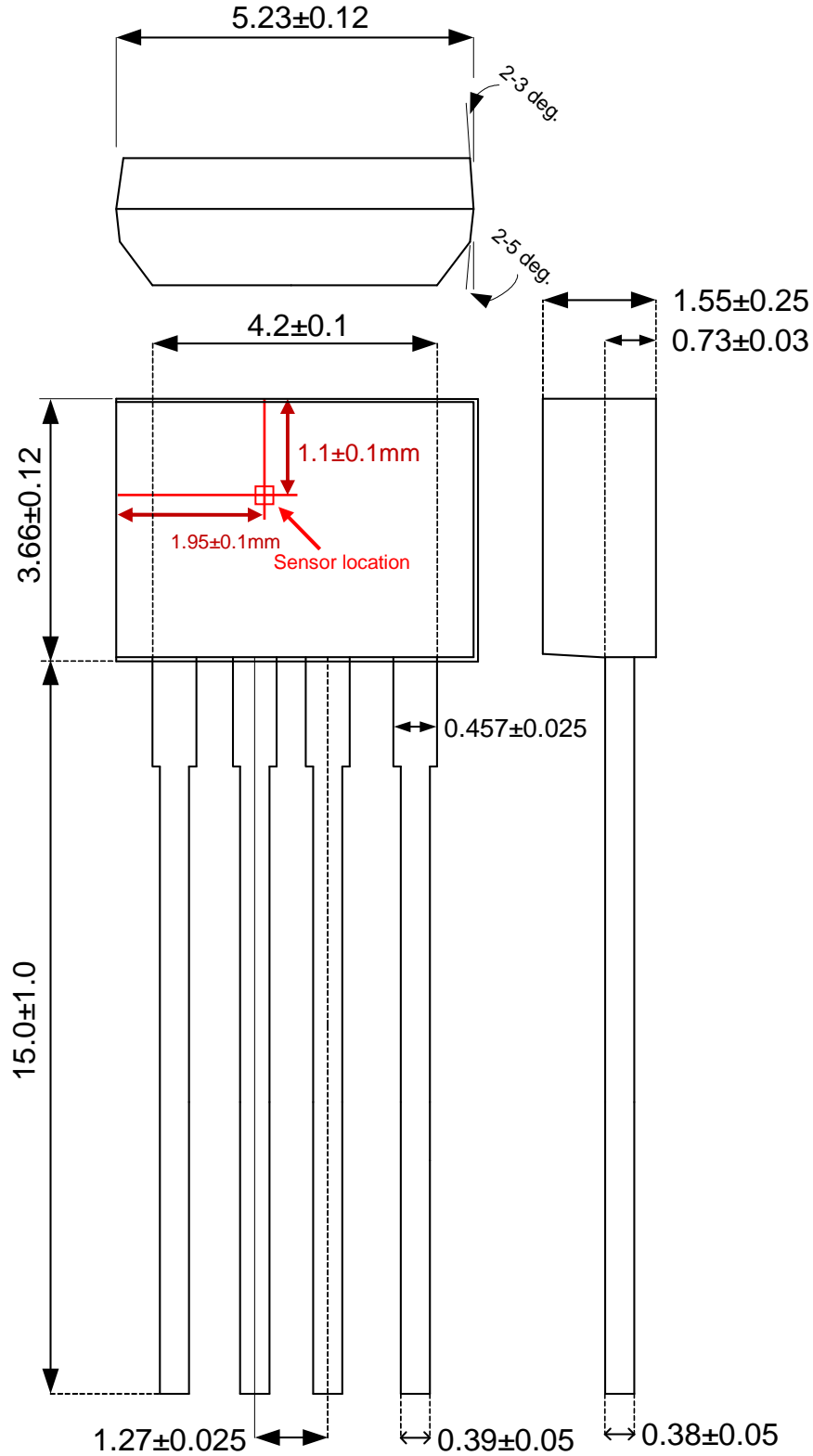

Figure.10

Note: $C1=1\mu F$, $R1=2\sim 5\text{ ohm(option)}$, $D2(option)$ breakdown voltage 16V



Package Dimension (Unit: mm)
SIP-4L(Halogen Free)





Packing Specification

BAG & BOX DIMANSION

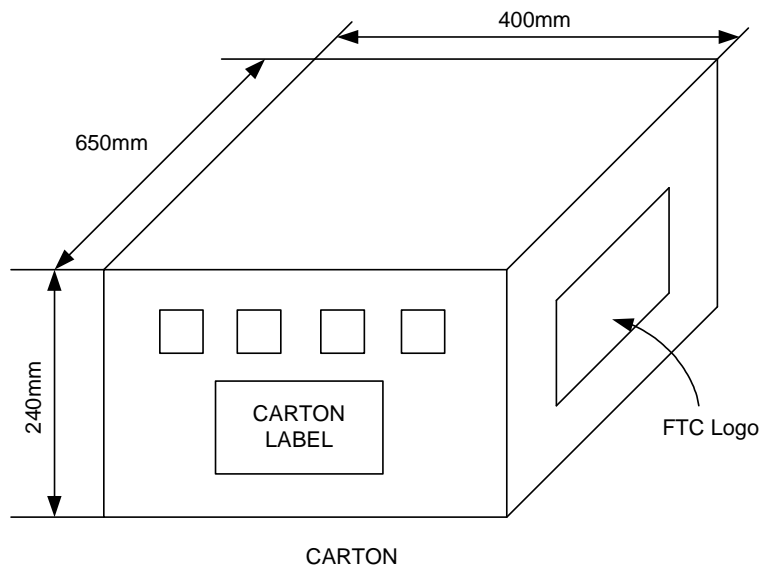
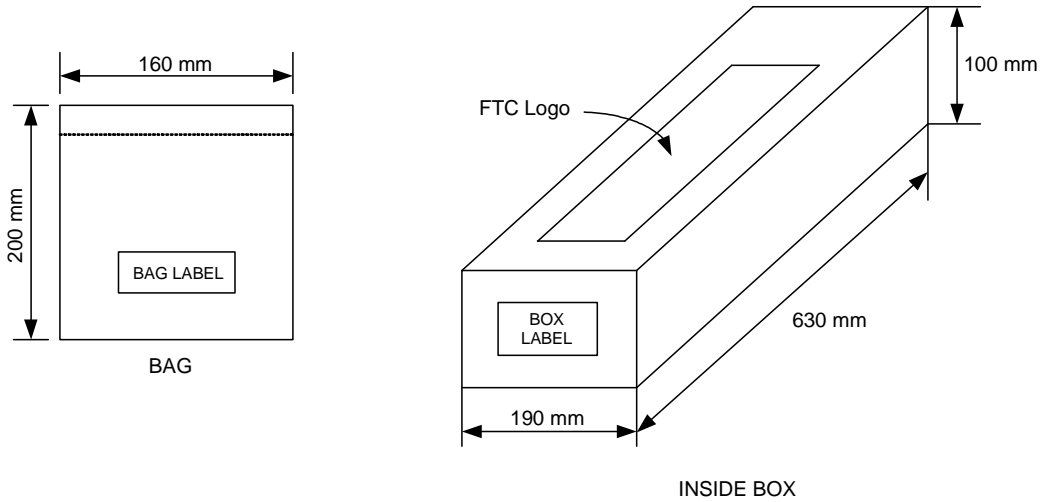

Packing Quantity Specifications

1000 EA / 1 BAG

25 BAGS / 1 INSIDE BOX

4 INSIDE BOXES / 1 CARTON

Order Information

Part Number	Operating Temperature	Package	Description	Marking
FD1157H-G1	-20 °C to +85 °C	SIP-4L	±20G (B)	-