

# FD2000DU-120

HIGH POWER, HIGH FREQUENCY,  
PRESS PACK TYPE

FD2000DU-120



- IF(AV) Average forward current ..... 1700A
- VRRM Repetitive peak reverse voltage ..... 6000V
- QRR Reverse recovery charge ..... 1500μC
- Press pack type

OUTLINE DRAWING

Dimension in mm

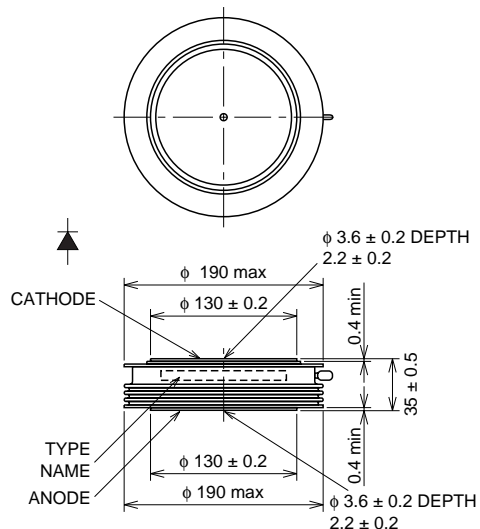

## APPLICATION

High-power inverters, Fly-wheel diodes in DC choppers, Power supplies as high frequency rectifiers

## MAXIMUM RATINGS

Symbol	Parameter	Voltage class		Unit
		120	6000	
VRRM	Repetitive peak reverse voltage	6000		V
VRSM	Non-repetitive peak reverse voltage	6000		V
VR(DC)	DC reverse voltage	4800		V

Symbol	Parameter	Conditions	Ratings	Unit
IF(RMS)	RMS forward current		2670	A
IF(AV)	Average forward current	f = 60Hz, sine wave θ = 180°, Tf = 65°C	1700	A
IFSM	Surge forward current	One half cycle at 60Hz, non-repetitive	40	kA
I <sub>t</sub> <sup>2</sup>	Current-squared, time integration	One cycle at 60Hz	6.7 × 10 <sup>6</sup>	A <sup>2</sup> s
T <sub>j</sub>	Junction temperature		-40 ~ +125	°C
T <sub>stg</sub>	Storage temperature		-40 ~ +150	°C
—	Mounting force required	Recommended value 108	98 ~ 118	kN
—	Weight	Standard value	4600	g

## ELECTRICAL CHARACTERISTICS

Symbol	Parameter	Test conditions	Limits			Unit
			Min	Typ	Max	
IRRM	Repetitive peak reverse current	T <sub>j</sub> = 125°C, VRRM Applied	—	—	300	mA
VFM	Forward voltage	T <sub>j</sub> = 125°C, IFM = 6300A, Instantaneous measurement	—	—	5.0	V
QRR	Reverse recovery charge	IFM = 2000A, diF/dt = -30A/μs, VR = 150V, T <sub>j</sub> = 125°C	—	—	1500	μC
R <sub>th(j-f)</sub>	Thermal resistance	Junction to fin	—	—	0.009	°C/W

# FD2000DU-120

HIGH POWER, HIGH FREQUENCY,  
PRESS PACK TYPE

## PERFORMANCE CURVES

**MAXIMUM FORWARD CHARACTERISTICS**

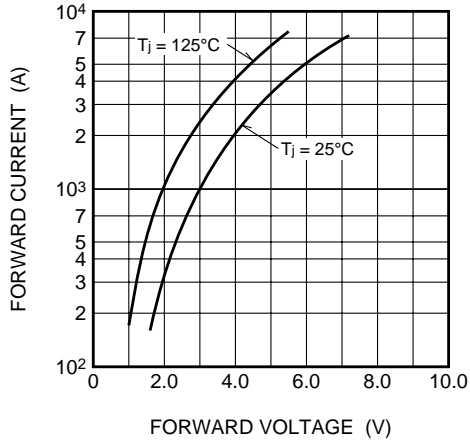

**RATED SURGE FORWARD CURRENT**

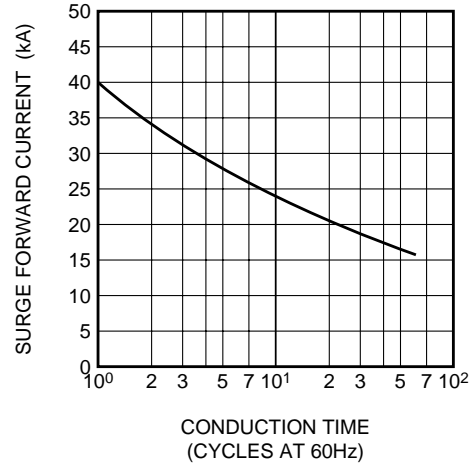

**MAXIMUM THERMAL IMPEDANCE CHARACTERISTIC (JUNCTION TO FIN)**

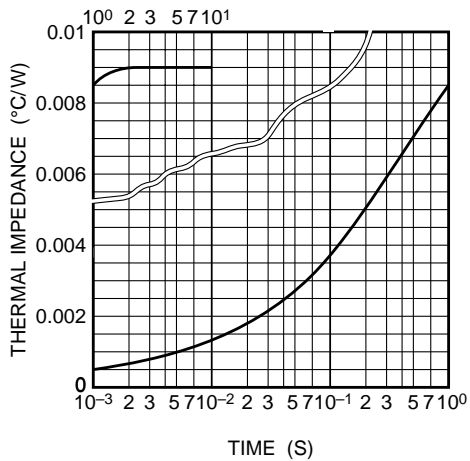

**MAXIMUM POWER DISSIPATION CHARACTERISTICS**

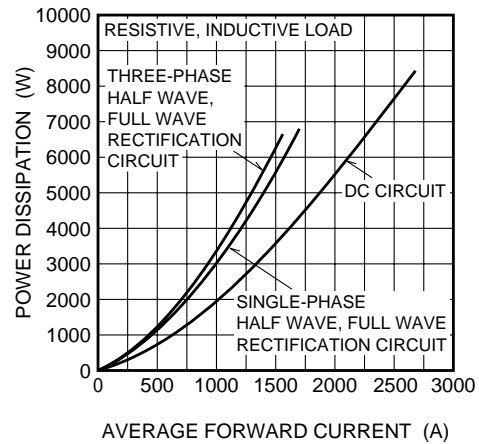

**ALLOWABLE FIN TEMPERATURE VS. AVERAGE FORWARD CURRENT**

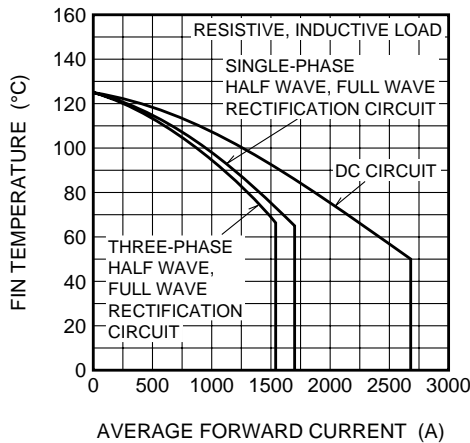

**REVERSE RECOVERY CHARGE, REVERSE RECOVERY TIME VS. JUNCTION TEMPERATURE (TYPICAL)**

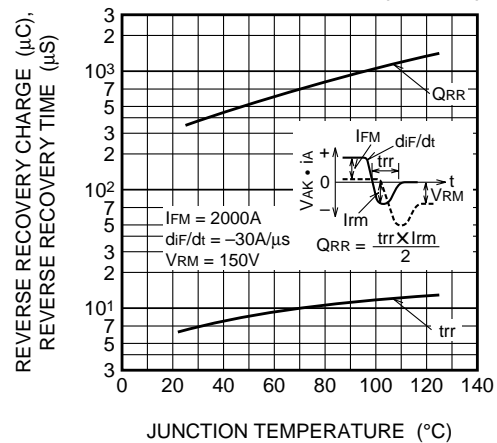

**FD2000DU-120**

HIGH POWER, HIGH FREQUENCY,  
PRESS PACK TYPE

**REVERSE RECOVERY CHARGE,  
REVERSE RECOVERY TIME VS.  
FORWARD CURRENT (TYPICAL)**

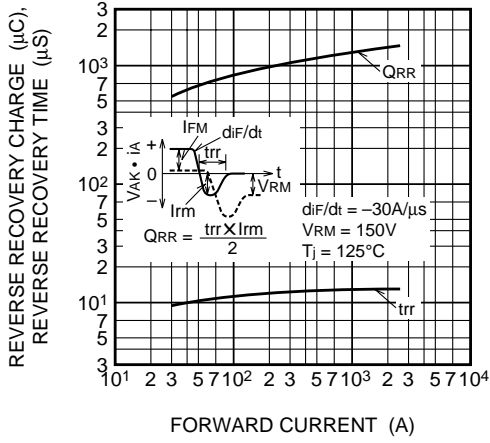

**REVERSE RECOVERY CHARGE,  
REVERSE RECOVERY TIME VS. RATE  
OF DECREASE OF REVERSE CURRENT (TYPICAL)**

