

# FDD3N40 / FDU3N40

## 400V N-Channel MOSFET

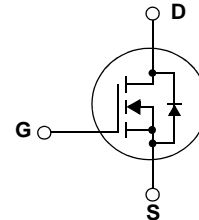
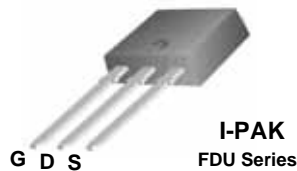
### Features

- 2A, 400V,  $R_{DS(on)} = 3.4\Omega @ V_{GS} = 10V$
- Low gate charge ( typical 4.5 nC)
- Low  $C_{rss}$  ( typical 3.7 pF)
- Fast switching
- 100% avalanche tested
- Improved dv/dt capability

### Description

These N-Channel enhancement mode power field effect transistors are produced using Fairchild's proprietary, planar stripe, DMOS technology.

This advanced technology has been especially tailored to minimize on-state resistance, provide superior switching performance, and withstand high energy pulse in the avalanche and commutation mode. These devices are well suited for high efficient switched mode power supplies and active power factor correction.



### Absolute Maximum Ratings

Symbol	Parameter	FDD3N40 / FDU3N40	Unit
$V_{DSS}$	Drain-Source Voltage	400	V
$I_D$	Drain Current - Continuous ( $T_C = 25^\circ\text{C}$ ) - Continuous ( $T_C = 100^\circ\text{C}$ )	2.0 1.25	A A
$I_{DM}$	Drain Current - Pulsed (Note 1)	8.0	A
$V_{GSS}$	Gate-Source voltage	$\pm 30$	V
$E_{AS}$	Single Pulsed Avalanche Energy (Note 2)	46	mJ
$I_{AR}$	Avalanche Current (Note 1)	2	A
$E_{AR}$	Repetitive Avalanche Energy (Note 1)	3	mJ
dv/dt	Peak Diode Recovery dv/dt (Note 3)	4.5	V/ns
$P_D$	Power Dissipation ( $T_C = 25^\circ\text{C}$ ) - Derate above $25^\circ\text{C}$	30 0.24	W W/ $^\circ\text{C}$
$T_J, T_{STG}$	Operating and Storage Temperature Range	-55 to +150	$^\circ\text{C}$
$T_L$	Maximum Lead Temperature for Soldering Purpose, 1/8" from Case for 5 Seconds	300	$^\circ\text{C}$

\* Drain current limited by maximum junction temperature

### Thermal Characteristics

Symbol	Parameter	Typ	Max	Unit
$R_{\theta JC}$	Thermal Resistance, Junction-to-Case	--	4.2	$^\circ\text{C}/\text{W}$
$R_{\theta JA}$	Thermal Resistance, Case-to-Sink Typ.	--	110	$^\circ\text{C}/\text{W}$

## Package Marking and Ordering Information

Device Marking	Device	Package	Reel Size	Tape Width	Quantity
FDD3N40	FDD3N40TM	D-PAK	380mm	16mm	2500
FDD3N40	FDD3N40TF	D-PAK	380mm	16mm	2000
FDU3N40	FDU3N40TU	I-PAK	-	-	70

## Electrical Characteristics T<sub>C</sub> = 25°C unless otherwise noted

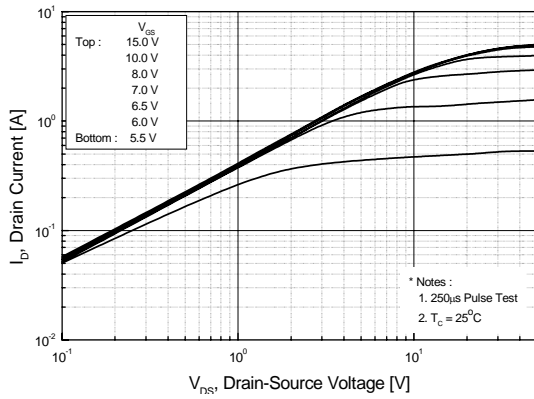
Symbol	Parameter	Conditions	Min.	Typ.	Max	Units
<b>Off Characteristics</b>						
BV <sub>DSS</sub>	Drain-Source Breakdown Voltage	V <sub>GS</sub> = 0V, I <sub>D</sub> = 250μA	400	--	--	V
ΔBV <sub>DSS</sub> / ΔT <sub>J</sub>	Breakdown Voltage Temperature Coefficient	I <sub>D</sub> = 250μA, Referenced to 25°C	--	0.4	--	V/°C
I <sub>DSS</sub>	Zero Gate Voltage Drain Current	V <sub>DS</sub> = 400V, V <sub>GS</sub> = 0V V <sub>DS</sub> = 320V, T <sub>C</sub> = 125°C	--	--	1 10	μA μA
I <sub>GSSF</sub>	Gate-Body Leakage Current, Forward	V <sub>GS</sub> = 30V, V <sub>DS</sub> = 0V	--	--	100	nA
I <sub>GSSR</sub>	Gate-Body Leakage Current, Reverse	V <sub>GS</sub> = -30V, V <sub>DS</sub> = 0V	--	--	-100	nA
<b>On Characteristics</b>						
V <sub>GS(th)</sub>	Gate Threshold Voltage	V <sub>DS</sub> = V <sub>GS</sub> , I <sub>D</sub> = 250μA	3.0	--	5.0	V
R <sub>DS(on)</sub>	Static Drain-Source On-Resistance	V <sub>GS</sub> = 10V, I <sub>D</sub> = 1A	--	2.8	3.4	Ω
g <sub>FS</sub>	Forward Transconductance	V <sub>DS</sub> = 40V, I <sub>D</sub> = 1A (Note 4)	--	2	--	S
<b>Dynamic Characteristics</b>						
C <sub>iss</sub>	Input Capacitance	V <sub>DS</sub> = 25V, V <sub>GS</sub> = 0V, f = 1.0MHz	--	173	225	pF
C <sub>oss</sub>	Output Capacitance		--	30	40	pF
C <sub>rss</sub>	Reverse Transfer Capacitance		--	3.7	6	pF
<b>Switching Characteristics</b>						
t <sub>d(on)</sub>	Turn-On Delay Time	V <sub>DD</sub> = 200V, I <sub>D</sub> = 3A R <sub>G</sub> = 25Ω  (Note 4, 5)	--	10	30	ns
t <sub>r</sub>	Turn-On Rise Time		--	30	70	ns
t <sub>d(off)</sub>	Turn-Off Delay Time		--	10	30	ns
t <sub>f</sub>	Turn-Off Fall Time		--	25	60	ns
Q <sub>g</sub>	Total Gate Charge	V <sub>DS</sub> = 320V, I <sub>D</sub> = 3A V <sub>GS</sub> = 10V  (Note 4, 5)	--	4.5	6	nC
Q <sub>gs</sub>	Gate-Source Charge		--	1.2	--	nC
Q <sub>gd</sub>	Gate-Drain Charge		--	2	--	nC
<b>Drain-Source Diode Characteristics and Maximum Ratings</b>						
I <sub>S</sub>	Maximum Continuous Drain-Source Diode Forward Current		--	--	2	A
I <sub>SM</sub>	Maximum Pulsed Drain-Source Diode Forward Current		--	--	8	A
V <sub>SD</sub>	Drain-Source Diode Forward Voltage	V <sub>GS</sub> = 0V, I <sub>S</sub> = 2A	--	--	1.4	V
t <sub>rr</sub>	Reverse Recovery Time	V <sub>GS</sub> = 0V, I <sub>S</sub> = 3A di <sub>F</sub> /dt = 100A/μs  (Note 4)	--	210	--	ns
Q <sub>rr</sub>	Reverse Recovery Charge		--	0.75	--	μC

### NOTES:

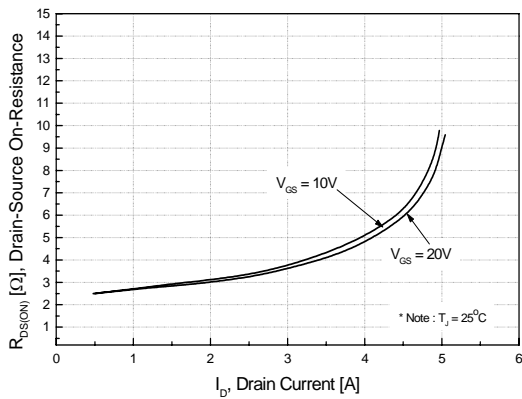
1. Repetitive Rating: Pulse width limited by maximum junction temperature
2. L = 20mH, I<sub>AS</sub> = 2A, V<sub>DD</sub> = 50V, R<sub>G</sub> = 25Ω, Starting T<sub>J</sub> = 25°C
3. I<sub>SD</sub> ≤ 2A, di/dt ≤ 200A/μs, V<sub>DD</sub> ≤ BV<sub>DSS</sub>, Starting T<sub>J</sub> = 25°C
4. Pulse Test: Pulse width ≤ 300μs, Duty Cycle ≤ 2%
5. Essentially Independent of Operating Temperature Typical Characteristics

## Typical Performance Characteristics

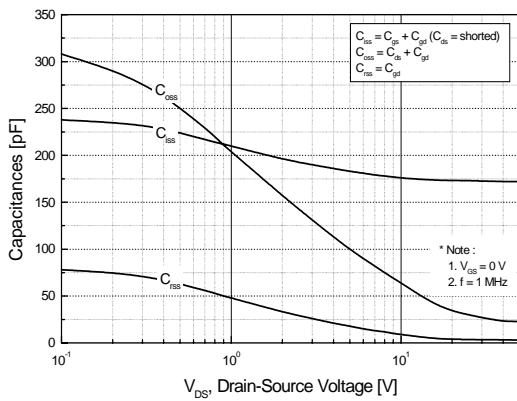
**Figure 1. On-Region Characteristics**



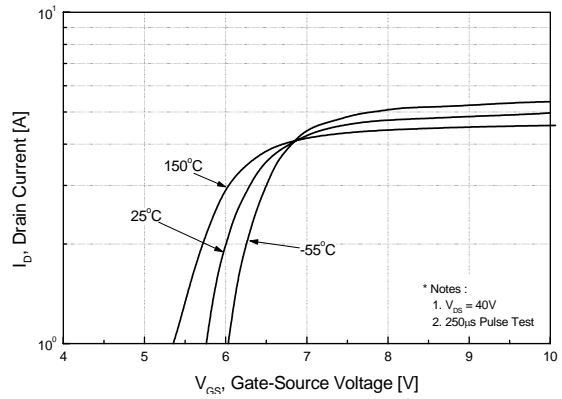
**Figure 3. On-Resistance Variation vs. Drain Current and Gate Voltage**



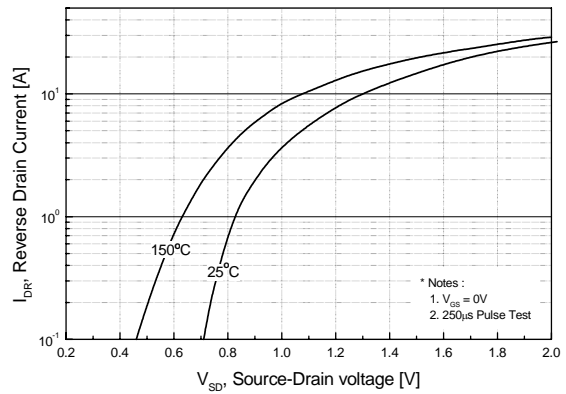
**Figure 5. Capacitance Characteristics**



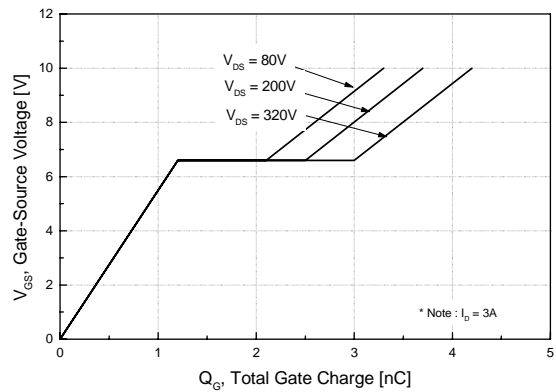
**Figure 2. Transfer Characteristics**



**Figure 4. Body Diode Forward Voltage Variation vs. Source Current and Temperature**

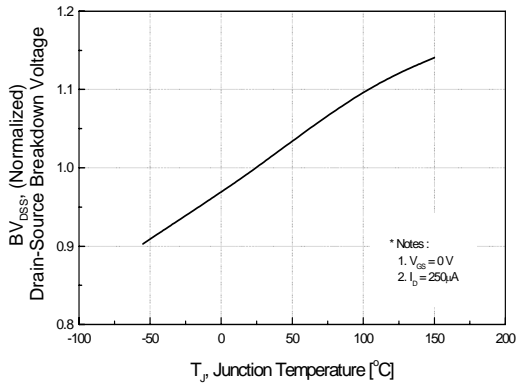


**Figure 6. Gate Charge Characteristics**

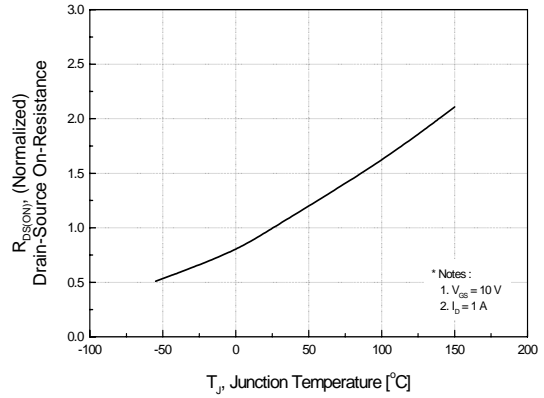


**Typical Performance Characteristics** (Continued)

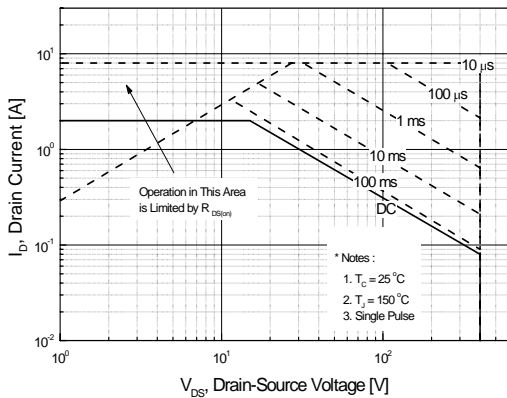
**Figure 7. Breakdown Voltage Variation vs. Temperature**



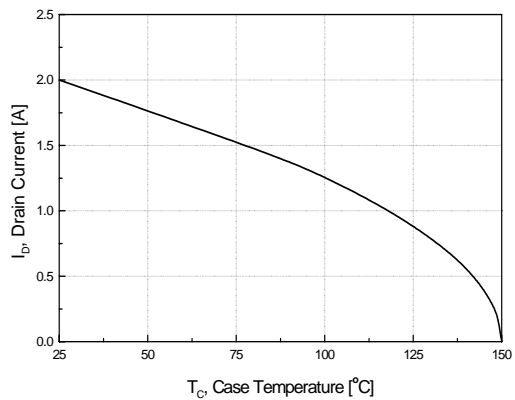
**Figure 8. On-Resistance Variation vs. Temperature**



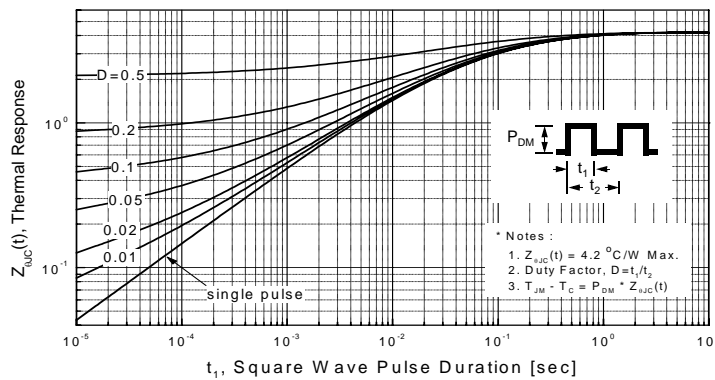
**Figure 9. Maximum Safe Operating Area**



**Figure 10. Maximum Drain Current vs. Case Temperature**



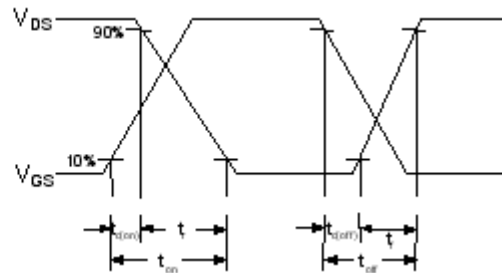
**Figure 11. Transient Thermal Response Curve**



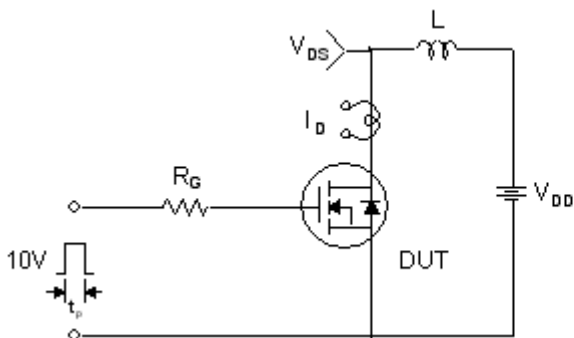
**Gate Charge Test Circuit & Waveform**



**Resistive Switching Test Circuit & Waveforms**



**Unclamped Inductive Switching Test Circuit & Waveforms**

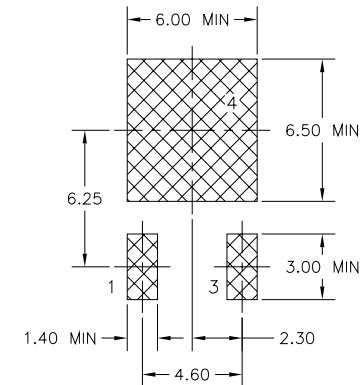
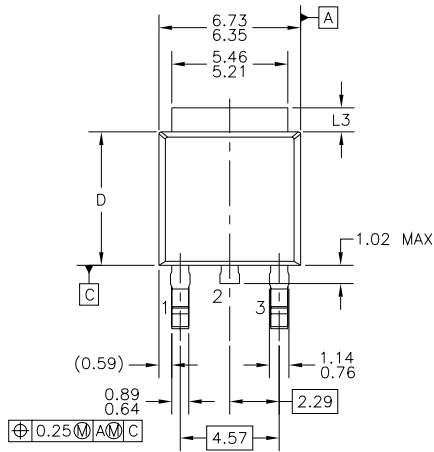


**Peak Diode Recovery dv/dt Test Circuit & Waveforms**

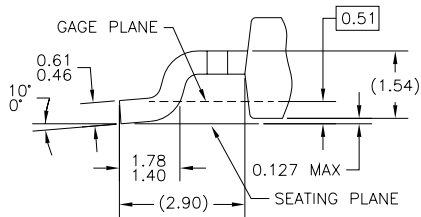
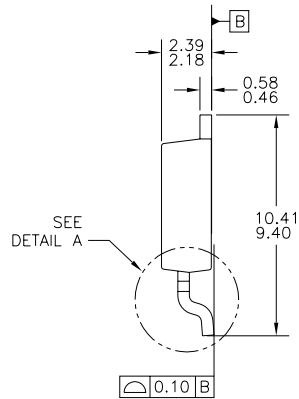
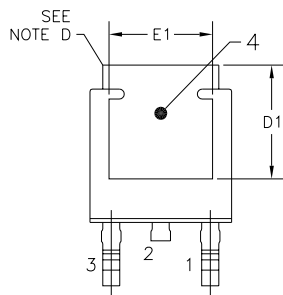


**Mechanical Dimensions**

**D-PAK**



LAND PATTERN RECOMMENDATION

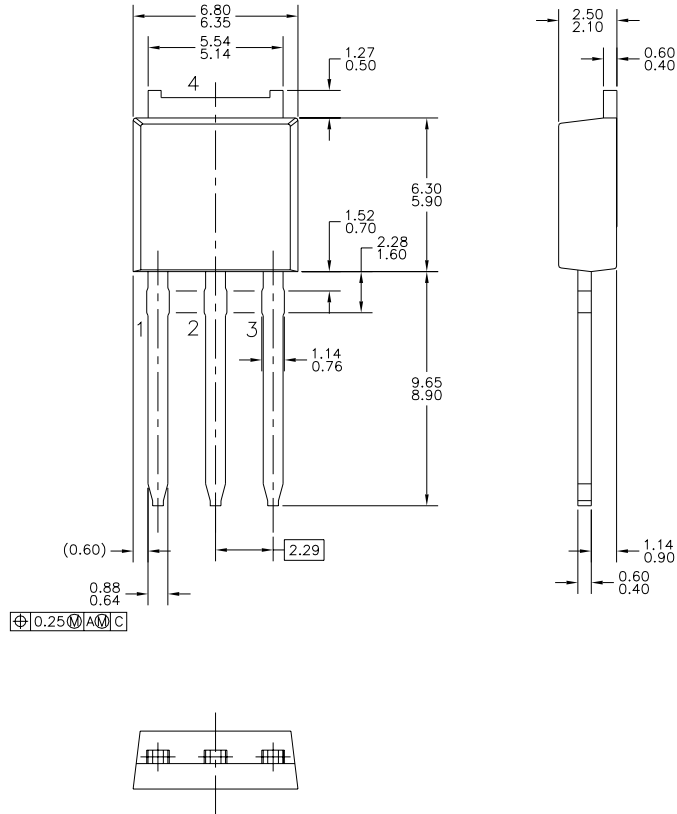


**DETAIL A**  
(ROTATED -90°)  
SCALE: 12X

- NOTES: UNLESS OTHERWISE SPECIFIED
- A) ALL DIMENSIONS ARE IN MILLIMETERS.
  - B) THIS PACKAGE CONFORMS TO JEDEC, TO-252, ISSUE C, VARIATION AA & AB, DATED NOV. 1999.
  - C) DIMENSIONING AND TOLERANCING PER ASME Y14.5M-1994.
  - D) HEAT SINK TOP EDGE COULD BE IN CHAMFERED CORNERS OR EDGE PROTRUSION.
  - E) DIMENSIONS L3,D,E1&D1 TABLE:
- |    | OPTION AA | OPTION AB |
|----|-----------|-----------|
| L3 | 0.89-1.27 | 1.52-2.03 |
| D  | 5.97-6.22 | 5.33-5.59 |
| E1 | 4.32 MIN  | 3.81 MIN  |
| D1 | 5.21 MIN  | 4.57 MIN  |
- F) PRESENCE OF TRIMMED CENTER LEAD IS OPTIONAL.

Mechanical Dimensions

I-PAK








## TRADEMARKS

The following are registered and unregistered trademarks Fairchild Semiconductor owns or is authorized to use and is not intended to be an exhaustive list of all such trademarks.

ACEx <sup>®</sup>	HiSeC <sup>™</sup>	PowerTrench <sup>®</sup>	TinyLogic <sup>®</sup>
Across the board. Around the world. <sup>™</sup>	<i>i-Lo</i> <sup>™</sup>	Programmable Active Droop <sup>™</sup>	TINYOPTO <sup>™</sup>
ActiveArray <sup>™</sup>	ImpliedDisconnect <sup>™</sup>	QFET <sup>®</sup>	TinyPower <sup>™</sup>
Bottomless <sup>™</sup>	IntelliMAX <sup>™</sup>	QS <sup>™</sup>	TinyWire <sup>™</sup>
Build it Now <sup>™</sup>	ISOPLANAR <sup>™</sup>	QT Optoelectronics <sup>™</sup>	TruTranslation <sup>™</sup>
CoolFET <sup>™</sup>	MICROCOUPLER <sup>™</sup>	Quiet Series <sup>™</sup>	μSerDes <sup>™</sup>
CROSSVOLT <sup>™</sup>	MicroPak <sup>™</sup>	RapidConfigure <sup>™</sup>	UHC <sup>®</sup>
CTL <sup>™</sup>	MICROWIRE <sup>™</sup>	RapidConnect <sup>™</sup>	UniFET <sup>™</sup>
Current Transfer Logic <sup>™</sup>	MSX <sup>™</sup>	ScalarPump <sup>™</sup>	VCX <sup>™</sup>
DOME <sup>™</sup>	MSXPro <sup>™</sup>	SMART START <sup>™</sup>	Wire <sup>™</sup>
E <sup>2</sup> CMOS <sup>™</sup>	OCX <sup>™</sup>	SPM <sup>®</sup>	
EcoSPARK <sup>®</sup>	OCXPro <sup>™</sup>	SuperFET <sup>™</sup>	
EnSigna <sup>™</sup>	OPTOLOGIC <sup>®</sup>	SuperSOT <sup>™</sup> -3	
FACT Quiet Series <sup>™</sup>	OPTOPLANAR <sup>®</sup>	SuperSOT <sup>™</sup> -6	
FACT <sup>®</sup>	PACMAN <sup>™</sup>	SuperSOT <sup>™</sup> -8	
FAST <sup>®</sup>	POP <sup>™</sup>	TCM <sup>™</sup>	
FASTr <sup>™</sup>	Power220 <sup>®</sup>	The Power Franchise <sup>®</sup>	
FPS <sup>™</sup>	Power247 <sup>®</sup>	 ™	
FRFET <sup>®</sup>	PowerEdge <sup>™</sup>	TinyBoost <sup>™</sup>	
GlobalOptoisolator <sup>™</sup>	PowerSaver <sup>™</sup>	TinyBuck <sup>™</sup>	
GTO <sup>™</sup>			

## DISCLAIMER

FAIRCHILD SEMICONDUCTOR RESERVES THE RIGHT TO MAKE CHANGES WITHOUT FURTHER NOTICE TO ANY PRODUCTS HEREIN TO IMPROVE RELIABILITY, FUNCTION OR DESIGN. FAIRCHILD DOES NOT ASSUME ANY LIABILITY ARISING OUT OF THE APPLICATION OR USE OF ANY PRODUCT OR CIRCUIT DESCRIBED HEREIN; NEITHER DOES IT CONVEY ANY LICENSE UNDER ITS PATENT RIGHTS, NOR THE RIGHTS OF OTHERS. THESE SPECIFICATIONS DO NOT EXPAND THE TERMS OF FAIRCHILD'S WORLDWIDE TERMS AND CONDITIONS, SPECIFICALLY THE WARRANTY THEREIN, WHICH COVERS THESE PRODUCTS.

## LIFE SUPPORT POLICY

FAIRCHILD'S PRODUCTS ARE NOT AUTHORIZED FOR USE AS CRITICAL COMPONENTS IN LIFE SUPPORT DEVICES OR SYSTEMS WITHOUT THE EXPRESS WRITTEN APPROVAL OF FAIRCHILD SEMICONDUCTOR CORPORATION.

As used herein:

1. Life support devices or systems are devices or systems which, (a) are intended for surgical implant into the body or (b) support or sustain life, and (c) whose failure to perform when properly used in accordance with instructions for use provided in the labeling, can be reasonably expected to result in a significant injury of the user.
2. A critical component in any component of a life support, device, or system whose failure to perform can be reasonably expected to cause the failure of the life support device or system, or to affect its safety or effectiveness.

## PRODUCT STATUS DEFINITIONS

### Definition of Terms

Datasheet Identification	Product Status	Definition
Advance Information	Formative or In Design	This datasheet contains the design specifications for product development. Specifications may change in any manner without notice.
Preliminary	First Production	This datasheet contains preliminary data; supplementary data will be published at a later date. Fairchild Semiconductor reserves the right to make changes at any time without notice to improve design.
No Identification Needed	Full Production	This datasheet contains final specifications. Fairchild Semiconductor reserves the right to make changes at any time without notice to improve design.
Obsolete	Not In Production	This datasheet contains specifications on a product that has been discontinued by Fairchild Semiconductor. The datasheet is printed for reference information only.

Rev. I23