



APPLICATIONS

Wireless Network
Telecom/Datacom
Industry Control System
Measurement Equipment
Semiconductor Equipment

FEATURES

- 15 WATTS OUTPUT POWER
- OUTPUT CURRENT UP TO 4A
- STANDARD 2.0 X 1.0 X 0.4 INCH PACKAGE
- HIGH EFFICIENCY UP TO 88%
- 2:1 WIDE INPUT VOLTAGE RANGE
- SIX-SIDED CONTINUOUS SHIELD
- FIXED SWITCHING FREQUENCY
- CE MARK MEETS 2006/95/EC,93/68/EEC AND 2004/108/EC
- UL60950-1, EN60950-1 AND IEC60950-1 LICENSED
- ISO9001 CERTIFIED MANUFACTURING FACILITIES
- COMPLIANT TO RoHS EU DIRECTIVE 2002/95/EC

OPTIONS

Positive logic & Negative logic Remote On/Off

DESCRIPTION

The FEC15 series offer 15 watts of output power from a 2 x 1 x 0.4 inch package. The FEC15 series with 2:1 wide input voltage of 9-18, 18-36 and 36-75VDC.

TECHNICAL SPECIFICATION All specifications are typical at nominal input, full load and 25°C otherwise noted

OUTPUT SPECIFICATIONS			
Output power			15 Watts, max.
Voltage accuracy	Full load and nominal Vin		± 1%
Minimum load (Note 6)			See Table
Line regulation	LL to HL at Full Load		± 0.5%
Load regulation	Min. load to Full load	Single Dual	± 0.5% ± 1%
Cross regulation (Dual)	Asymmetrical load 25% / 100% FL		± 5%
Ripple and noise	20MHz bandwidth	Single Dual	50mVp-p 75mVp-p
Temperature coefficient			±0.02% / °C, max.
Transient response recovery time	25% load step change		250µS
Over voltage protection (Zener diode clamp)	3.3V output		3.9VDC
	5V output		6.2VDC
	12V output		15VDC
	15V output		18VDC
Over load protection	% of FL at nominal input		150%, max.
Short circuit protection			Hiccup, automatics recovery
GENERAL SPECIFICATIONS			
Efficiency			See table
Isolation voltage			1600VDC, min.
Isolation resistance			10 ⁹ ohms, min.
Isolation capacitance			300pF, max.
Switching frequency	Single output Dual output		500KHz, typ. 300KHz, typ.
Approvals and standard			IEC60950-1, UL60950-1, EN60950-1
Case material			Nickel-coated copper
Base material			Non-conductive black plastic
Potting material			Epoxy (UL94-V0)
Dimensions			2.00 X 1.00 X 0.40 Inch (50.8 X 25.4 X 10.2 mm)
Weight			27g (0.95oz)
MTBF (Note 1)	BELLCORE TR-NWT-000332		2.041 x 10 ⁶ hrs
	MIL-HDBK-217F		1.044 x 10 ⁶ hrs

INPUT SPECIFICATIONS			
Input voltage range	12V nominal input		9 – 18VDC
	24V nominal input		18 – 36VDC
	48V nominal input		36 – 75VDC
Input filter			Pi type
Input surge voltage 100mS max	12V input		36VDC
	24V input		50VDC
	48V input		100VDC
Input reflected ripple current	Nominal Vin and full load		20mAp-p
Start up time	Nominal Vin and constant resistive load	Power up	20mS, typ.
Remote ON/OFF (Option) (Note 7)			
(Positive logic)	DC-DC ON		Open or 3.5V < Vr < 12V
	DC-DC OFF		Short or 0V < Vr < 1.2V
(Negative logic)	DC-DC ON		Short or 0V < Vr < 1.2V
	DC-DC OFF		Open or 3.5V < Vr < 12V
Input current of remote control pin	Nominal Vin		-0.5mA ~ +1mA
Remote off state input current	Nominal Vin		20mA

ENVIRONMENTAL SPECIFICATIONS			
Operating ambient temperature			-40°C ~ +85°C (with derating)
Maximum case temperature			100°C
Storage temperature range			-55°C ~ +105°C
Thermal impedance (Note 8)	Nature convection		12°C/Watt
	Nature convection with heat-sink		10°C/Watt
Thermal shock			MIL-STD-810F
Vibration			MIL-STD-810F
Relative humidity			5% to 95% RH

EMC CHARACTERISTICS			
EMI (Note 9)	EN55022		Class A
ESD	EN61000-4-2	Air	± 8KV
		Contact	± 6KV
Radiated immunity	EN61000-4-3	10 V/m	Perf. Criteria A
Fast transient (Note 10)	EN61000-4-4	± 2KV	Perf. Criteria B
Surge (Note 10)	EN61000-4-5	± 1KV	Perf. Criteria B
Conducted immunity	EN61000-4-6	10 Vr.m.s	Perf. Criteria A





Model Number	Input Range	Output Voltage	Output Current		Output (4) Ripple & Noise	Input Current		Eff (4) (%)	Capacitor (5) Load max
			Min. load	Full load		No load (3)	Full load (2)		
FEC15-12S33	9 – 18 VDC	3.3 VDC	0mA	4000mA	50mVp-p	30mA	1467mA	79	10200µF
FEC15-12S05	9 – 18 VDC	5 VDC	15mA	3000mA	50mVp-p	25mA	1603mA	82	7050µF
FEC15-12S12	9 – 18 VDC	12 VDC	0mA	1250mA	50mVp-p	25mA	1524mA	86	1035µF
FEC15-12S15	9 – 18 VDC	15 VDC	0mA	1000mA	50mVp-p	20mA	1524mA	86	705µF
FEC15-12D05	9 – 18 VDC	± 5 VDC	0mA	± 1500mA	75mVp-p	20mA	1582mA	83	± 1020µF
FEC15-12D12	9 – 18 VDC	± 12 VDC	0mA	± 625mA	75mVp-p	30mA	1524mA	86	± 495µF
FEC15-12D15	9 – 18 VDC	± 15 VDC	±10mA	± 500mA	75mVp-p	35mA	1563mA	84	± 165µF
FEC15-24S33	18 – 36 VDC	3.3 VDC	0mA	4000mA	50mVp-p	15mA	724mA	80	10200µF
FEC15-24S05	18 – 36 VDC	5 VDC	15mA	3000mA	50mVp-p	10mA	781mA	84	7050µF
FEC15-24S12	18 – 36 VDC	12 VDC	0mA	1250mA	50mVp-p	20mA	772mA	85	1035µF
FEC15-24S15	18 – 36 VDC	15 VDC	10mA	1000mA	50mVp-p	15mA	772mA	85	705µF
FEC15-24D05	18 – 36 VDC	± 5 VDC	0mA	± 1500mA	75mVp-p	15mA	781mA	84	± 1020µF
FEC15-24D12	18 – 36 VDC	± 12 VDC	0mA	± 625mA	75mVp-p	25mA	762mA	86	± 495µF
FEC15-24D15	18 – 36 VDC	± 15 VDC	0mA	± 500mA	75mVp-p	25mA	762mA	86	± 165µF
FEC15-48S33	36 – 75 VDC	3.3 VDC	0mA	4000mA	50mVp-p	10mA	357mA	81	10200µF
FEC15-48S05	36 – 75 VDC	5 VDC	0mA	3000mA	50mVp-p	20mA	396mA	83	7050µF
FEC15-48S12	36 – 75 VDC	12 VDC	10mA	1250mA	50mVp-p	15mA	377mA	87	1035µF
FEC15-48S15	36 – 75 VDC	15 VDC	0mA	1000mA	50mVp-p	15mA	381mA	86	705µF
FEC15-48D05	36 – 75 VDC	± 5 VDC	0mA	± 1500mA	75mVp-p	10mA	386mA	85	± 1020µF
FEC15-48D12	36 – 75 VDC	± 12 VDC	0mA	± 625mA	75mVp-p	15mA	372mA	88	± 495µF
FEC15-48D15	36 – 75 VDC	± 15 VDC	0mA	± 500mA	75mVp-p	15mA	377mA	87	± 165µF

Note

- BELLCORE TR-NWT-000332. Case 1: 50% Stress, Temperature at 40°C.
MIL-HDBK-217F Notice2 @Ta=25 °C, Full load(Ground, Benign, controlled environment).
- Maximum value at nominal input voltage and full load
- Typical value at nominal input voltage and no load.
- Typical value at nominal input voltage and full load.
- Test by minimum Vin and constant resistive load.
- The output requires a minimum loading on the output to maintain specified regulation. Operation under no-load condition will not damage these devices, however they may not meet all listed specification.
- The ON/OFF control pin voltage is referenced to -Vin.
To order positive logic ON-OFF control add the suffix-P (Ex: FEC15-24S05-P)
To order negative logic ON-OFF control add the suffix-N (Ex: FEC15-24S05-N)
- Heat sink is optional and P/N: 7G-0020C-F.
- The FEC15 series can meet EN55022 Class A with parallel an external capacitor to the input pins.
Recommend: 12Vin : 6.8µF/50V 1812 MLCC . 24Vin : 2.2µF/50V 1812 MLCC . 48Vin : 1.5µF/100V 1812 MLCC.
- An external input filter capacitor is required if the module has to meet EN61000-4-4, EN61000-4-5.
The filter capacitor Power Mate suggest: Nippon chemi-con KY series, 220 µ F/100V, ESR 48mΩ.

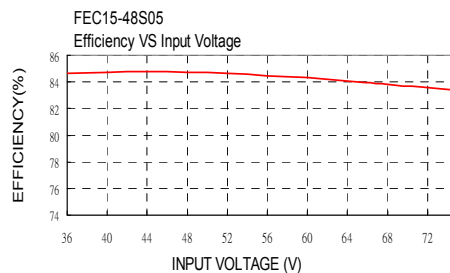
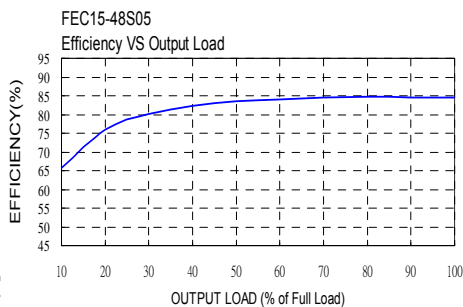
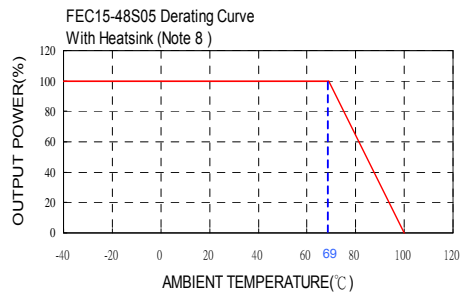
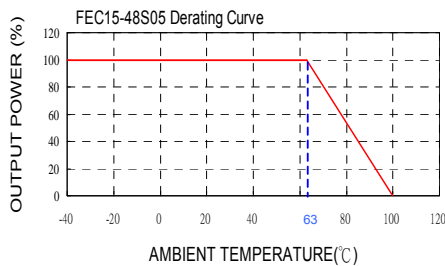

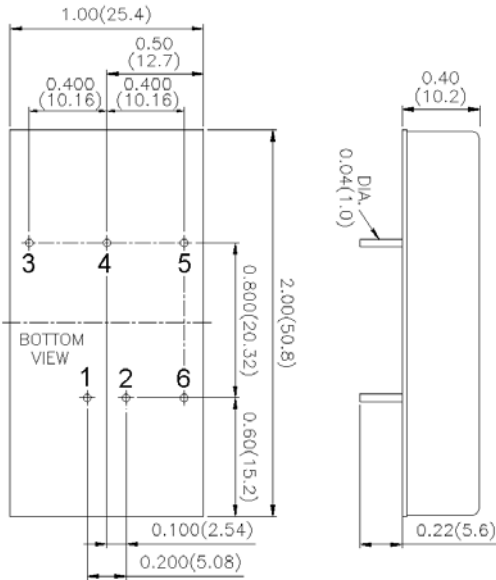

1. All dimensions in Inches (mm)
Tolerance: X.XX±0.02 (X.X±0.5)
X.XXX±0.01 (X.XX±0.25)
2. Pin pitch tolerance ±0.01(0.25)
3. Pin dimension tolerance ±0.004 (0.1)

PIN CONNECTION		
PIN	SINGLE	DUAL
1	+ INPUT	+ INPUT
2	- INPUT	- INPUT
3	+ OUTPUT	+ OUTPUT
4	NO PIN	COMMON
5	- OUTPUT	- OUTPUT
6	CTRL (Option)	CTRL (Option)

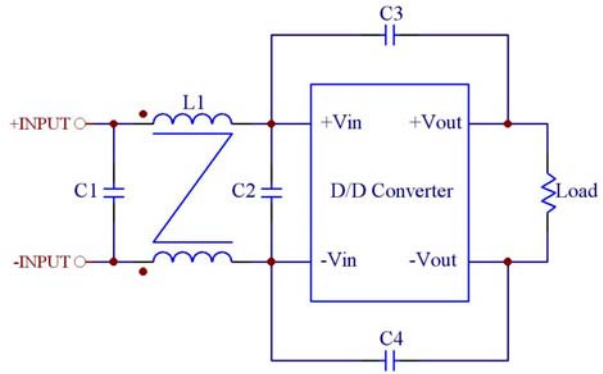

Recommended Filter for EN55022 Class B Compliance

The components used in the above figure, together with the manufacturers' part numbers for these components, are as follows:

	C1	C2	C3	C4	L1
FEC15-12xxx	4.7µF /50V 1812 MLCC	N/A	1000pF/2KV MLCC	1000pF/2KV MLCC	325µH Common Choke PMT-050
FEC15-24xxx	3.3µF /50V 1812 MLCC	N/A	1000pF/2KV MLCC	1000pF/2KV MLCC	325µH Common Choke PMT-050
FEC15-48xxx	2.2µF /100V 1812 MLCC	2.2µF /100V 1812 MLCC	1000pF/2KV MLCC	1000pF/2KV MLCC	325µH Common Choke PMT-050

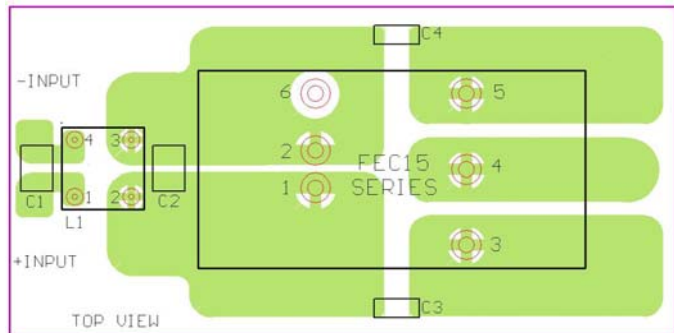

Recommended EN55022 Class B Filter Circuit Layout

