

FM120-MT THRU FM1200-MT

List

List.....	1
Package outline.....	2
Features.....	2
Mechanical data.....	2
Maximum ratings	2
Rating and characteristic curves.....	3
Pinning information.....	4
Marking.....	4
Suggested solder pad layout.....	4
Packing information.....	5
Reel packing.....	6
Suggested thermal profiles for soldering processes.....	6
High reliability test capabilities.....	7

FM120-MT THRU FM1200-MT

1.0A Surface Mount Schottky Barrier Rectifiers - 20V-200V

Features

- Batch process design, excellent power dissipation offers better reverse leakage current and thermal resistance.
- Low profile surface mounted application in order to optimize board space.
- Tiny plastic SMD package.
- Low power loss, high efficiency.
- High current capability, low forward voltage drop.
- High surge capability.
- Guardring for overvoltage protection.
- Ultra high-speed switching.
- Silicon epitaxial planar chip, metal silicon junction.
- Lead-free parts meet environmental standards of MIL-STD-19500 /228
- Suffix "-H" indicates Halogen-free part, ex.FM120-MT-H.

Mechanical data

- Epoxy : UL94-V0 rated flame retardant
- Case : Molded plastic, SOD-123T / MINI SMA
- Terminals :Plated terminals, solderable per MIL-STD-750, Method 2026
- Polarity : Indicated by cathode band
- Mounting Position : Any
- Weight : Approximated 0.018 gram

Package outline

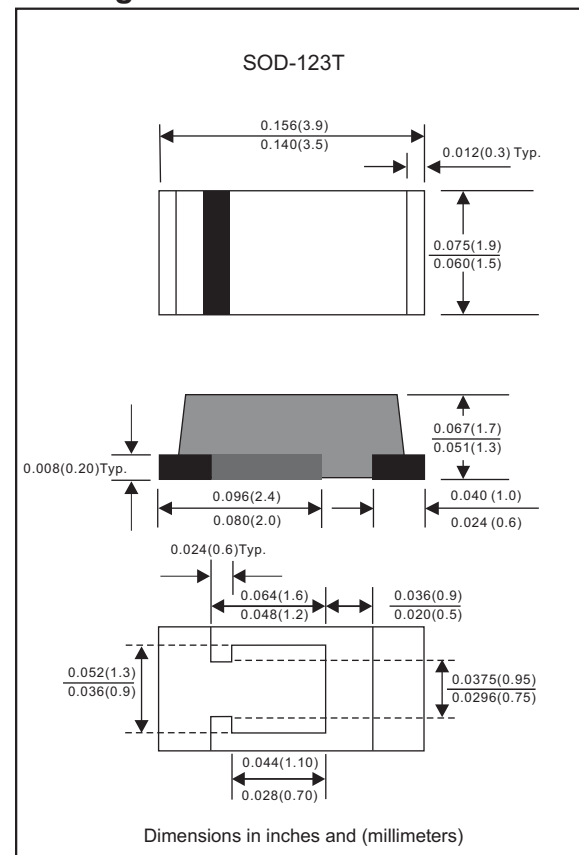

Maximum ratings and Electrical Characteristics (AT T_A=25°C unless otherwise noted)

PARAMETER	CONDITIONS	Symbol	MIN.	TYP.	MAX.	UNIT
Forward rectified current	See Fig.1	I _O			1.0	A
Forward surge current	8.3ms single half sine-wave (JEDEC methode)	I _{FSM}			30	A
Reverse current	V _R = V _{RRM} T _J = 25°C	I _R			0.2	mA
	V _R = V _{RRM} T _J = 100°C				10	
Thermal resistance	Junction to ambient	R _{θJA}		88		°C/W
	Junction to case	R _{θJC}		44		°C/W
Diode junction capacitance	f=1MHz and applied 4V DC reverse voltage	C _J		120		pF
Storage temperature		T _{STG}	-65		+175	°C

SYMBOLS	V _{RRM} *1 (V)	V _{RMS} *2 (V)	V _R *3 (V)	V _F *4 (V)	Operating temperature T _J , (°C)
FM120-MT	20	14	20	0.50	-55 to +125
FM130-MT	30	21	30		
FM140-MT	40	28	40		
FM150-MT	50	35	50	0.70	-55 to +150
FM160-MT	60	42	60		
FM180-MT	80	56	80	0.85	
FM1100-MT	100	70	100		
FM1150-MT	150	105	150	0.90	
FM1200-MT	200	140	200	0.92	

*1 Repetitive peak reverse voltage

*2 RMS voltage

*3 Continuous reverse voltage

*4 Maximum forward voltage@I_F=1.0A

Rating and characteristic curves (FM120-MT THRU FM1200-MT)

FIG.1-TYPICAL FORWARD CURRENT DERATING CURVE

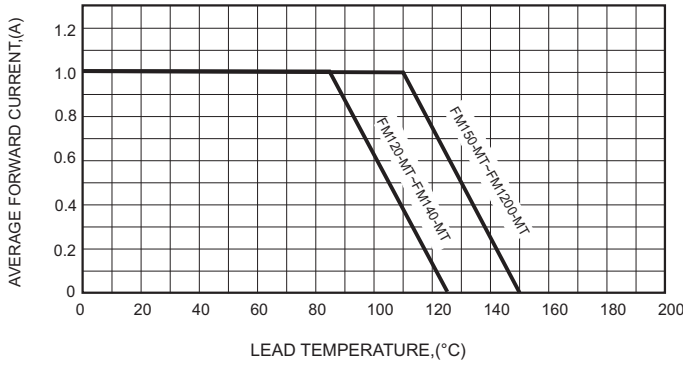

FIG.2-TYPICAL FORWARD CHARACTERISTICS

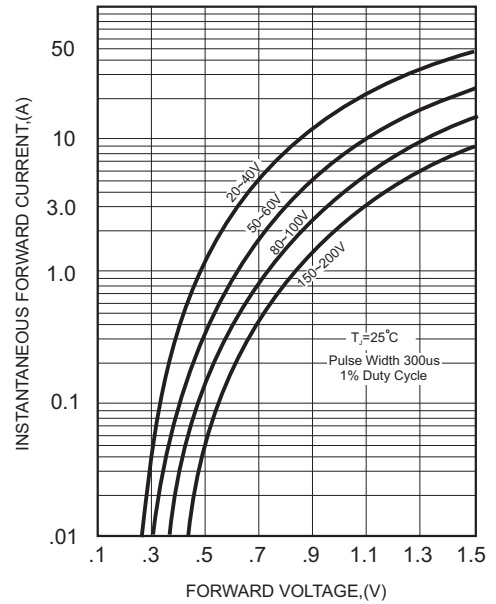

FIG.3-MAXIMUM NON-REPETITIVE FORWARD SURGE CURRENT

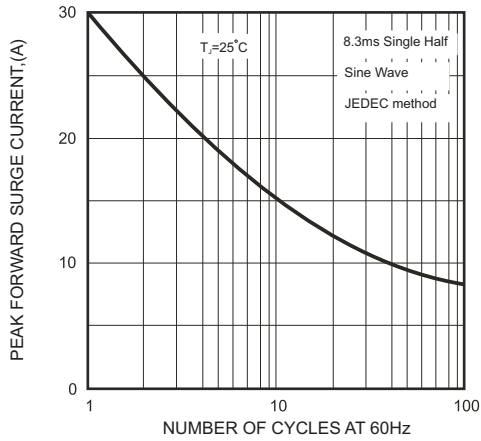

FIG.4-TYPICAL JUNCTION CAPACITANCE

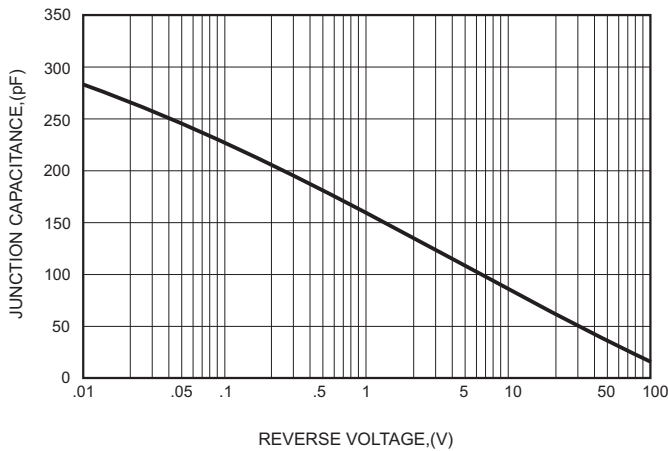
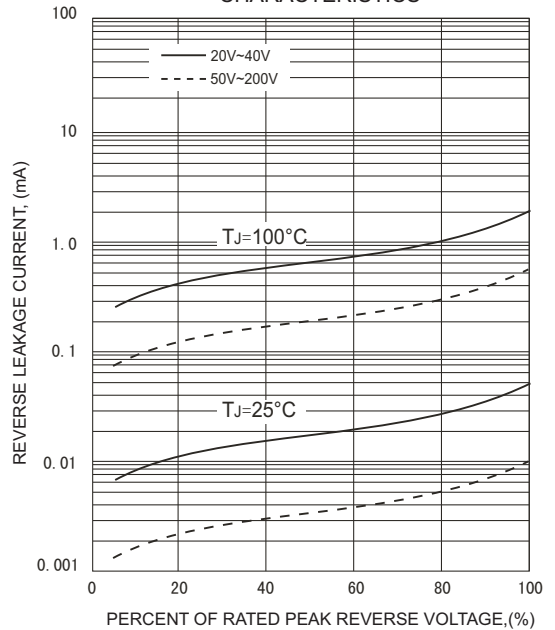



FIG.5 - TYPICAL REVERSE CHARACTERISTICS



FM120-MT THRU FM1200-MT

Pinning information

Pin	Simplified outline	Symbol
Pin1 cathode Pin2 anode		

Marking

Type number	Marking code
FM120-MT	12
FM130-MT	13
FM140-MT	14
FM150-MT	15
FM160-MT	16
FM180-MT	18
FM1100-MT	10
FM1150-MT	115
FM1200-MT	120

Suggested solder pad layout

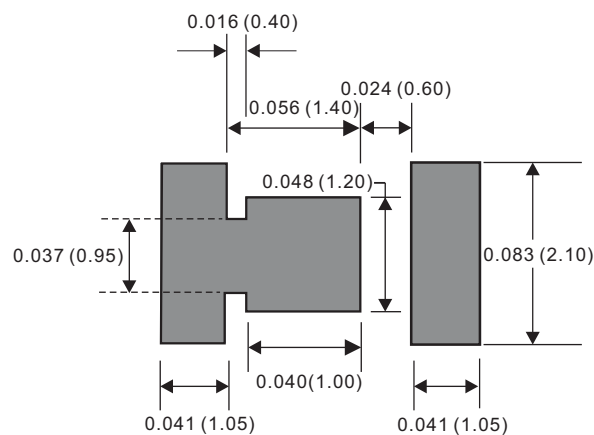

Dimensions in inches and (millimeters)

FM120-MT THRU FM1200-MT

Packing information

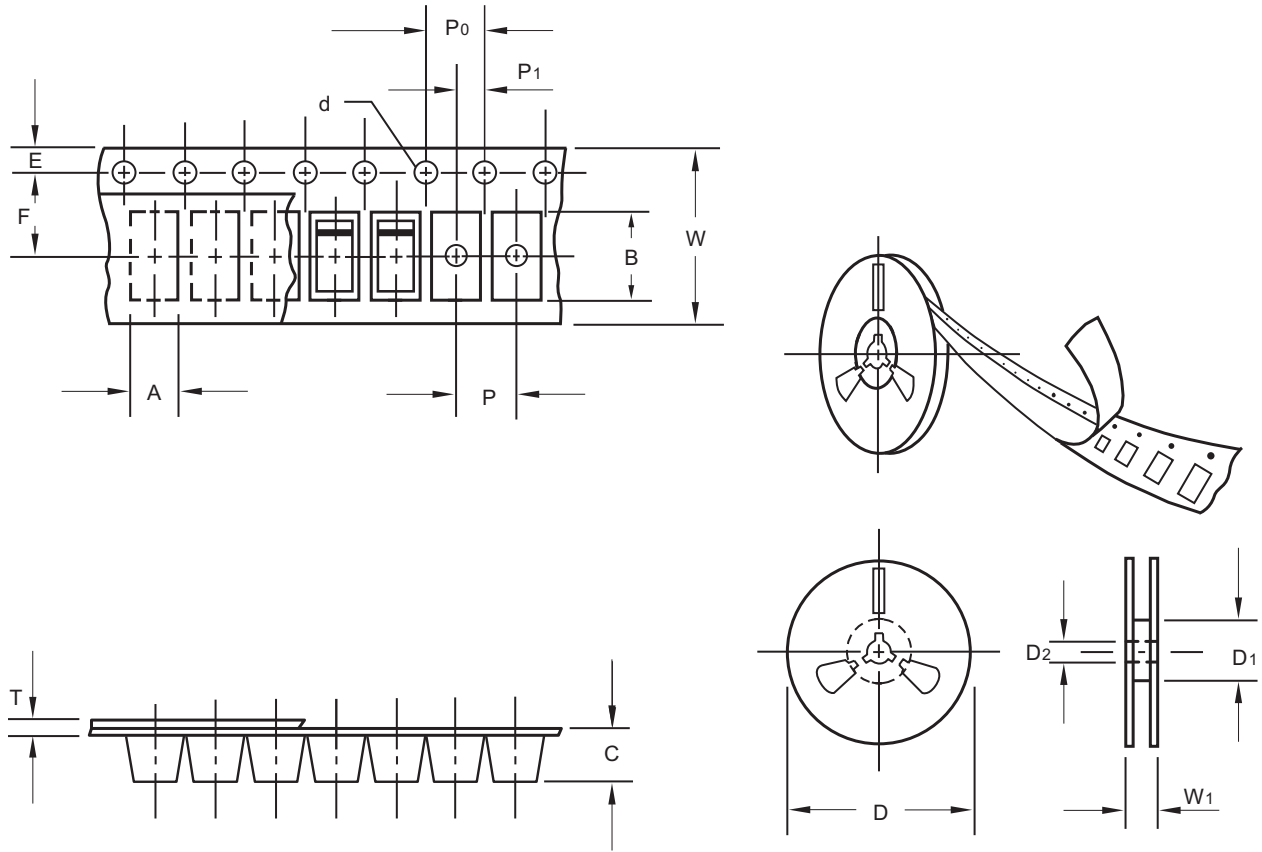

unit:mm

Item	Symbol	Tolerance	SOD-123T
Carrier width	A	0.1	1.90
Carrier length	B	0.1	3.90
Carrier depth	C	0.1	1.68
Sprocket hole	d	0.1	1.50
13" Reel outside diameter	D	2.0	-
13" Reel inner diameter	D1	min	-
7" Reel outside diameter	D	2.0	178.00
7" Reel inner diameter	D1	min	62.00
Feed hole diameter	D2	0.5	13.00
Sprocket hole position	E	0.1	1.75
Punch hole position	F	0.1	3.50
Punch hole pitch	P	0.1	4.00
Sprocket hole pitch	P0	0.1	4.00
Embossment center	P1	0.1	2.00
Overall tape thickness	T	0.1	0.23
Tape width	W	0.3	8.00
Reel width	W1	1.0	11.40

Note: Devices are packed in accordance with EIA standard RS-481-A and specifications listed above.

FM120-MT THRU FM1200-MT

Reel packing

PACKAGE	REEL SIZE	REEL (pcs)	COMPONENT SPACING (m/m)	BOX (pcs)	INNER BOX (m/m)	REEL DIA, (m/m)	CARTON SIZE (m/m)	CARTON (pcs)	APPROX. GROSS WEIGHT (kg)
SOD-123T	7"	2,500	4.0	25,000	183*183*123	178	382*262*387	200,000	9.5

Suggested thermal profiles for soldering processes

- 1.Storage environment: Temperature=5°C~40°C Humidity=55%±25%
- 2.Reflow soldering of surface-mount devices

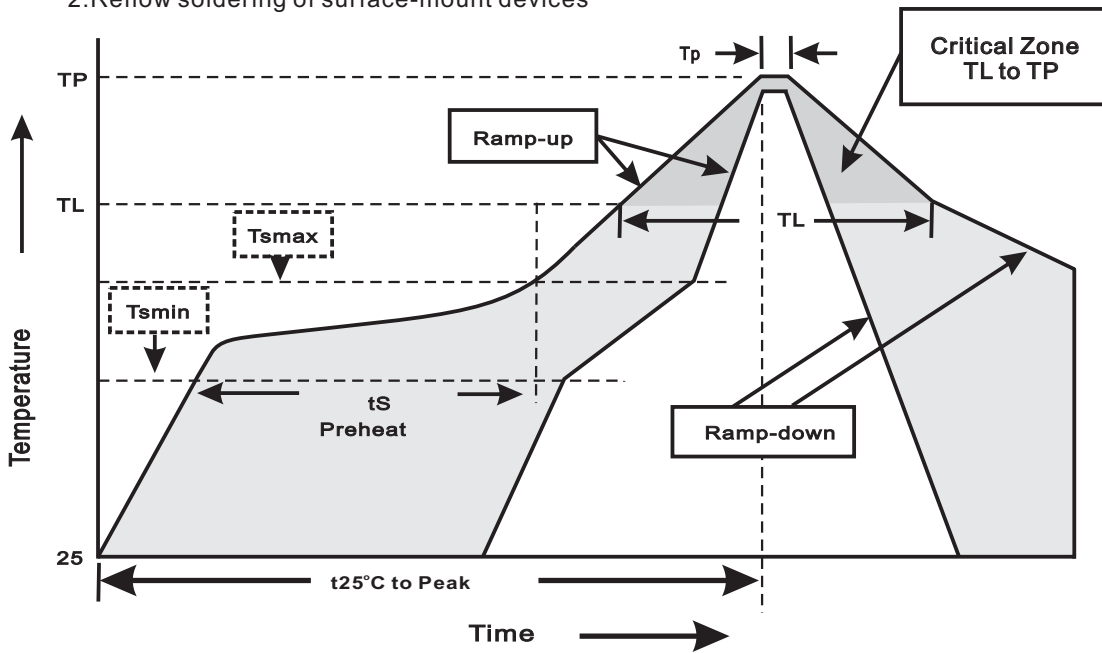

3.Reflow soldering

Profile Feature	Soldering Condition
Average ramp-up rate(T _L to T _P)	<3°C/sec
Preheat -Temperature Min(T _{smín}) -Temperature Max(T _{smáx}) -Time(min to max)(t _s)	150°C 200°C 60~120sec
T _{smáx} to T _L -Ramp-upRate	<3°C/sec
Time maintained above: -Temperature(T _L) -Time(t _L)	217°C 60~260sec
Peak Temperature(T _P)	255°C-0/+5°C
Time within 5°C of actual Peak Temperature(t _P)	10~30sec
Ramp-down Rate	<3°C/sec
Time 25°C to Peak Temperature	<6minutes

FM120-MT THRU FM1200-MT

High reliability test capabilities

Item Test	Conditions	Reference
1. Solder Resistance	at $260 \pm 5^\circ\text{C}$ for 10 ± 2 sec. immerse body into solder $1/16" \pm 1/32"$	MIL-STD-750D METHOD-2031
2. Solderability	at $245 \pm 5^\circ\text{C}$ for 5 sec.	MIL-STD-202F METHOD-208
3. High Temperature Reverse Bias	$V_R = 80\%$ rate at $T_J = 125^\circ\text{C}$ for 168 hrs.	MIL-STD-750D METHOD-1038
4. Forward Operation Life	Rated average rectifier current at $T_A = 25^\circ\text{C}$ for 500hrs.	MIL-STD-750D METHOD-1027
5. Intermittent Operation Life	$T_A = 25^\circ\text{C}$, $I_F = I_O$ On state: power on for 5 min. off state: power off for 5 min. on and off for 500 cycles.	MIL-STD-750D METHOD-1036
6. Pressure Cooker	$15P_{SIG}$ at $T_A = 121^\circ\text{C}$ for 4 hrs.	JESD22-A102
7. Temperature Cycling	-55°C to $+125^\circ\text{C}$ dwelled for 30 min. and transferred for 5min. total 10 cycles.	MIL-STD-750D METHOD-1051
8. Forward Surge	8.3ms single half sine-wave , one surge.	MIL-STD-750D METHOD-4066-2
9. Humidity	at $T_A = 85^\circ\text{C}$, RH=85% for 1000hrs.	MIL-STD-750D METHOD-1021
10. High Temperature Storage Life	at 175°C for 1000 hrs.	MIL-STD-750D METHOD-1031