

# FM240-MH1 THRU FM2200-MH1

## List

List.....	1
Package outline.....	2
Features.....	2
Mechanical data.....	2
Maximum ratings .....	2
Rating and characteristic curves.....	3
Pinning information.....	4
Marking.....	4
Suggested solder pad layout.....	4
Packing information.....	5
Reel packing.....	6
Suggested thermal profiles for soldering processes.....	6
High reliability test capabilities.....	7

# FM240-MH1 THRU FM2200-MH1

## 2.0A Surface Mount Schottky Barrier Rectifiers - 40V-200V

### Features

- Batch process design, excellent power dissipation offers better reverse leakage current and thermal resistance.
- Low profile surface mounted application in order to optimize board space.
- Tiny plastic SMD package.
- Low power loss, high efficiency.
- High current capability, low forward voltage drop.
- High surge capability.
- Guardring for overvoltage protection.
- Ultra high-speed switching.
- Silicon epitaxial planar chip, metal silicon junction.
- Lead-free parts meet environmental standards of MIL-STD-19500 /228
- Suffix "-H" indicates Halogen free parts, ex. FM240-MH1-H.

### Mechanical data

- Epoxy : UL94-V0 rated flame retardant
- Case : Molded plastic, SOD-123H1
- Terminals :Plated terminals, solderable per MIL-STD-750, Method 2026
- Polarity : Indicated by cathode band
- Mounting Position : Any
- Weight : Approximated 0.0103 gram

### Package outline

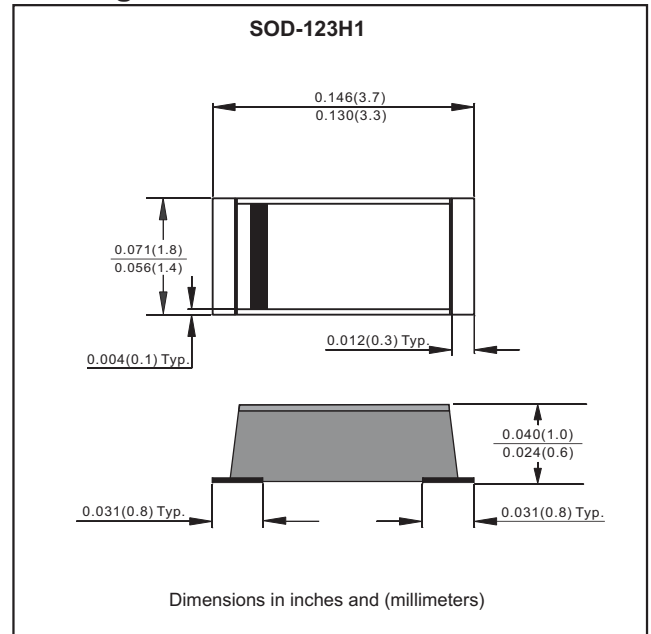

### Maximum ratings and Electrical Characteristics (AT $T_A=25^{\circ}\text{C}$ unless otherwise noted)

PARAMETER	SYMBOLS	FM240-MH1	FM260-MH1	FM2100-MH1	FM2150-MH1	FM2200-MH1	UNITS
Maximum repetitive peak reverse voltage	$V_{RRM}$	40	60	100	150	200	Volts
Maximum RMS voltage	$V_{RMS}$	28	42	70	105	140	Volts
Maximum DC blocking voltage	$V_{DC}$	40	60	100	150	200	Volts
Maximum average forward rectified current	$I_o$	2.0					Amps
Peak forward surge current 8.3ms single half sine-wave (JEDEC Method)	$I_{FSM}$	50					Amps
Maximum instantaneous forward voltage at $I_f=2.0A$	$V_f$	0.50	0.70	0.85	0.90	0.92	Volts
Maximum DC reverse current at rated DC blocking voltage	$I_R$	0.5 10					mA
Typical junction capacitance (Note 1)	$C_J$	160					pF
Typical thermal resistance junction to ambient	$R_{\theta JA}$	76					$^{\circ}\text{C} / \text{W}$
Typical thermal resistance junction to case	$R_{\theta JC}$	38					$^{\circ}\text{C} / \text{W}$
Operating junction temperature range	$T_J$	-55 to +125	-55 to +150				$^{\circ}\text{C}$
Storage temperature range	$T_{STG}$	-55 to +150					$^{\circ}\text{C}$

Notes 1: Measured at 1.0 MHz and applied reverse voltage of 4.0 Volts

# Rating and characteristic curves (FM240-MH1 THRU FM2200-MH1)

FIG.1-TYPICAL FORWARD CURRENT DERATING CURVE

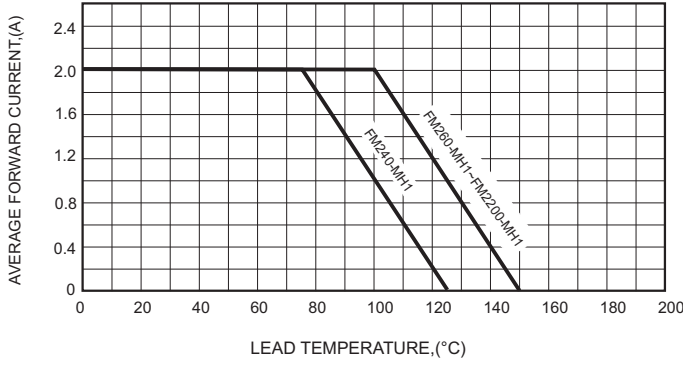

FIG.2-TYPICAL FORWARD CHARACTERISTICS

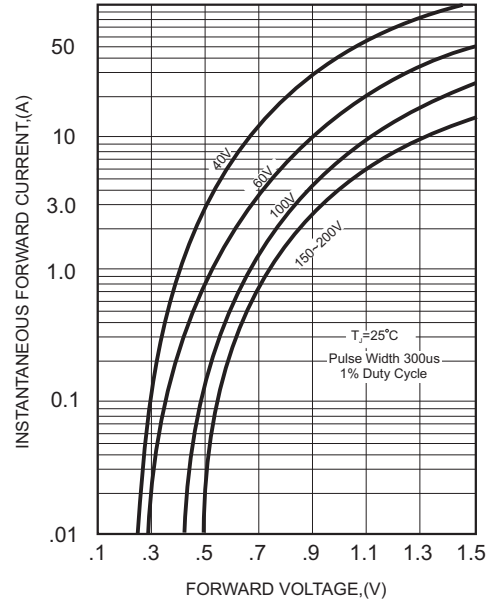

FIG.3-MAXIMUM NON-REPETITIVE FORWARD SURGE CURRENT

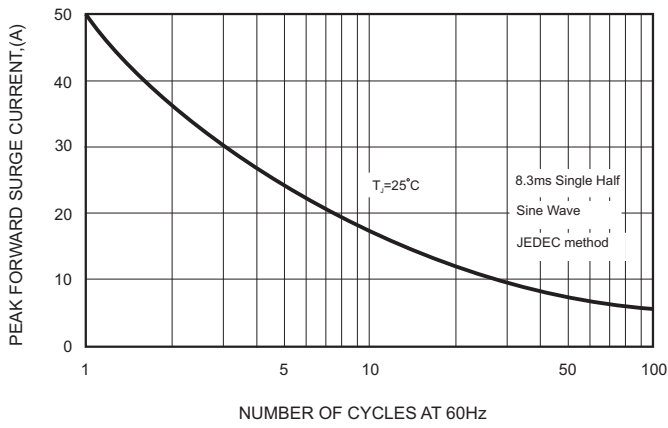

FIG.5 - TYPICAL REVERSE CHARACTERISTICS

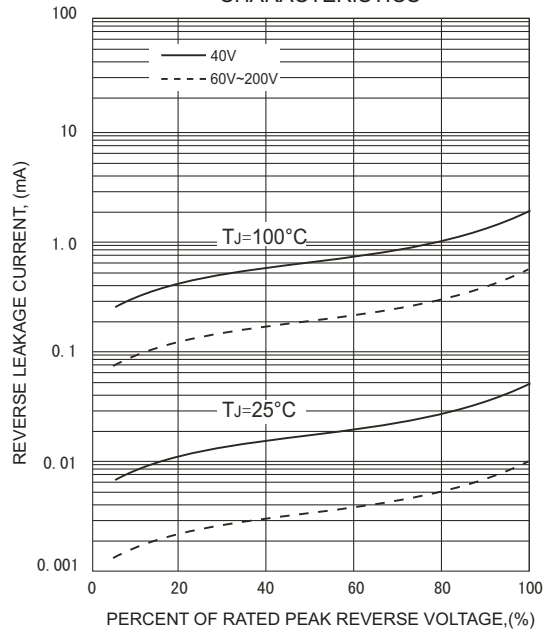
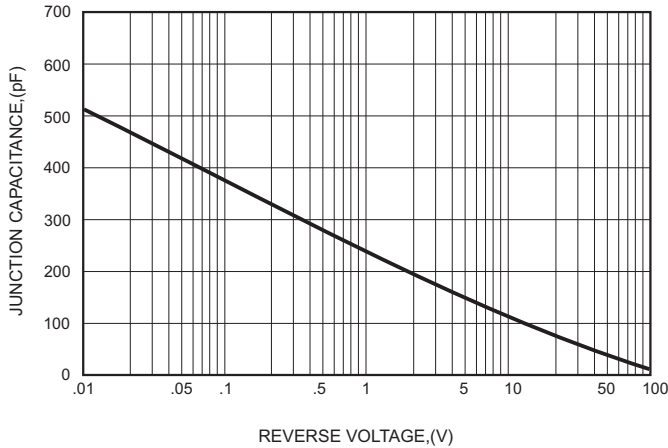



FIG.4-TYPICAL JUNCTION CAPACITANCE



# FM240-MH1 THRU FM2200-MH1

## Pinning information

Pin	Simplified outline	Symbol
Pin1 cathode Pin2 anode		

## Marking

Type number	Marking code
FM240-MH1	24
FM260-MH1	26
FM2100-MH1	20
FM2150-MH1	215
FM2200-MH1	220

## Suggested solder pad layout

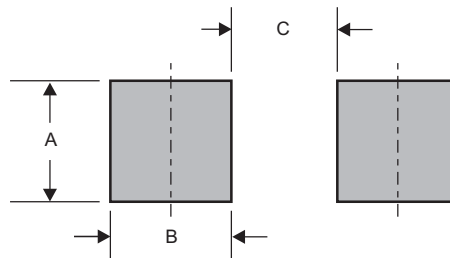

Dimensions in inches and (millimeters)

PACKAGE	A	B	C
SOD-123H1	0.071 (1.80)	0.051 (1.30)	0.067 (1.70)

# FM240-MH1 THRU FM2200-MH1

## Packing information

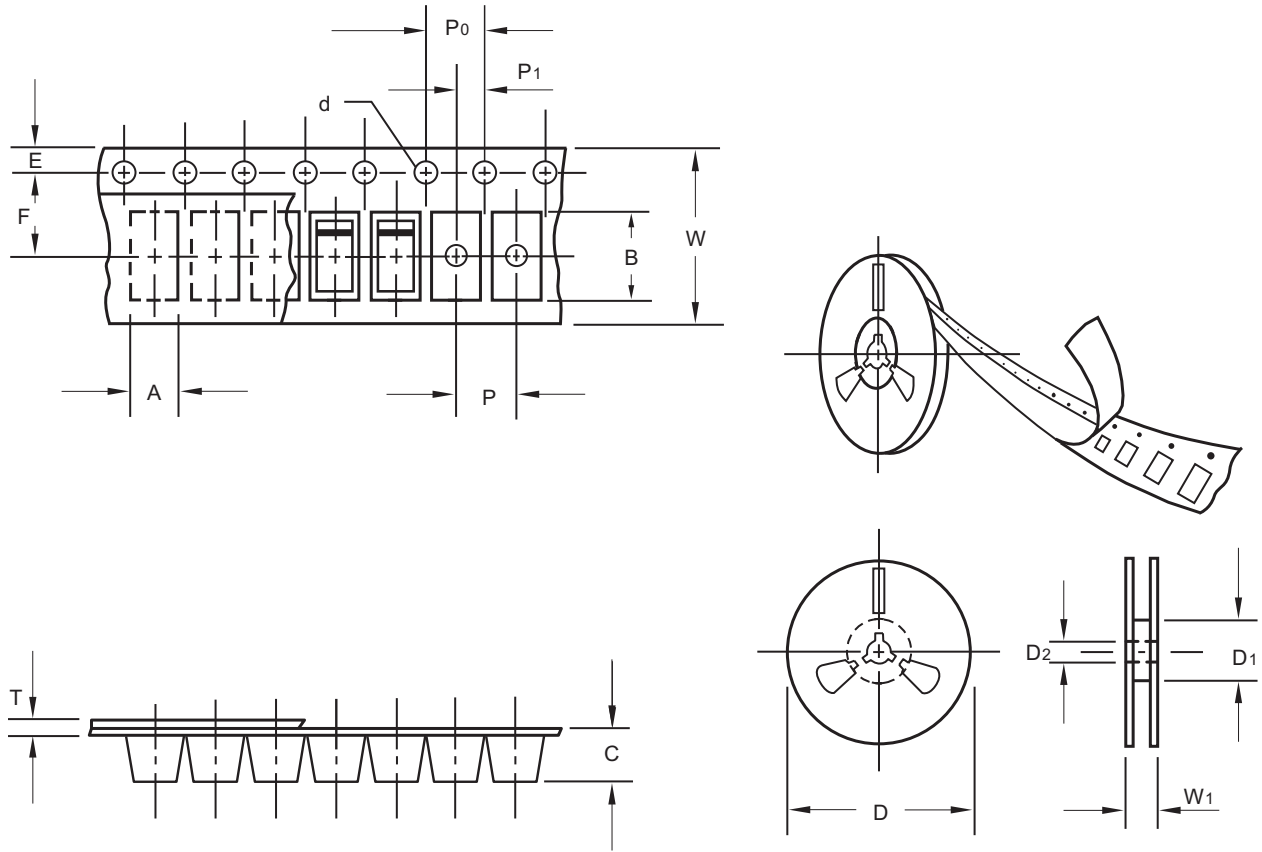

unit:mm

Item	Symbol	Tolerance	SOD-123H1
Carrier width	A	0.1	2.00
Carrier length	B	0.1	3.85
Carrier depth	C	0.1	1.10
Sprocket hole	d	0.1	1.50
13" Reel outside diameter	D	2.0	-
13" Reel inner diameter	D1	min	-
7" Reel outside diameter	D	2.0	178.00
7" Reel inner diameter	D1	min	62.00
Feed hole diameter	D2	0.5	13.00
Sprocket hole position	E	0.1	1.75
Punch hole position	F	0.1	3.50
Punch hole pitch	P	0.1	4.00
Sprocket hole pitch	P0	0.1	4.00
Embossment center	P1	0.1	2.00
Overall tape thickness	T	0.1	0.23
Tape width	W	0.3	8.00
Reel width	W1	1.0	11.40

Note: Devices are packed in accordance with EIA standard RS-481-A and specifications listed above.

# FM240-MH1 THRU FM2200-MH1

## Reel packing

PACKAGE	REEL SIZE	REEL (pcs)	COMPONENT SPACING (m/m)	BOX (pcs)	INNER BOX (m/m)	REEL DIA, (m/m)	CARTON SIZE (m/m)	CARTON (pcs)	APPROX. GROSS WEIGHT (kg)
SOD-123H1	7"	3,000	4.0	30,000	183*183*123	178	382*262*387	240,000	8.5

## Suggested thermal profiles for soldering processes

- 1.Storage environment: Temperature=5°C~40°C Humidity=55%±25%
- 2.Reflow soldering of surface-mount devices

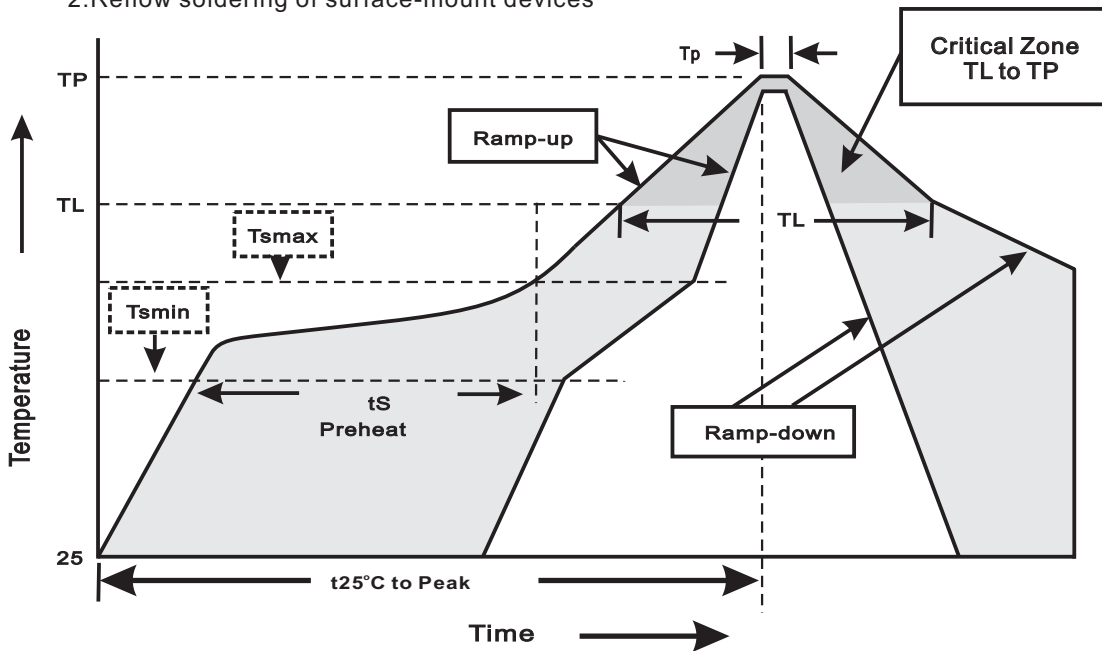

### 3.Reflow soldering

Profile Feature	Soldering Condition
Average ramp-up rate(T <sub>L</sub> to T <sub>P</sub> )	<3°C/sec
Preheat -Temperature Min(T <sub>smmin</sub> ) -Temperature Max(T <sub>smmax</sub> ) -Time(min to max)(t <sub>s</sub> )	150°C 200°C 60~120sec
T <sub>smmax</sub> to T <sub>L</sub> -Ramp-upRate	<3°C/sec
Time maintained above: -Temperature(T <sub>L</sub> ) -Time(t <sub>L</sub> )	217°C 60~260sec
Peak Temperature(T <sub>P</sub> )	255°C-0/+5°C
Time within 5°C of actual Peak Temperature(t <sub>P</sub> )	10~30sec
Ramp-down Rate	<6°C/sec
Time 25°C to Peak Temperature	<6minutes

**FM240-MH1 THRU FM2200-MH1****High reliability test capabilities**

Item Test	Conditions	Reference
1. Solder Resistance	at $260\pm 5^{\circ}\text{C}$ for $10\pm 2\text{sec}$ . immerse body into solder $1/16''\pm 1/32''$	MIL-STD-750D METHOD-2031
2. Solderability	at $245\pm 5^{\circ}\text{C}$ for 5 sec.	MIL-STD-202F METHOD-208
3. High Temperature Reverse Bias	$V_R=80\%$ rate at $T_J=125^{\circ}\text{C}$ for 168 hrs.	MIL-STD-750D METHOD-1038
4. Forward Operation Life	Rated average rectifier current at $T_A=25^{\circ}\text{C}$ for 500hrs.	MIL-STD-750D METHOD-1027
5. Intermittent Operation Life	$T_A = 25^{\circ}\text{C}$ , $I_F = I_o$ On state: power on for 5 min. off state: power off for 5 min. on and off for 500 cycles.	MIL-STD-750D METHOD-1036
6. Pressure Cooker	$15P_{SIG}$ at $T_A=121^{\circ}\text{C}$ for 4 hrs.	JESD22-A102
7. Temperature Cycling	$-55^{\circ}\text{C}$ to $+125^{\circ}\text{C}$ dwelled for 30 min. and transferred for 5min. total 10 cycles.	MIL-STD-750D METHOD-1051
8. Forward Surge	8.3ms single half sine-wave , one surge.	MIL-STD-750D METHOD-4066-2
9. Humidity	at $T_A=85^{\circ}\text{C}$ , RH=85% for 1000hrs.	MIL-STD-750D METHOD-1021
10. High Temperature Storage Life	at $175^{\circ}\text{C}$ for 1000 hrs.	MIL-STD-750D METHOD-1031