

FM4005

Glass passivated type

Features

- Plastic package has Underwriters Laboratory Flammability Classification 94V-O Utilizing Flame Retardant Epoxy Molding Compound.
- For surface mounted applications.
- Exceeds environmental standards of MIL-S-19500 / 228
- Low leakage current.

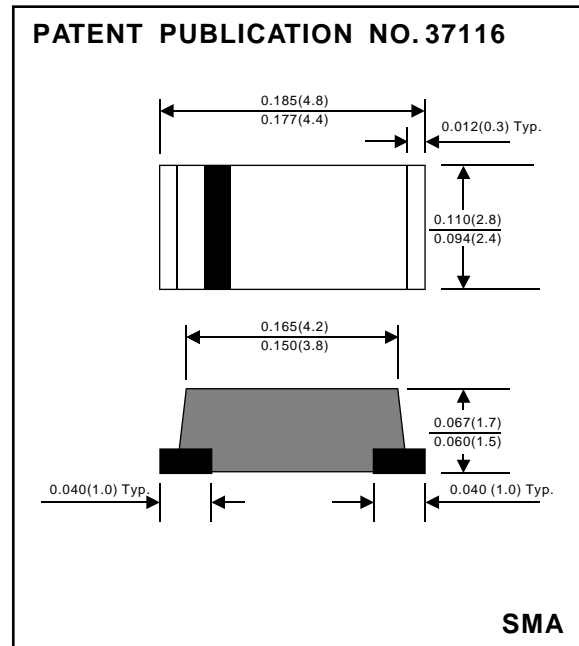

Mechanical data

Case : Molded plastic, JEDEC DO-214AC

Terminals : Solder plated, solderable per MIL-STD-750, Method 2026

Polarity : Indicated by cathode band

Mounting Position : Any

Weight : 0.0015 ounce, 0.05 gram

MARKING CODE : A5

MAXIMUM RATINGS (AT $T_A=25^{\circ}\text{C}$ unless otherwise noted)

PARAMETER	CONDITIONS	Symbol	MI N.	TYP.	MAX.	UNI T
Repetitive peak reverse voltage		V_{RRM}			600	V
RMS voltage		V_{RMS}			420	V
Continuous reverse voltage		V_R			600	V
Forward rectified current	Lead temperature = 70°C	I_O			1.0	A
Forward surge current	8.3ms single half sine-wave superimposed on rate load (JEDEC method)	I_{FSM}			30	A
Thermal resistance	Junction to ambient	$R_{\theta JA}$			100	$^{\circ}\text{C} / \text{w}$
Diode junction capacitance	$f=1\text{MHz}$ and applied 4vDC reverse voltage	C_J		15		pF
Operating temperature		T_J	-55		+150	$^{\circ}\text{C}$
Storage temperature		T_{STG}	-55		+150	$^{\circ}\text{C}$

ELECTRICAL CHARACTERISTICS (AT $T_A=25^{\circ}\text{C}$ unless otherwise noted)

PARAMETER	CONDITIONS	Symbol	MI N.	TYP.	MAX.	UNI T
Forward voltage	$I_F = 1.0 \text{ AMPERE DC}$	V_F			1.10	V
Reverse current	$V_R = \text{Peak reverse voltage } T_A = 25^{\circ}\text{C}$	I_R			5	μA
	$V_R = \text{Peak reverse voltage } T_A = 125^{\circ}\text{C}$				50	μA