

FMM5056VF

5.8-7.2GHz Power Amplifier MMIC

FEATURES

- High Output Power: 34.0dBm(typ.)
- High Linear Gain: 28.0dB(typ.)
- Low VSWR
- Broad Band: 5.8 ~ 7.2GHz
- Impedance Matched $Z_{in}/Z_{out} = 50\Omega$
- Small Hermetic Metal-Ceramic Package(VF)

DESCRIPTION

The FMM5056VF is a MMIC amplifier that contains a four-stage amplifier, internally matched, for standard communications band in the 5.8 to 7.2GHz frequency range.

Fujitsu's stringent Quality Assurance Program assures the highest reliability and consistent performance.

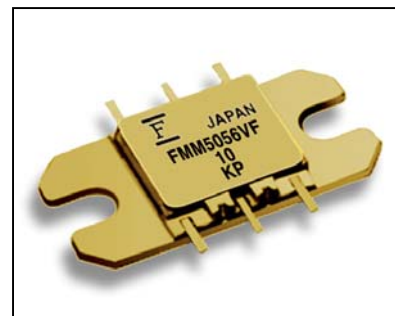

ABSOLUTE MAXIMUM RATINGS (Case Temperature $T_c=25^\circ\text{C}$)

Item	Symbol	Rating	Unit
DC Input Voltage	V_{DD}	12	V
DC Input Voltage	V_{GG}	-7	V
Input Power	P_{in}	12	dBm
Storage Temperature	T_{stg}	-55 to +125	$^\circ\text{C}$

Recommended Operating Condition

Item	Symbol	Condition	Unit
DC Input Voltage at $T_c=25^\circ\text{C}$	V_{DD}	10	V
Input Power at $T_c=25^\circ\text{C}$	P_{in}	10	dBm
DC Input Current at $T_c=25^\circ\text{C}$	I_{DD}	≤ 1200	mA
Operating Case Temperature	T_c	-40 to +85	$^\circ\text{C}$

ELECTRICAL CHARACTERISTICS (Case Temperature $T_c=25^\circ\text{C}$)

Item	Symbol	Test Conditions	Limit			Unit
			Min.	Typ.	Max.	
Frequency Range	f		5.8 - 7.2			GHz
Output Power at 1dB G.C.P.	P_{1dB}	$V_{DD}=10\text{V}$ $V_{GG}=-5\text{V}$ $f=5.8 \text{ to } 7.2\text{GHz}$	32.0	34.0	-	dBm
Power Gain at 1dB G.C.P.	G_{1dB}		25.0	28.0	-	dB
Gain Flatness	ΔG		-	2.4	4.0	dB
Input VSWR	$VSWR_i$		-	2 : 1	2.6 : 1	-
Output VSWR	$VSWR_o$		-	2 : 1	-	-
DC Input Current	I_{DD}	$V_{DD}=10\text{V}, V_{GG}=-5\text{V}$	-	1100	1200	mA
DC Input Current	I_{GG}		-	5.0	15.0	mA
Channel Temperature Rise	ΔT_{ch}		-	50	-	$^\circ\text{C}$

CASE STYLE: VF

Note: G_{1dB} is referenced to Linear Gain measured at $P_{in}=-5\text{dBm}$

G.C.P.: Gain Compression Point

ESD	Class 0	~ 199 V
-----	---------	---------

Note : Based on EIAJ ED-4701 C-111A(C=100pF, R=1.5k Ω)

FMM5056VF

5.8-7.2GHz Power Amplifier MMIC

OUTPUT POWER vs. FREQUENCY

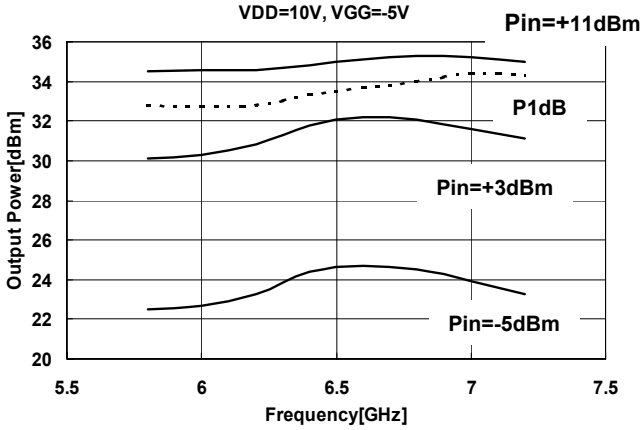

OUTPUT POWER, POWER ADDED EFFICIENCY vs. INPUT POWER

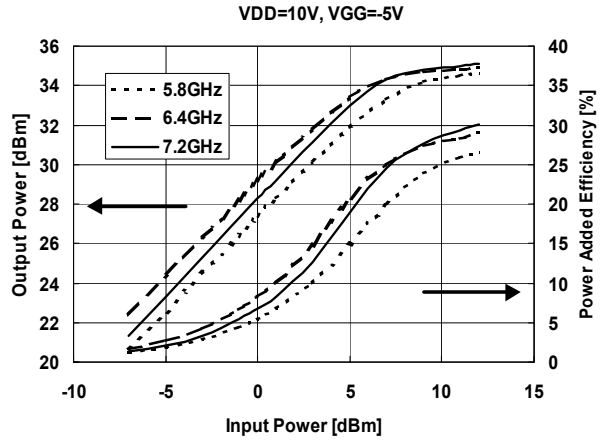

IMD vs. OUTPUT POWER(S.C.L.)

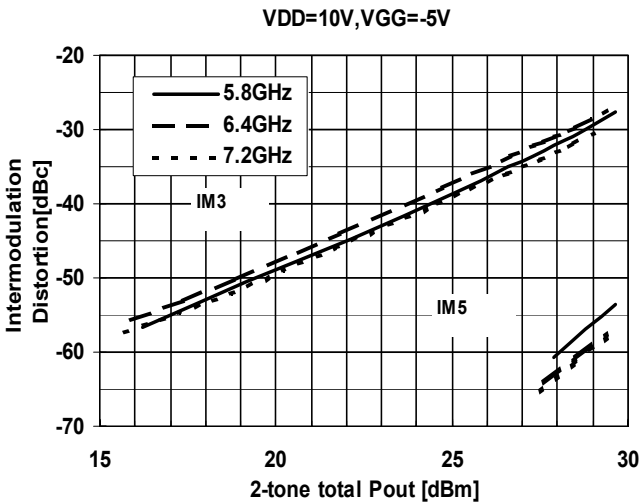

VSWR vs. FREQUENCY

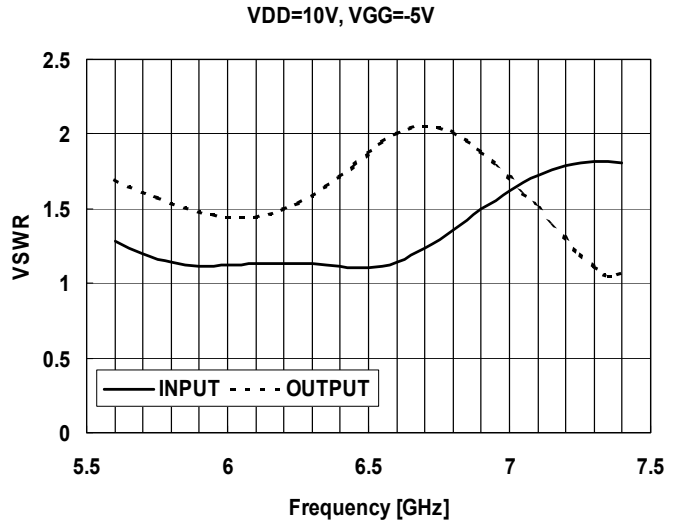

FMM5056VF

5.8-7.2GHz Power Amplifier MMIC

DRAIN CURRENT vs OUTPUT POWER

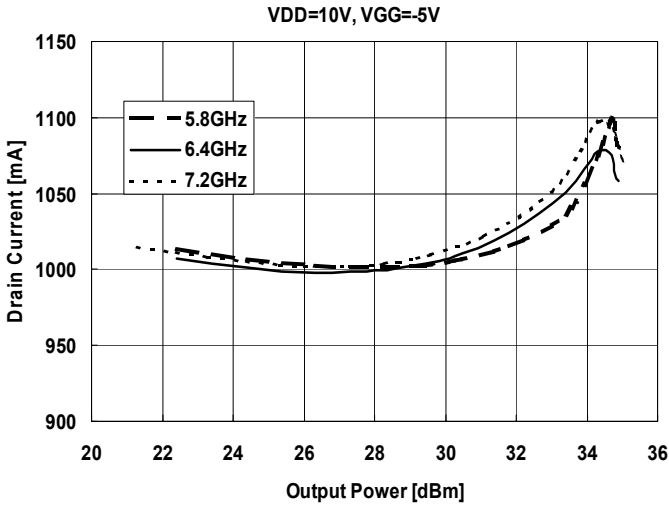

AMPM vs OUTPUT POWER

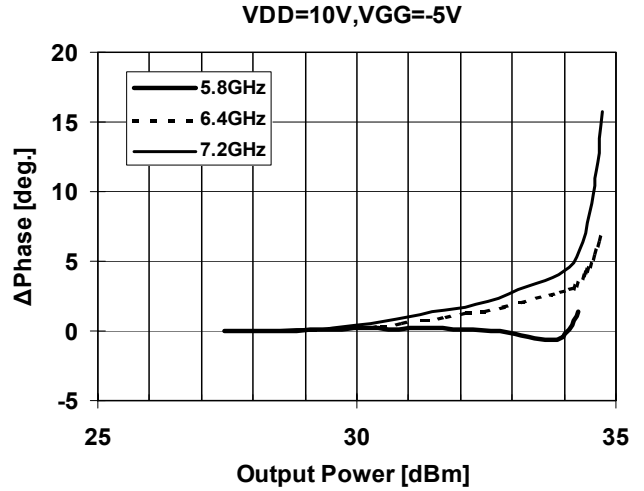

OUTPUT POWER vs. DRAIN VOLTAGE

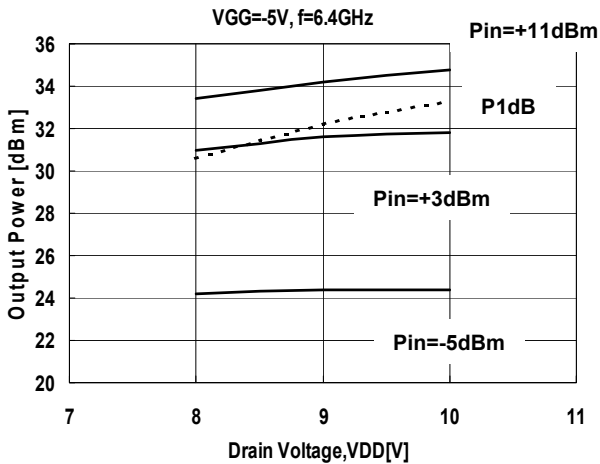

DRAIN CURRENT vs OUTPUT POWER

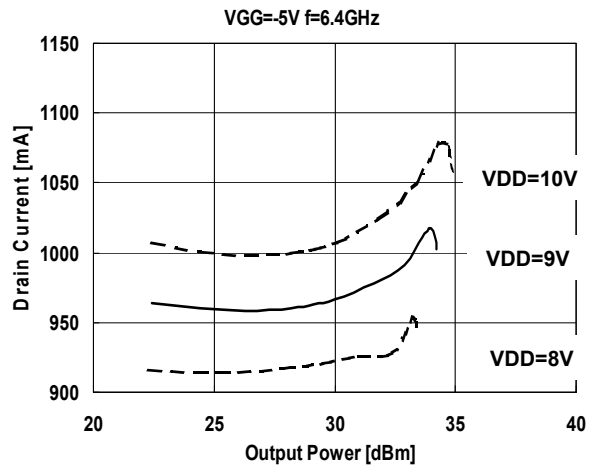

FMM5056VF

5.8-7.2GHz Power Amplifier MMIC

OUTPUT POWER , POWER ADDED EFFICIENCY vs. INPUT POWER

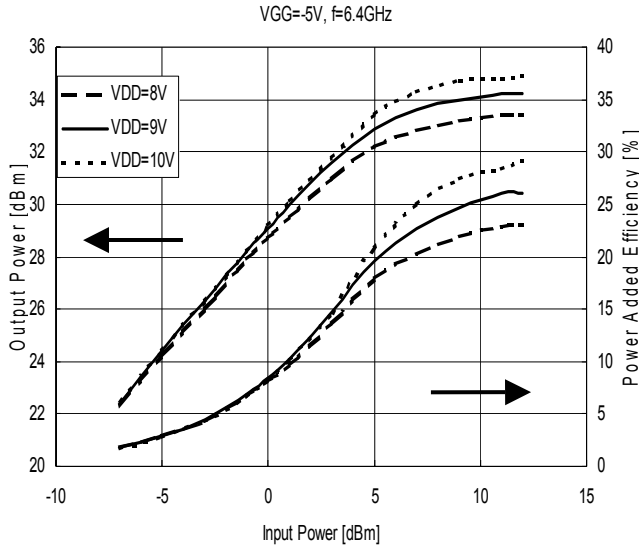

OUTPUT POWER , POWER ADDED EFFICIENCY vs. INPUT POWER

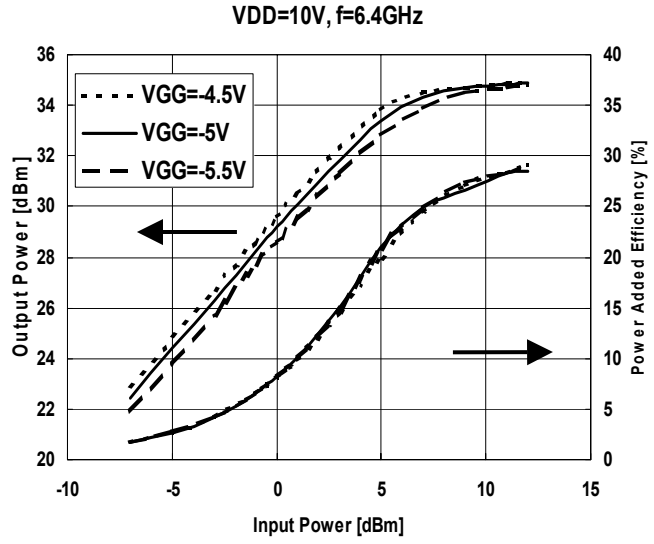

DRAIN CURRENT vs. OUTPUT POWER

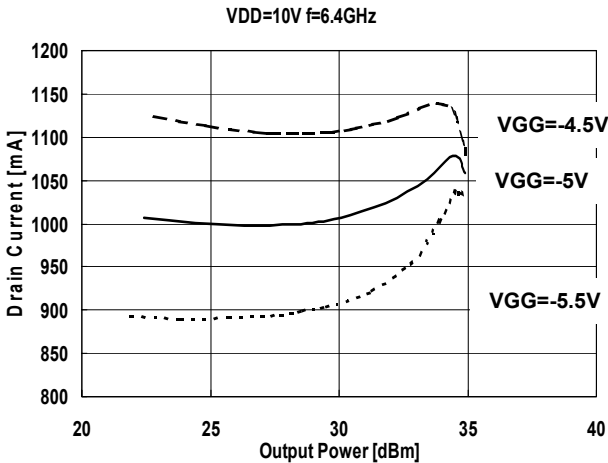

OUTPUT POWER vs. GATE VOLTAGE

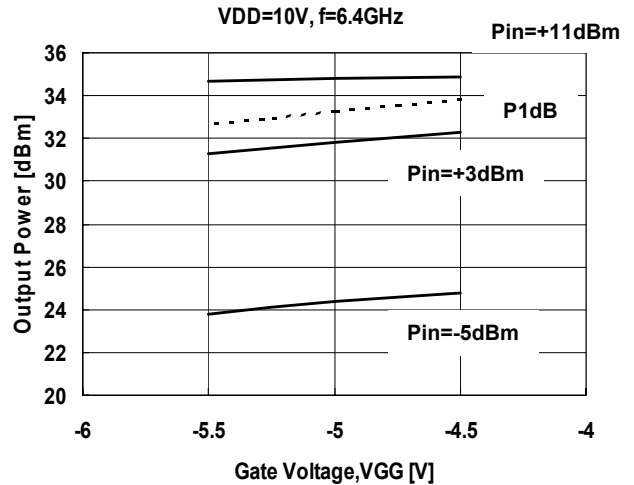

FMM5056VF

5.8-7.2GHz Power Amplifier MMIC

■ S-PARAMETER

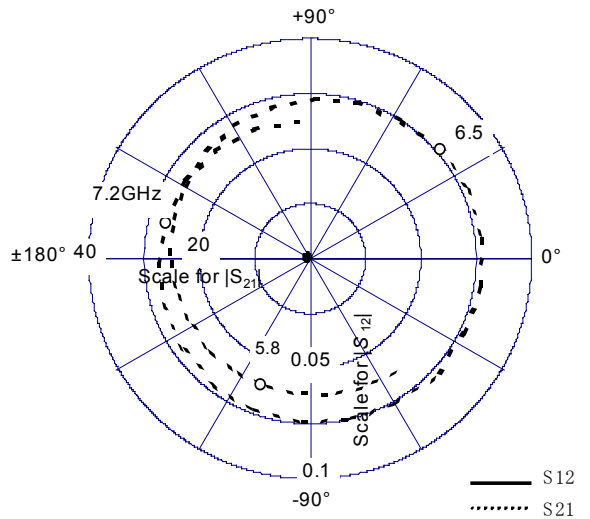
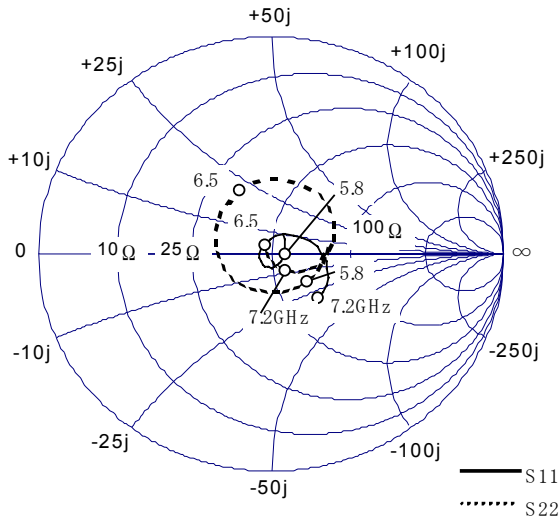

VDD=10.0V, VGG=-5.0V

Frequency [GHz]	S11		S21		S12		S22	
	MAG	ANG	MAG	ANG	MAG	ANG	MAG	ANG
5.6	0.11	60.30	25.75	-53.50	0.0013	-167.09	0.24	3.68
5.7	0.08	36.46	24.87	-83.02	0.0013	-168.43	0.22	-16.53
5.8	0.06	3.99	24.46	-111.49	0.0011	-159.93	0.20	-39.28
5.9	0.05	-32.63	24.49	-139.66	0.0012	-157.97	0.19	-65.48
6	0.06	-63.96	24.97	-167.78	0.0013	-154.12	0.18	-95.80
6.1	0.06	-89.50	25.80	163.81	0.0014	-154.94	0.19	-127.81
6.2	0.06	-113.38	27.01	134.51	0.0016	-156.94	0.21	-159.39
6.3	0.06	-140.43	28.37	104.22	0.0018	-161.66	0.24	170.47
6.4	0.05	178.94	29.70	72.78	0.0021	-170.22	0.28	141.84
6.5	0.05	121.67	30.74	40.05	0.0024	-178.69	0.32	114.82
6.6	0.08	74.14	31.19	6.88	0.0026	169.54	0.34	88.83
6.7	0.13	42.82	31.06	-26.88	0.0026	157.81	0.34	63.73
6.8	0.18	19.89	30.58	-60.37	0.0026	144.13	0.32	40.09
6.9	0.22	0.51	29.67	-93.74	0.0026	132.25	0.29	17.13
7	0.25	-16.23	28.78	-127.22	0.0024	118.43	0.23	-4.92
7.1	0.28	-31.24	27.80	-160.64	0.0020	110.25	0.17	-27.22
7.2	0.29	-45.18	26.86	165.59	0.0017	98.22	0.09	-51.99
7.3	0.29	-58.16	25.84	130.81	0.0014	91.48	0.02	-122.39

FMM5056VF

5.8-7.2GHz Power Amplifier MMIC

■ Recommended Bias Circuit and Internal Block Diagram

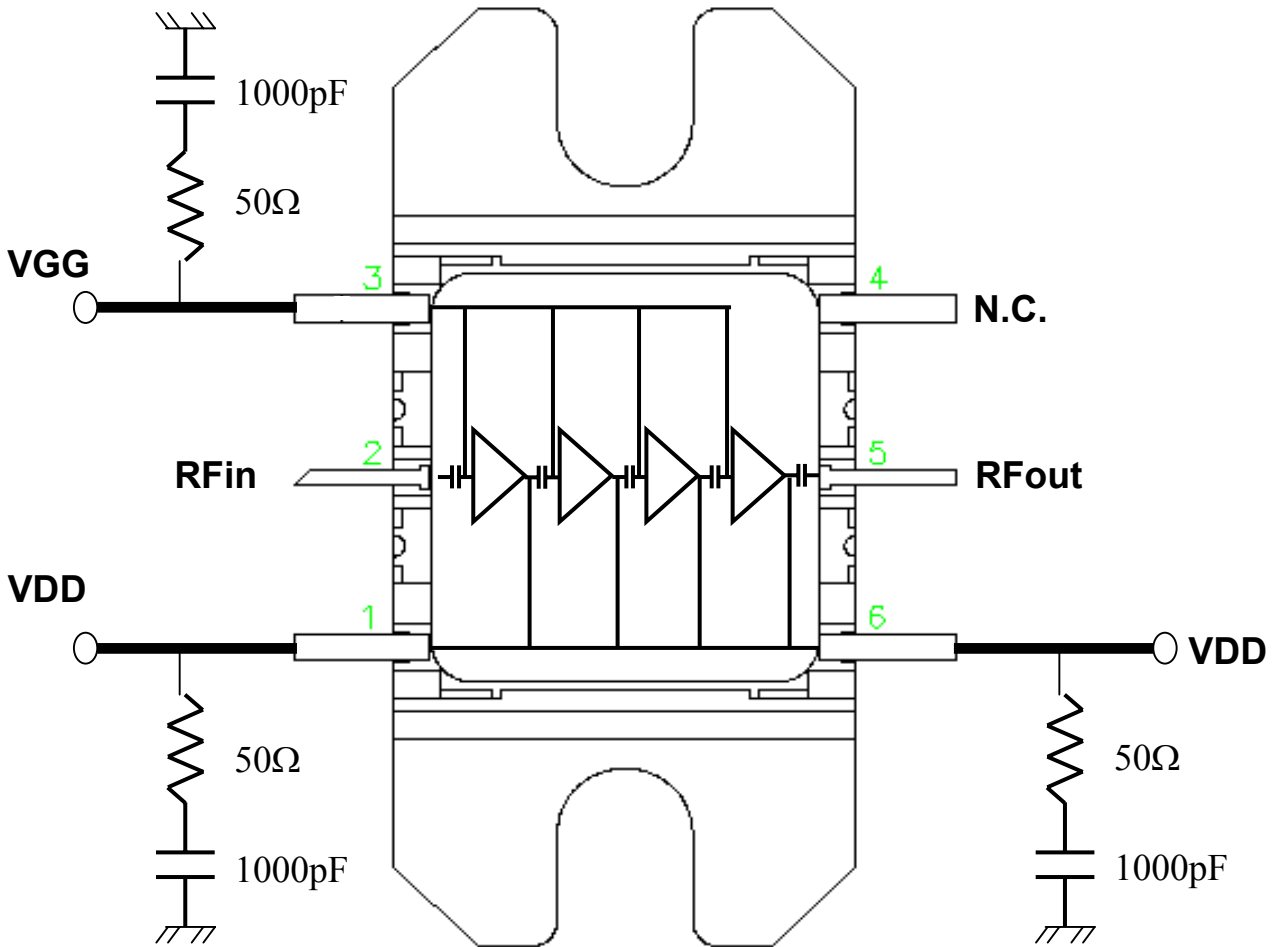

Note 1: The RC networks are recommended on the bias supply lines, close to the package, to prevent video oscillations which could damage the module.

Note 2: Bias point VDD can be connected at the input side or at the output. The two pins named VDD are internally connected.

PIN ASSIGNMENT

- 1 : VDD
- 2 : RF in
- 3 : VGG
- 4 : N.C.
- 5 : RF out
- 6 : VDD

FMM5056VF

5.8-7.2GHz Power Amplifier MMIC

■ Package Out Line

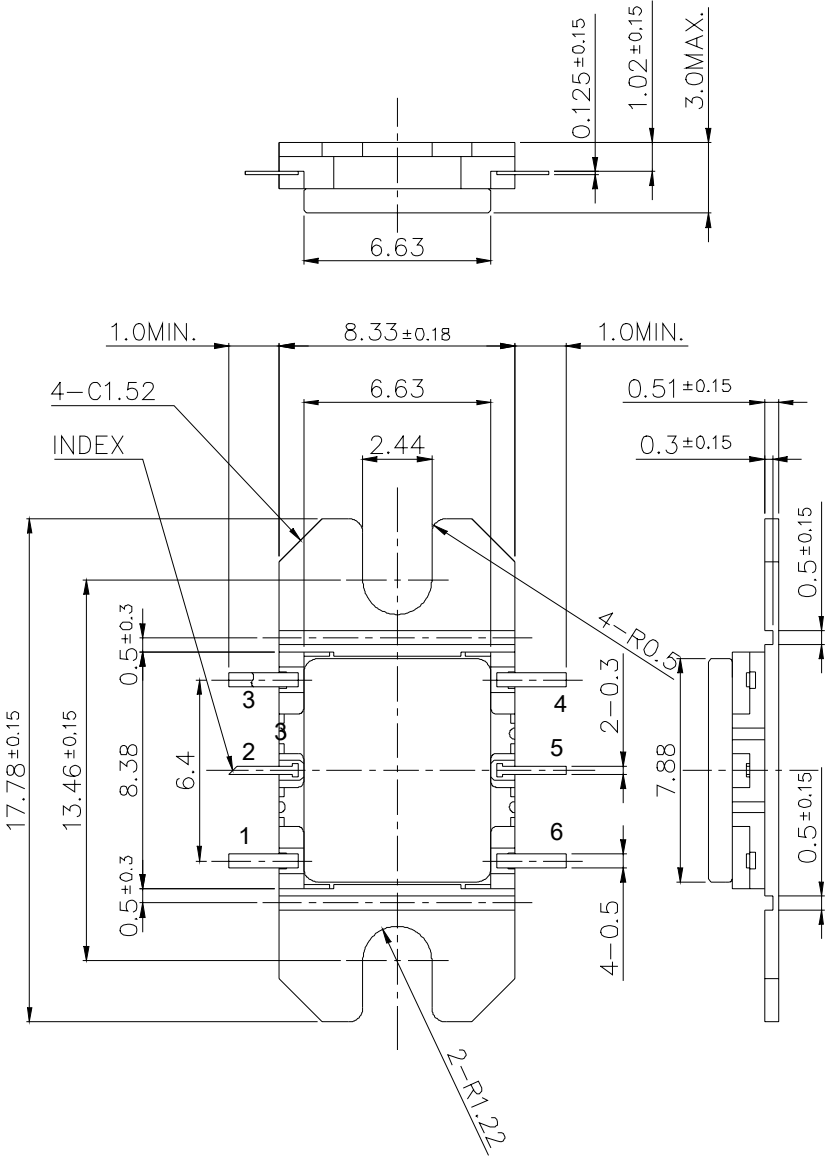

Unit : mm

FMM5056VF

5.8-7.2GHz Power Amplifier MMIC

For further information please contact :

FUJITSU COMPOUND SEMICONDUCTOR, INC.
2355 Zanker Rd.
San Jose, CA 95131-1138, U.S.A.
Phone: (408) 232-9500
FAX: (408) 428-9111
www.fcsi.fujitsu.com

FUJITSU QUANTUM DEVICES EUROPE LTD.
Network House
Norreys Drive
Maidenhead, Berkshire SL6 4FJ
Phone: +44 (0) 1628 504800
FAX: +44 (0) 1628 504888

FUJITSU QUANTUM DEVICES LIMITED
Business Development Division
11th Floor, Hachioji Daiichi-Seimei Bldg.
3-20-6 Myojin-cho
Hachioji-city, Tokyo 192-0046, Japan
TEL: +81-426-43-5885
FAX: +81-426-43-5582

CAUTION
Fujitsu Compound Semiconductor Products contain gallium arsenide (GaAs) which can be hazardous to the human body and the environment. For safety, observe the following procedures:
<ul style="list-style-type: none">• Do not put these products into the mouth.• Do not alter the form of this product into a gas, powder, or liquid through burning, crushing, or chemical processing as these by-products are dangerous to the human body if inhaled, ingested, or swallowed.• Observe government laws and company regulations when discarding this product. This product must be discarded in accordance with methods specified by applicable hazardous waste procedures.

FUJITSU QUANTUM DEVICES SINGAPORE PTE LTD.
Hong Kong Branch
Rm. 1101, Ocean Centre, 5 Canton Rd.
Tsim Sha Tsui, Kowloon, Hong Kong
TEL: +852-23770226
FAX: +852-23763269

Fujitsu Limited reserves the right to change products and specifications without notice.
The information does not convey any license under rights of Fujitsu Limited or others.

© 2003 FUJITSU COMPOUND SEMICONDUCTOR, INC.
Printed in U.S.A. FCSI0202M200