

# Single Channel, AC/DC Sensing Input, Phototransistor Optocoupler In Half-Pitch Mini-Flat 4-Pin Package



MFP4 2.5x4.4, 1.27P  
CASE 100AL

## FODM214, FODM217 Series

The FODM217 series consist of a gallium arsenide infrared emitting diode driving a phototransistor. The FODM214 series consist of two gallium arsenide infrared emitting diodes connected in inverse parallel for AC operation. Both were built in a compact, half-pitch, mini-flat, 4-pin package. The lead pitch is 1.27 mm.

### Features

- Current Transfer Ratio Ranges from 20 to 600%
  - at  $I_F = \pm 1 \text{ mA}$ ,  $V_{CE} = 5 \text{ V}$ ,  $T_A = 25^\circ\text{C}$ 
    - ◆ FODM214 – 20 to 400%
    - ◆ FODM214A – 50 to 250%
  - at  $I_F = 5 \text{ mA}$ ,  $V_{CE} = 5 \text{ V}$ ,  $T_A = 25^\circ\text{C}$ 
    - ◆ FODM217A – 80 to 160%
    - ◆ FODM217B – 130 to 260%
    - ◆ FODM217C – 200 to 400%
    - ◆ FODM217D – 300 to 600%
- Safety and Regulatory Approvals:
  - ◆ UL1577, 3750 VAC<sub>RMS</sub> for 1 min
  - ◆ DIN EN/IEC60747-5-5, 565 V Peak Working Insulation Voltage
- Applicable to Infrared Ray Reflow, 260°C

### Typical Applications

- Primarily Suited for DC-DC Converters
- For Ground Loop Isolation, Signal to Noise Isolation
- Communications – Adapters, Chargers
- Consumer – Appliances, Set Top Boxes
- Industrial – Power Supplies, Motor Control, Programmable Logic Control

### MARKING DIAGRAM

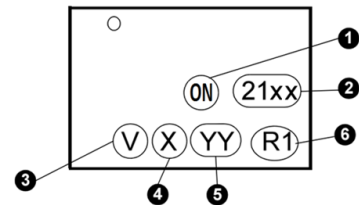

1. ON = Corporate Logo
2. 21xx = Device Number
3. V = DIN EN/IEC60747-5-5 Option
4. X = One-Digit Year Code
5. YY = Digit Work Week
6. R1 = Assembly Package Code

### PIN CONNECTIONS

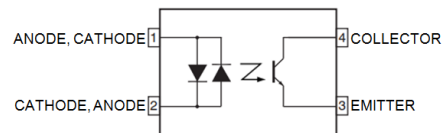

FODM214

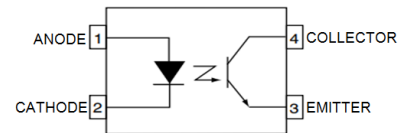

FODM217

### ORDERING INFORMATION

See detailed ordering and shipping information on page 7 of this data sheet.

# FODM214, FODM217 Series

## SAFETY AND INSULATIONS RATING

As per DIN EN/IEC 60747-5-5, this optocoupler is suitable for "safe electrical insulation" only within the safety limit data. Compliance with the safety ratings shall be ensured by means of protective circuits.

Parameter		Characteristics
Installation Classifications per DIN VDE 0110/1.89 Table 1, For Rated Mains Voltage	< 150 V <sub>RMS</sub>	I-IV
	< 300 V <sub>RMS</sub>	I-III
Climatic Classification		55/110/21
Pollution Degree (DIN VDE 0110/1.89)		2
Comparative Tracking Index		175

Symbol	Parameter	Value	Unit
V <sub>PR</sub>	Input-to-Output Test Voltage, Method A, V <sub>IORM</sub> × 1.6 = V <sub>PR</sub> , Type and Sample Test with t <sub>m</sub> = 10 s, Partial Discharge < 5 pC	904	V <sub>peak</sub>
	Input-to-Output Test Voltage, Method B, V <sub>IORM</sub> × 1.875 = V <sub>PR</sub> , 100% Production Test with t <sub>m</sub> = 1 s, Partial Discharge < 5 pC	1060	V <sub>peak</sub>
V <sub>IORM</sub>	Maximum Working Insulation Voltage	565	V <sub>peak</sub>
V <sub>IOTM</sub>	Highest Allowable Over-Voltage	4,000	V <sub>peak</sub>
	External Creepage	≥ 5	mm
	External Clearance	≥ 5	mm
DTI	Distance Through Insulation (Insulation Thickness)	≥ 0.4	mm
T <sub>S</sub>	Case Temperature (Note 1)	150	°C
I <sub>S,INPUT</sub>	Input Current (Note 1)	200	mA
P <sub>S,OUTPUT</sub>	Output Power (Note 1)	300	mW
R <sub>IO</sub>	Insulation Resistance at T <sub>S</sub> , V <sub>IO</sub> = 500 V (Note 1)	> 10 <sup>9</sup>	Ω

1. Safety limit values – maximum values allowed in the event of a failure.

## ABSOLUTE MAXIMUM RATINGS (T<sub>A</sub> = 25°C unless otherwise specified.)

Symbol	Parameter	Value	Units
T <sub>STG</sub>	Storage Temperature	-55 to +150	°C
T <sub>OPR</sub>	Operating Temperature	-55 to +110	°C
T <sub>J</sub>	Junction Temperature	-55 to +125	°C
T <sub>SOL</sub>	Lead Solder Temperature (Refer to Reflow Temperature Profile)	260 for 10 sec	°C

### EMITTER

I <sub>F(average)</sub>	Continuous Forward Current	50	mA
I <sub>F(peak)</sub>	Peak Forward Current (1 μs pulse, 300 pps)	1	A
V <sub>R</sub>	Reverse Input Voltage	6	V
PD <sub>LED</sub>	Power Dissipation (Note 2)	70	mW

### DETECTOR

I <sub>C(average)</sub>	Continuous Collector Current	50	mA
V <sub>CEO</sub>	Collector-Emitter Voltage	80	V
V <sub>ECO</sub>	Emitter-Collector Voltage	7	V
PD <sub>C</sub>	Collector Power Dissipation (Note 2)	150	mW

Stresses exceeding those listed in the Maximum Ratings table may damage the device. If any of these limits are exceeded, device functionality should not be assumed, damage may occur and reliability may be affected.

2. Functional operation under these conditions is not implied. Permanent damage may occur if the device is subjected to conditions outside these ratings.

# FODM214, FODM217 Series

## ELECTRICAL CHARACTERISTICS $T_A = 25^\circ\text{C}$ unless otherwise specified

Symbol	Parameter	Device	Conditions	Min.	Typ.	Max.	Units
<b>EMITTER</b>							
$V_F$	Forward Voltage	FODM214	$I_F = \pm 20 \text{ mA}$		1.2	1.4	V
		FODM217	$I_F = 20 \text{ mA}$				
$I_R$	Reverse Current	FODM217	$V_R = 4 \text{ V}$			10	$\mu\text{A}$
$C_T$	Terminal Capacitance	All	$V = 0 \text{ V}, f = 1 \text{ kHz}$		30	250	pF

## DETECTOR

$BV_{CEO}$	Collector-Emitter Breakdown Voltage	All	$I_C = 0.1 \text{ mA}, I_F = 0 \text{ mA}$	80			V
$BV_{ECO}$	Emitter-Collector Breakdown Voltage	All	$I_E = 10 \mu\text{A}, I_F = 0 \text{ mA}$	7			V
$I_{CEO}$	Collector Dark Current	All	$V_{CE} = 50 \text{ V}, I_F = 0 \text{ mA}$			100	nA

## TRANSFER CHARACTERISTICS $T_A = 25^\circ\text{C}$ unless otherwise specified

Symbol	Parameter	Device	Conditions	Min.	Typ.	Max.	Units
$CTR_{CE}$	Current Transfer Ratio (collector-emitter)	FODM214	$I_F = \pm 1 \text{ mA}, V_{CE} = 5 \text{ V}$	20		400	%
		FODM214A		50		250	
		FODM217A	$I_F = 5 \text{ mA}, V_{CE} = 5 \text{ V}$	80		160	
		FODM217B		130		260	
		FODM217C		200		400	
		FODM217D		300		600	
$I_C$	Collector Current	FODM214	$I_F = \pm 1 \text{ mA}, V_{CE} = 5 \text{ V}$	0.2		2.5	mA
		FODM217	$I_F = 5 \text{ mA}, V_{CE} = 5 \text{ V}$	4		30	
$CTR_{(SAT)}$	Saturated Current Transfer Ratio	FODM214	$I_F = \pm 8 \text{ mA}, V_{CE} = 0.4 \text{ V}$		60		%
		FODM217	$I_F = 8 \text{ mA}, V_{CE} = 0.4 \text{ V}$				
$I_{C(SAT)}$	Collector Current	FODM214	$I_F = \pm 8 \text{ mA}, V_{CE} = 0.4 \text{ V}$		4.8		mA
		FODM217	$I_F = 8 \text{ mA}, V_{CE} = 0.4 \text{ V}$				
$V_{CE(SAT)}$	Collector-Emitter Saturation Voltage	FODM214	$I_F = \pm 8 \text{ mA}, I_C = 2.4 \text{ mA}$			0.4	V
		FODM217	$I_F = 8 \text{ mA}, I_C = 2.4 \text{ mA}$				

## SWITCHING CHARACTERISTICS $T_A = 25^\circ\text{C}$ unless otherwise specified

Symbol	Parameter	Conditions	Min.	Typ.	Max.	Units
$t_{ON}$	Turn On Time	$I_C = 2 \text{ mA}, V_{CE} = 10 \text{ V}, R_L = 100 \Omega$		3		$\mu\text{s}$
$t_{OFF}$	Turn Off Time	$I_C = 2 \text{ mA}, V_{CE} = 10 \text{ V}, R_L = 100 \Omega$		3		$\mu\text{s}$
$t_R$	Output Rise Time (10%–90%)	$I_C = 2 \text{ mA}, V_{CE} = 10 \text{ V}, R_L = 100 \Omega$		3		$\mu\text{s}$
$t_F$	Output Fall Time (90%–10%)	$I_C = 2 \text{ mA}, V_{CE} = 10 \text{ V}, R_L = 100 \Omega$		3		$\mu\text{s}$

## ISOLATION CHARACTERISTICS

Symbol	Parameter	Conditions	Min.	Typ.	Max.	Units
$V_{ISO}$	Input-Output Isolation Voltage	Freq = 60 Hz, $t = 1.0 \text{ min}$ , $I_{I-O} \leq 10 \mu\text{A}$ (Note 3, 4)	3,750			$V_{ACRMS}$
$R_{ISO}$	Isolation Resistance	$V_{I-O} = 500 \text{ V}$ (Note 3)	$5 \times 10^{10}$			$\Omega$
$C_{ISO}$	Isolation Capacitance	Frequency = 1 MHz		0.6	1.0	pF

3. Device is considered a two terminal device: Pin 1 and 2 are shorted together and Pins 3 and 4 are shorted together.

4. 3,750  $V_{ACRMS}$  for 1 minute duration is equivalent to 4,500  $V_{ACRMS}$  for 1 second duration.

# FODM214, FODM217 Series

## TYPICAL CHARACTERISTICS

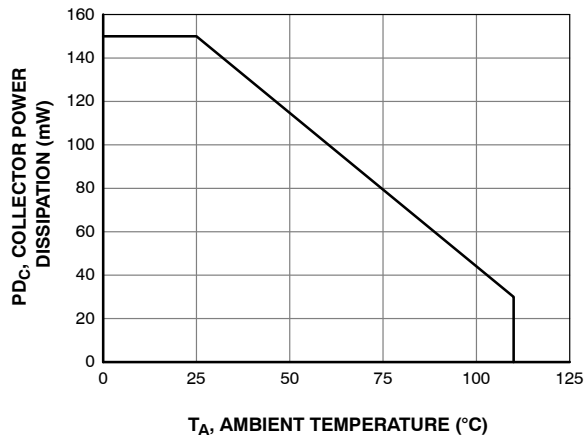

Figure 1. Collector Power Dissipation vs. Ambient Temperature

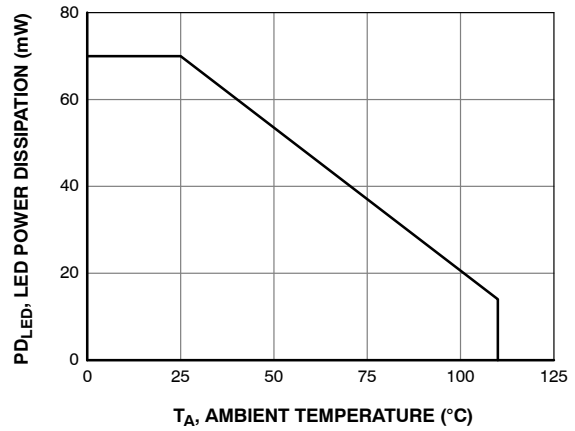

Figure 2. LED Power Dissipation vs. Ambient Temperature

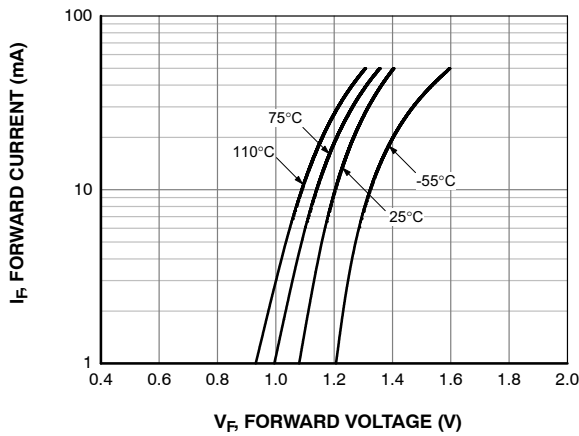

Figure 3. Forward Current vs. Forward Voltage

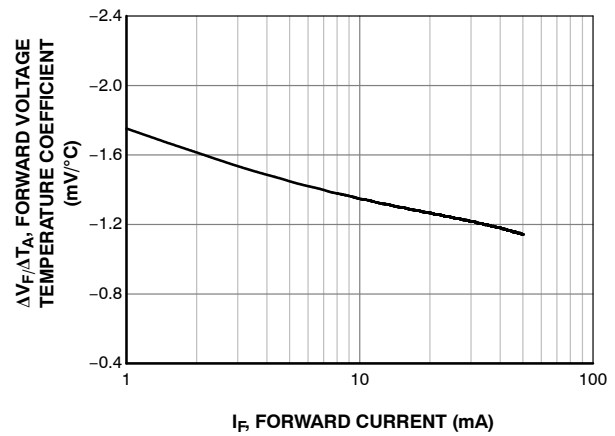

Figure 4. Forward Voltage Temperature Coefficient vs. Forward Current

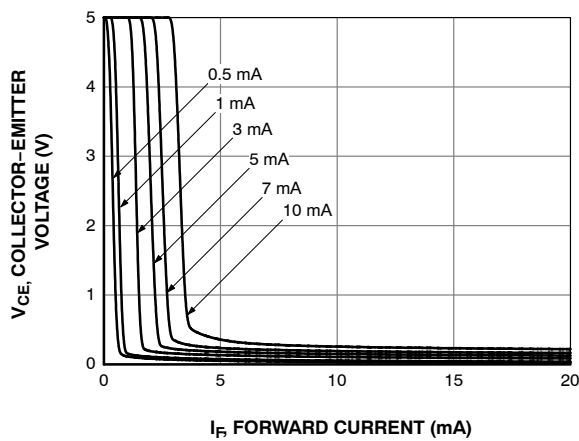

Figure 5. Collector Emitter Voltage vs. Forward Current

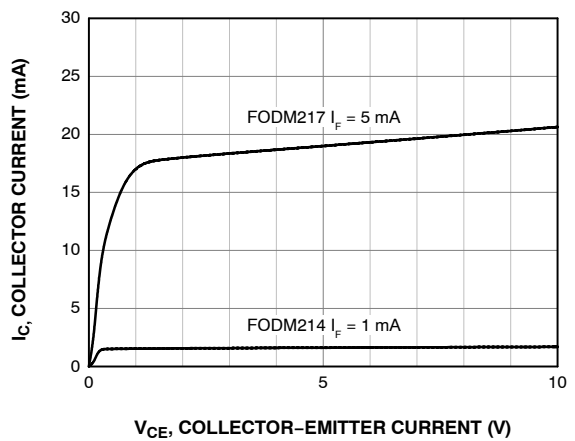
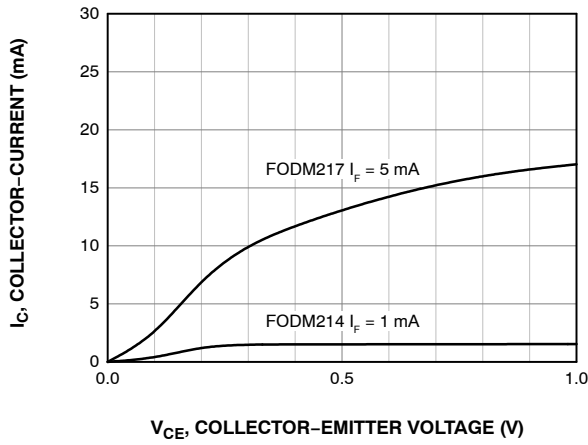
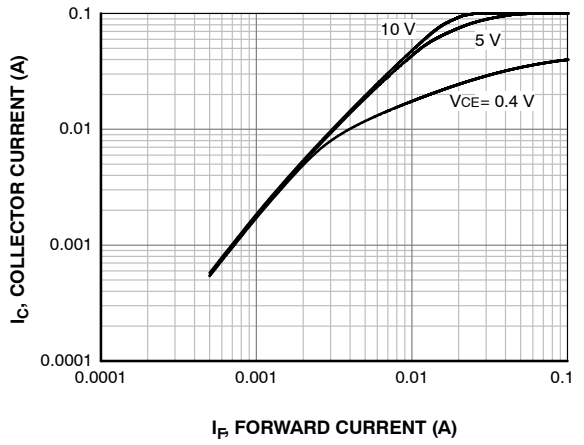

Figure 6. Collector Current vs. Collector-Emitter Voltage

# FODM214, FODM217 Series



**Figure 7. Collector Current vs. Small Collector-Emitter Voltage**



**Figure 8. Collector Current vs. Forward Current**

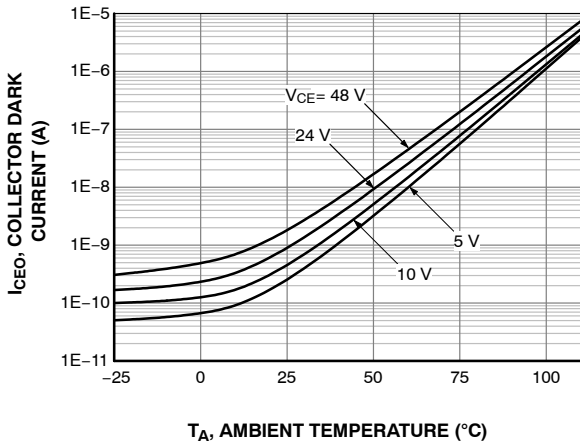

**Figure 9. Collector Dark Current vs. Ambient Temperature**

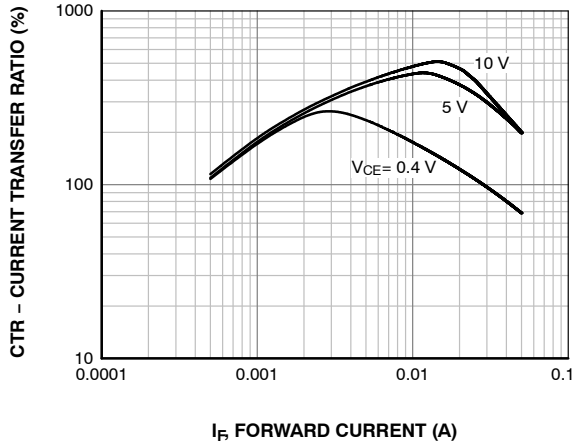

**Figure 10. Current Transfer Ratio vs. Forward Current**

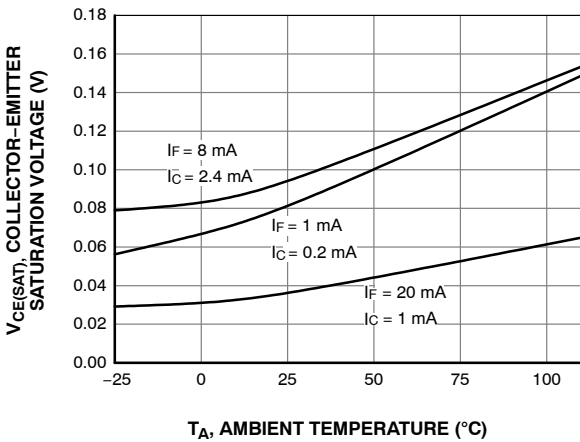

**Figure 11. Collector-Emitter Saturation vs. Ambient Temperature**

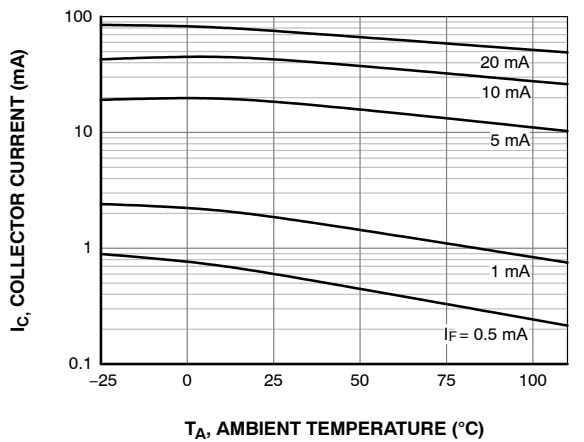

**Figure 12. Collector Current vs. Ambient Temperature**

# FODM214, FODM217 Series

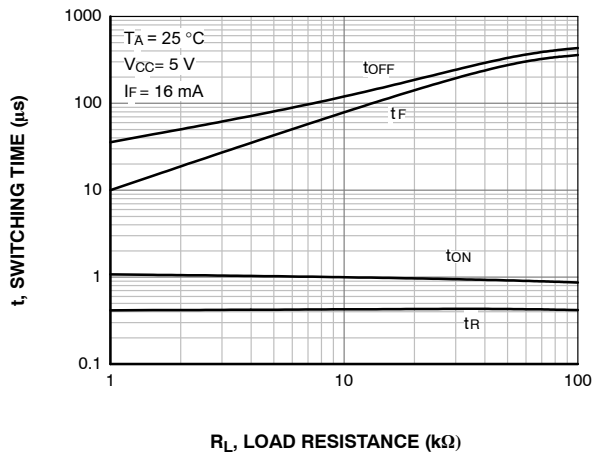

Figure 13. Switching Time vs. Load Resistance

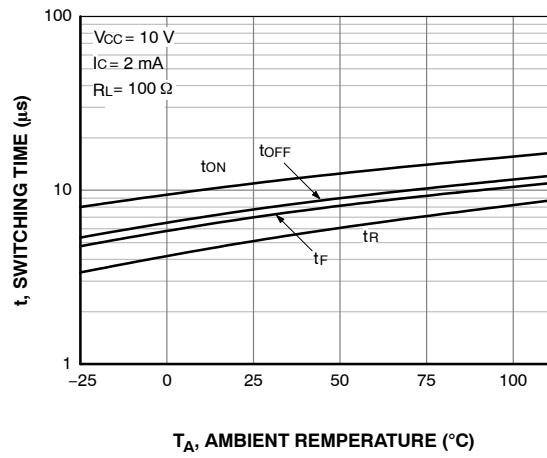

Figure 14. Switching Time vs. Ambient Temperature

## TEST CIRCUIT

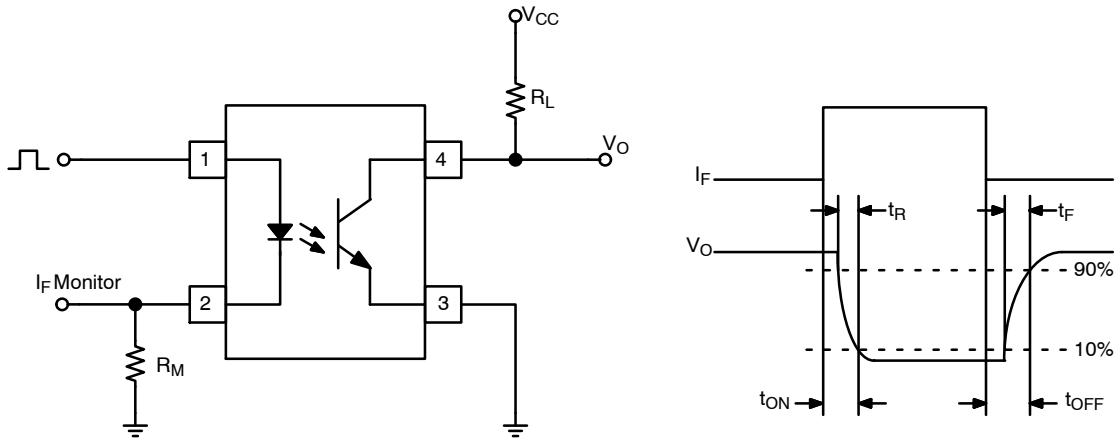

Figure 15. Test Circuit for Switching Time

# FODM214, FODM217 Series

## REFLOW PROFILE

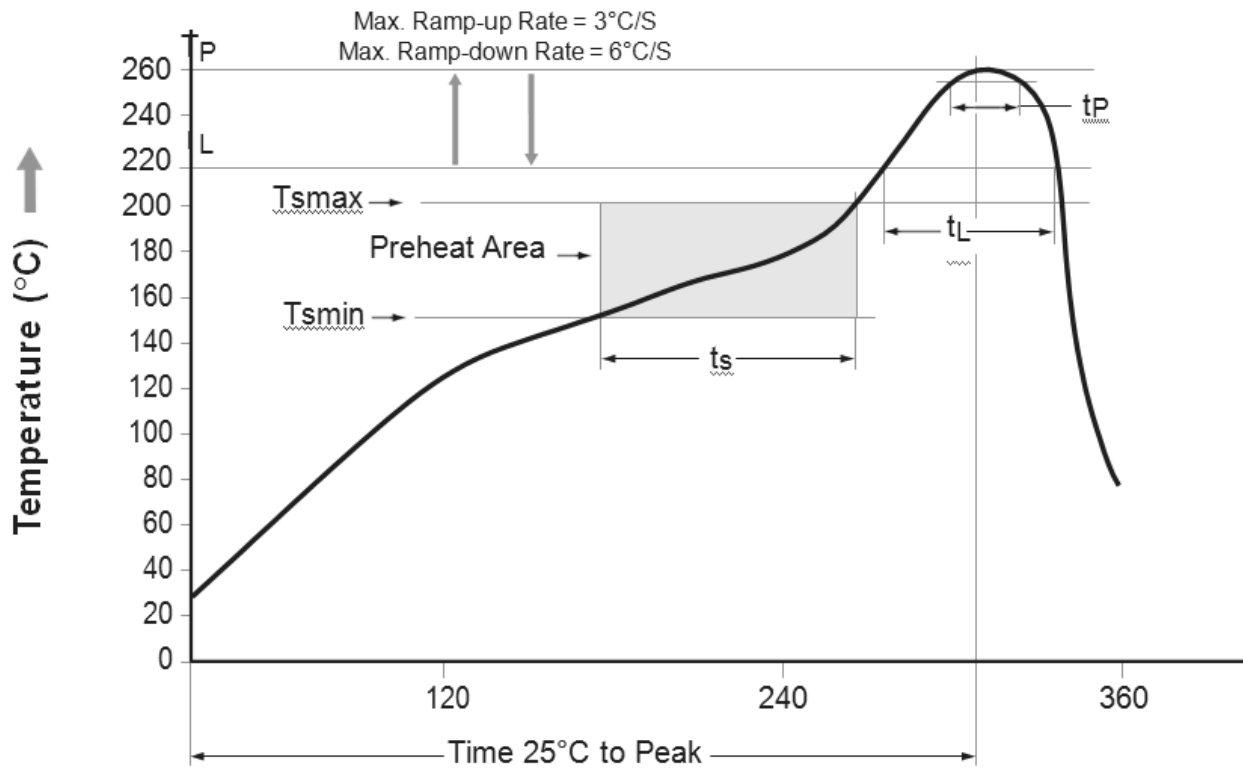

Figure 16. Reflow Profile

Profile Feature	Pb-Free Assembly Profile
Temperature Min. (Tsmmin)	150°C
Temperature Max. (Tsmmax)	200°C
Time (ts) from (Tsmmin to Tsmmax)	60–120 seconds
Ramp-up Rate (tL to tP)	3°C/second max.
Liquidous Temperature (TL)	217°C
Time (tL) Maintained Above (TL)	60–150 seconds
Peak Body Package Temperature	260°C +0°C / -5°C
Time (tP) within 5°C of 260°C	30 seconds
Ramp-down Rate (TP to TL)	6°C/second max.
Time 25°C to Peak Temperature	8 minutes max.

### ORDERING INFORMATION (Note 5)

Part Number	Package	Packing Method
FODM214A	SOP 4-Pin	Tube (100 units)
FODM214AR2	SOP 4-Pin	Tape and Reel (3000 units)
FODM214AV	SOP 4-Pin, DIN EN/IEC60747-5-5 Option	Tube (100 units)
FODM214AR2V	SOP 4-Pin, DIN EN/IEC60747-5-5 Option	Tape and Reel (3000 units)

5. The product orderable part number system listed in this table also applies to the FODM214, FODM217A, FODM217B, FODM217C, and FODM217D products.

# FODM214, FODM217 Series

## PACKAGE DIMENSIONS

MFP4 2.5x4.4, 1.27P  
CASE 100AL  
ISSUE O

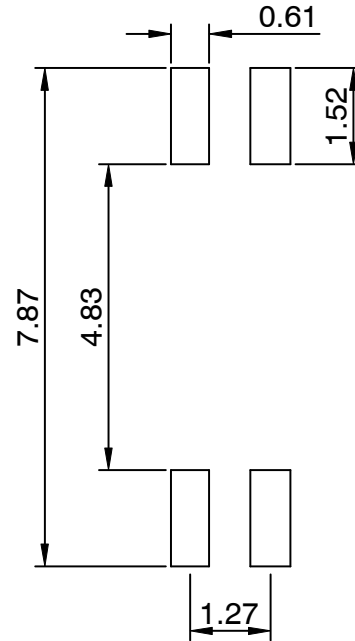
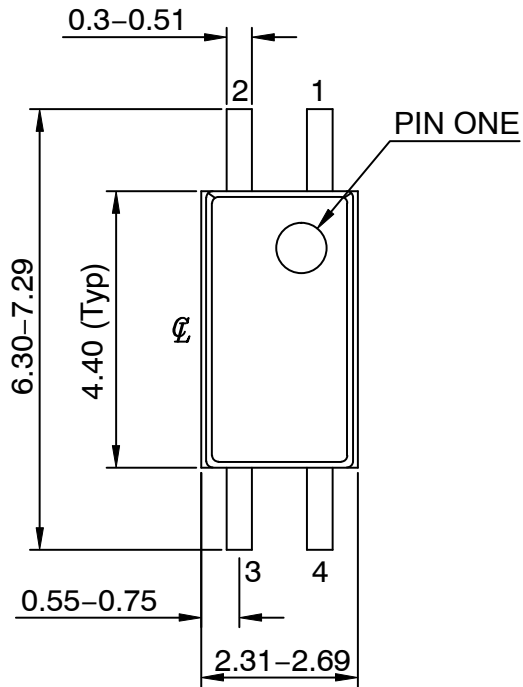

## LAND PATTERN RECOMMENDATION

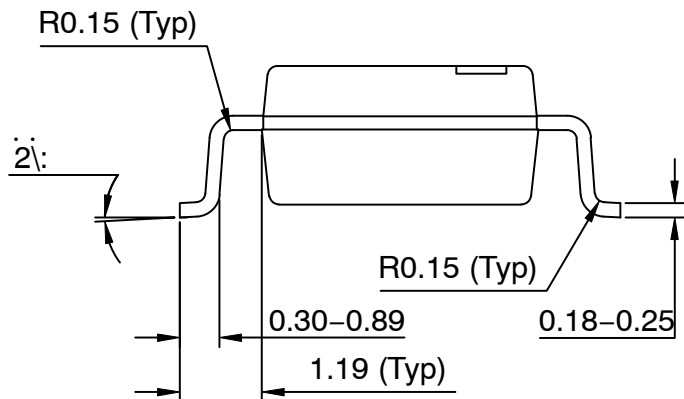
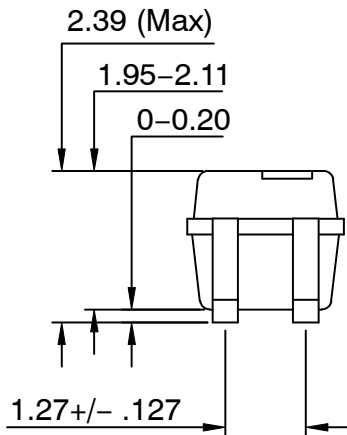

## NOTES:

- A) NO STANDARD APPLIES TO THIS PACKAGE
- B) ALL DIMENSIONS ARE IN MILLIMETERS.
- C) DIMENSIONS ARE EXCLUSIVE OF BURRS, MOLD FLASH, AND TIE BAR EXTRUSION



# FODM214, FODM217 Series

**onsemi**, **Onsemi**, and other names, marks, and brands are registered and/or common law trademarks of Semiconductor Components Industries, LLC dba "**onsemi**" or its affiliates and/or subsidiaries in the United States and/or other countries. **onsemi** owns the rights to a number of patents, trademarks, copyrights, trade secrets, and other intellectual property. A listing of **onsemi**'s product/patent coverage may be accessed at [www.onsemi.com/site/pdf/Patent-Marking.pdf](http://www.onsemi.com/site/pdf/Patent-Marking.pdf). **onsemi** reserves the right to make changes at any time to any products or information herein, without notice. The information herein is provided "as-is" and **onsemi** makes no warranty, representation or guarantee regarding the accuracy of the information, product features, availability, functionality, or suitability of its products for any particular purpose, nor does **onsemi** assume any liability arising out of the application or use of any product or circuit, and specifically disclaims any and all liability, including without limitation special, consequential or incidental damages. Buyer is responsible for its products and applications using **onsemi** products, including compliance with all laws, regulations and safety requirements or standards, regardless of any support or applications information provided by **onsemi**. "Typical" parameters which may be provided in **onsemi** data sheets and/or specifications can and do vary in different applications and actual performance may vary over time. All operating parameters, including "Typicals" must be validated for each customer application by customer's technical experts. **onsemi** does not convey any license under any of its intellectual property rights nor the rights of others. **onsemi** products are not designed, intended, or authorized for use as a critical component in life support systems or any FDA Class 3 medical devices or medical devices with a same or similar classification in a foreign jurisdiction or any devices intended for implantation in the human body. Should Buyer purchase or use **onsemi** products for any such unintended or unauthorized application, Buyer shall indemnify and hold **onsemi** and its officers, employees, subsidiaries, affiliates, and distributors harmless against all claims, costs, damages, and expenses, and reasonable attorney fees arising out of, directly or indirectly, any claim of personal injury or death associated with such unintended or unauthorized use, even if such claim alleges that **onsemi** was negligent regarding the design or manufacture of the part. **onsemi** is an Equal Opportunity/Affirmative Action Employer. This literature is subject to all applicable copyright laws and is not for resale in any manner.

## PUBLICATION ORDERING INFORMATION

### LITERATURE FULFILLMENT:

Email Requests to: [orderlit@onsemi.com](mailto:orderlit@onsemi.com)

**onsemi** Website: [www.onsemi.com](http://www.onsemi.com)

### TECHNICAL SUPPORT

**North American Technical Support:**  
Voice Mail: 1 800-282-9855 Toll Free USA/Canada  
Phone: 011 421 33 790 2910

**Europe, Middle East and Africa Technical Support:**

Phone: 00421 33 790 2910

For additional information, please contact your local Sales Representative