

FPF2140/42/43/44/46/47

Full Function Load Switch with Reverse Current Blocking

Features

- 1.8 to 5.5V Input Voltage Range
- Controlled Turn-On
- 200mA and 400mA Current Limit Options
- Undervoltage Lockout
- Thermal Shutdown
- $2\mu\text{A}$ Shutdown Current
- Auto Restart
- Fast Current limit Response Time
 - 5 μs to Moderate Over Currents
 - 30ns to Hard Shorts
- Fault Blanking
- Reverse Current Blocking
- Power Good Function
- RoHS Compliant

Applications

- PDAs
- Cell Phones
- GPS Devices
- MP3 Players
- Digital Cameras
- Peripheral Ports
- Hot Swap Supplies



General Description

The FPF2140/42/43/44/46/47 is a series of load switches which provides full protection to systems and loads which may encounter large current conditions. These devices contain a 0.12 Ω current-limited P-channel MOSFET which can operate over an input voltage range of 1.8-5.5V. Internally, current is prevented from flowing when the MOSFET is off and the output voltage is higher than the input voltage. Switch control is by a logic input (ON) capable of interfacing directly with low voltage control signals. Each part contains thermal shutdown protection which shuts off the switch to prevent damage to the part when a continuous over-current condition causes excessive heating.

When the switch current reaches the current limit, the part operates in a constant-current mode to prohibit excessive currents from causing damage. For the FPF2140/42/44/46, if the constant current condition still persists after 30ms, the part will shut off the switch and pull the fault signal pin (FLAGB) low. The FPF2140/44 have an auto-restart feature which will turn the switch on again after 450ms if the ON pin is still active. The FPF2142/46 do not have this auto-restart feature so the switch will remain off until the ON pin is cycled. For the FPF2143/47, a current limit condition will immediately pull the fault signal pin low and the part will remain in the constant-current mode until the switch current falls below the current limit. The minimum current limit is 200mA for the FPF2140/42/43 while that for the FPF2144/46/47 is 400mA.

These parts are available in a space-saving 6 pin 2X2 MLP package.

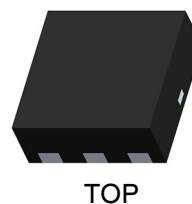
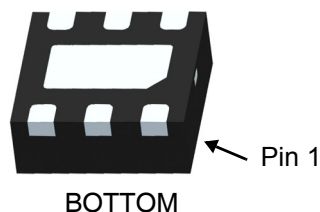

Ordering Information

Part	Current Limit [mA]	Current Limit Blanking Time [ms]	Auto-Restart Time [ms]	ON Pin Activity
FPF2140	200/300/400	15/30/60	225/450/900	Active HI
FPF2142	200/300/400	15/30/60	NA	Active HI
FPF2143	200/300/400	0	NA	Active HI
FPF2144	400/600/800	15/30/60	225/450/900	Active HI
FPF2146	400/600/800	15/30/60	NA	Active HI
FPF2147	400/600/800	0	NA	Active HI

Typical Application Circuit

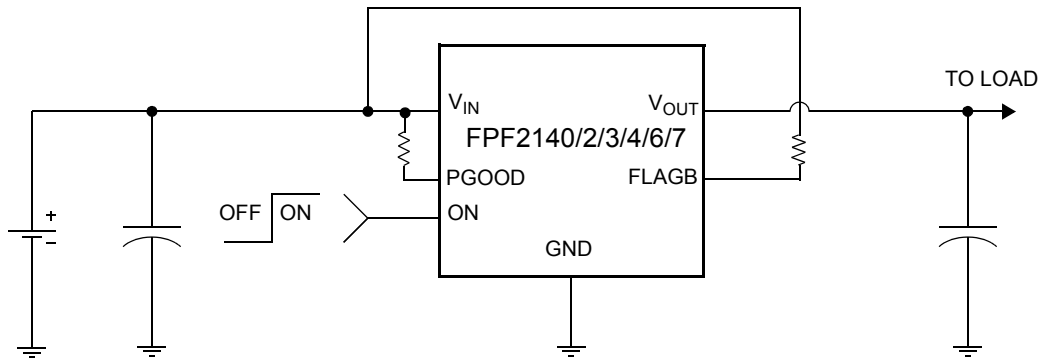

Functional Block Diagram

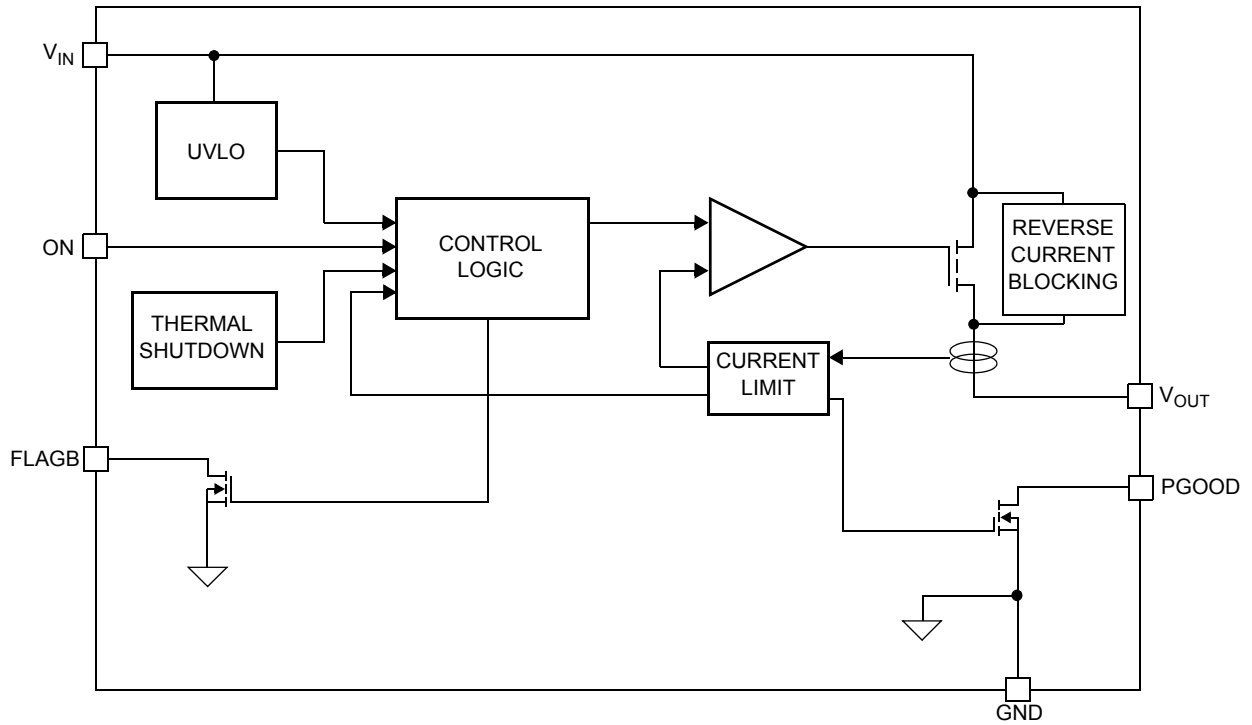

Pin Configuration

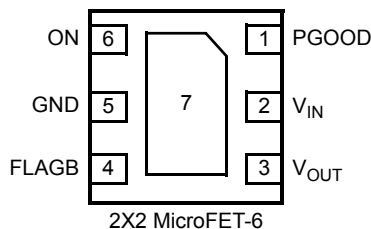

Pin Description

Pin	Name	Function
1	PGOOD	Power Good output: Open drain output which indicate that output voltage has reached 90% of input voltage
2	V_{IN}	Supply Input: Input to the power switch and the supply voltage For the IC
3	V_{OUT}	Switch Output: Output of the power switch
4	FLAGB	Fault Output: Active LO, open drain output which indicates an over current supply under voltage or over temperature state.
5, 7	GND	Ground
6	ON	ON Control Input

Absolute Maximum Ratings

Parameter	Min	Max	Unit
V_{IN} , V_{OUT} , ON, FLAGB, PGOOD to GND	-0.3	6	V
Power Dissipation		1.2	W
Operating and Storage Junction Temperature	-65	150	°C
Thermal Resistance, Junction to Ambient		86	°C/W
Electrostatic Discharge Protection	HBM	4000	V
	MM	400	V

Recommended Operating Range

Parameter	Min	Max	Unit
V_{IN}	1.8	5.5	V
Ambient Operating Temperature, T_A	-40	85	°C

Electrical Characteristics

$V_{IN} = 1.8$ to 5.5 V, $T_A = -40$ to $+85$ °C unless otherwise noted. Typical values are at $V_{IN} = 3.3$ V and $T_A = 25$ °C.

Parameter	Symbol	Conditions	Min	Typ	Max	Units	
Basic Operation							
Operating Voltage	V_{IN}		1.8		5.5	V	
Quiescent Current	I_Q	$I_{OUT} = 0$ mA	$V_{IN} = 1.8$ V	40	70	100	μ A
			$V_{IN} = 3.3$ V		75		
			$V_{IN} = 5.5$ V		85	120	
On-Resistance	R_{ON}	$T_A = 25$ °C, $I_{OUT} = 200$ mA		120	160	m Ω	
		$T_A = 85$ °C, $I_{OUT} = 200$ mA		135			

Electrical Characteristics Cont.

$V_{IN} = 1.8$ to $5.5V$, $T_A = -40$ to $+85^{\circ}C$ unless otherwise noted. Typical values are at $V_{IN} = 3.3V$ and $T_A = 25^{\circ}C$.

Parameter	Symbol	Conditions	Min	Typ	Max	Units	
ON Input Logic High Voltage (ON)	V_{IH}	$V_{IN} = 1.8V$	0.8			V	
		$V_{IN} = 5.5V$	1.4				
ON Input Logic Low Voltage	V_{IL}	$V_{IN} = 1.8V$			0.5	V	
		$V_{IN} = 5.5V$			1		
ON Input Leakage		$V_{ON} = V_{IN}$ or GND	-1		1	μA	
V_{IN} Shutdown Current		$V_{ON} = 0V$, $V_{IN} = 5.5V$, $V_{OUT} =$ short to GND	-2		2	μA	
FLAGB Output Logic Low Voltage		$V_{IN} = 5V$, $I_{SINK} = 10mA$		0.05	0.2	V	
		$V_{IN} = 1.8V$, $I_{SINK} = 10mA$		0.12	0.3		
FLAGB Output High Leakage Current		$V_{IN} = V_{ON} = 5V$			1	μA	
PGOOD Threshold Voltage		$V_{IN} = 5.5V$		90		%	
PGOOD Threshold Voltage Hysteresis				1		%	
PGOOD Output Logic Low Voltage		$V_{IN} = 5V$, $I_{SINK} = 10mA$		0.05	0.1	V	
		$V_{IN} = 1.8V$, $I_{SINK} = 10mA$		0.12	0.2	V	
PGOOD Output High Leakage Current		$V_{IN} = V_{ON} = 5V$			1	μA	
Reverse Block							
V_{OUT} Shutdown Current		$V_{ON} = 0V$, $V_{OUT} = 5.5V$, $V_{IN} =$ short to GND	-2		2	μA	
Protections							
Current Limit	I_{LIM}	$V_{IN} = 3.3V$, $V_{OUT} = 3.0V$	FPF2140, FPF2142, FPF2143	200	300	400	mA
			FPF2144, FPF2146, FPF2147	400	600	800	
Thermal Shutdown		Shutdown Threshold T_J increasing			140		$^{\circ}C$
		Return from Shutdown			130		
		Hysteresis			10		
Under Voltage Lockout	V_{UVLO}	V_{IN} Increasing	1.55	1.65	1.75	V	
Under Voltage Lockout Hysteresis				50		mV	
Dynamic							
Turn on time	t_{DR}	$R_L = 500\Omega$, $C_L = 0.1\mu F$		25		μs	
Turn off time	t_{DF}	$R_L = 500\Omega$, $C_L = 0.1\mu F$		45		μs	
V_{OUT} Rise Time	t_R	$R_L = 500\Omega$, $C_L = 0.1\mu F$		10		μs	
V_{OUT} Fall Time	t_F	$R_L = 500\Omega$, $C_L = 0.1\mu F$		110		μs	
Over Current Blanking Time	t_{BLANK}	FPF2140, FPF2142, FPF2144, FPF2146	15	30	60	ms	
Auto-Restart Time	t_{RSTRT}	FPF2140, FPF2144	225	450	900	ms	
Short Circuit Response Time		$V_{IN} = V_{ON} = 3.3V$. Moderate Over-Current Condition		5		μs	
		$V_{IN} = V_{ON} = 3.3V$. Hard Short		30		ns	

Note 1: Package power dissipation on 1 square inch pad, 2 oz. copper board.

Typical Characteristics

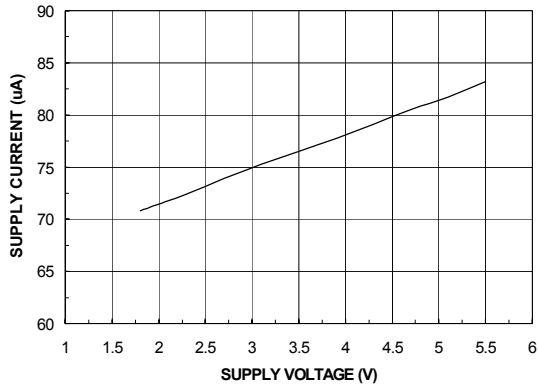

Figure 1. Quiescent Current vs. Input Voltage

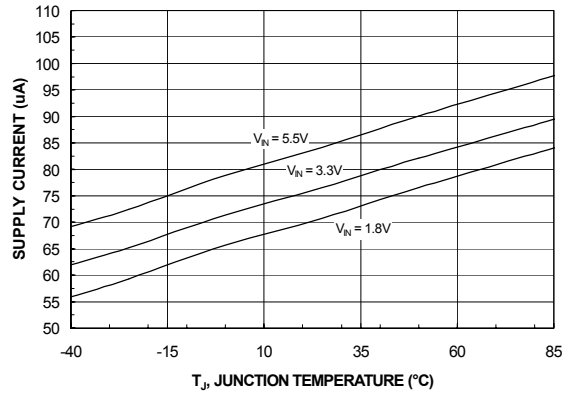

Figure 2. Quiescent Current vs. Temperature

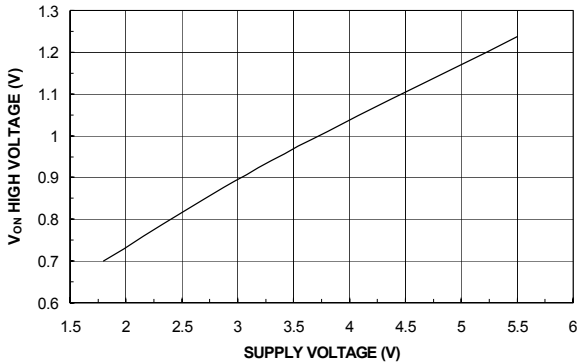

Figure 3. V_{ON} High Voltage vs. Input Voltage

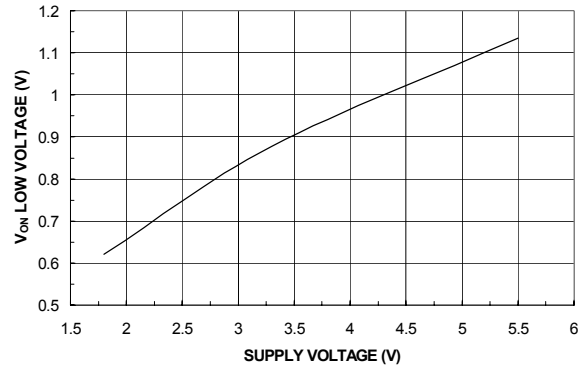

Figure 4. V_{ON} Low Voltage vs. Input Voltage

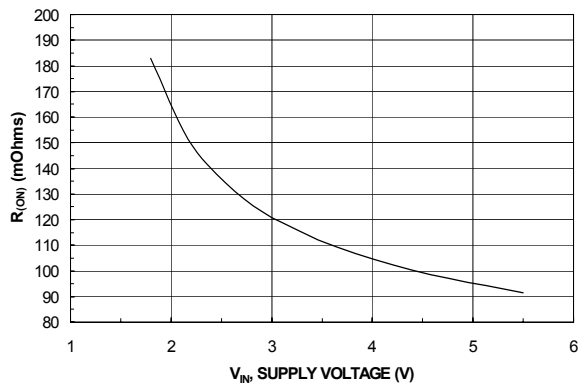

Figure 5. R_(ON) vs. V_{IN}

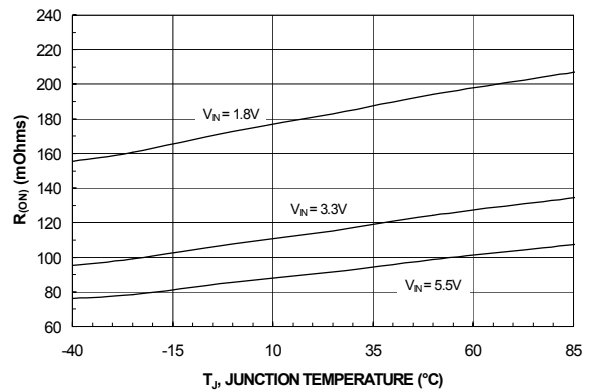

Figure 6. R_(ON) vs. Temperature

Typical Characteristics

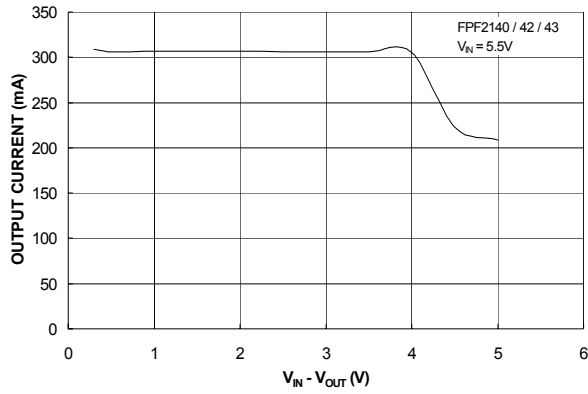

Figure 7. Current Limit vs. Output Voltage

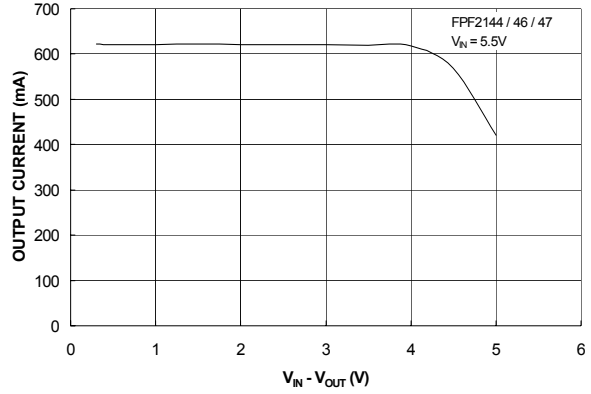

Figure 8. Current

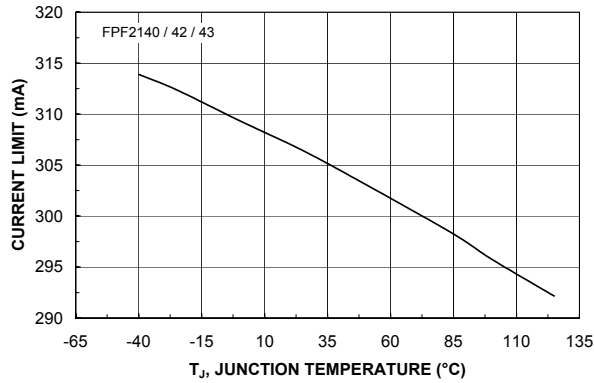

Figure 9. Current Limit vs. Temperature

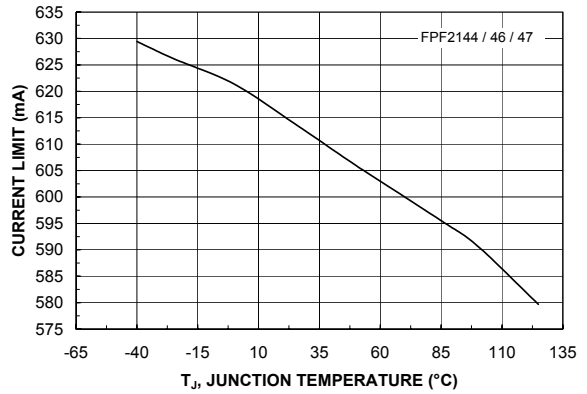

Figure 10. Current Limit vs. Temperature

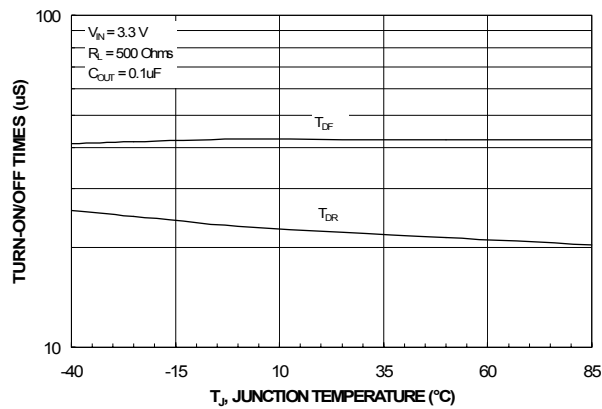

Figure 11. T_{DR} / T_{DF} vs. Temperature

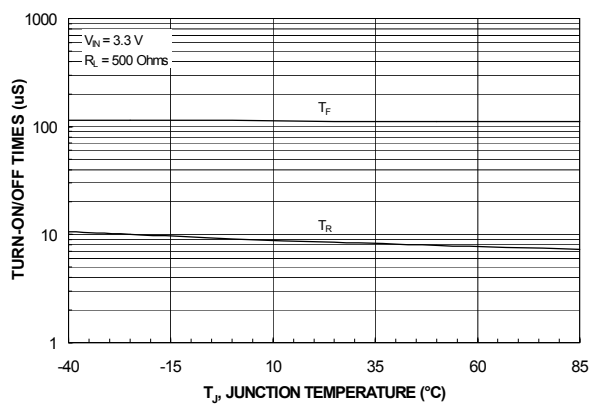

Figure 12. T_{RISE} / T_{FALL} vs. Temperature

Typical Characteristics

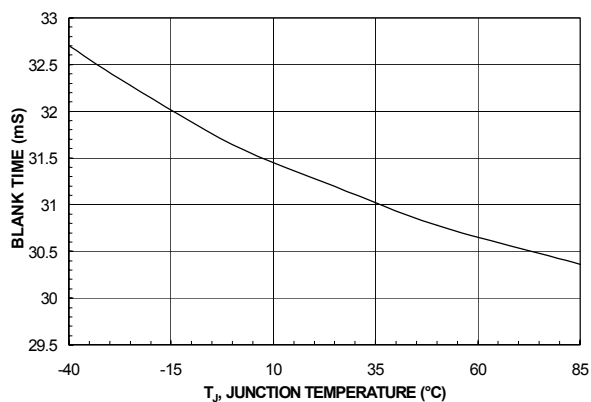

Figure 13. T_{BLANK} vs. Temperature

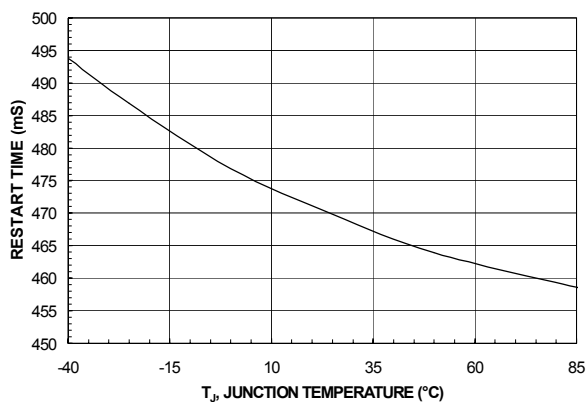

Figure 14. T_{RESTART} vs. Temperature

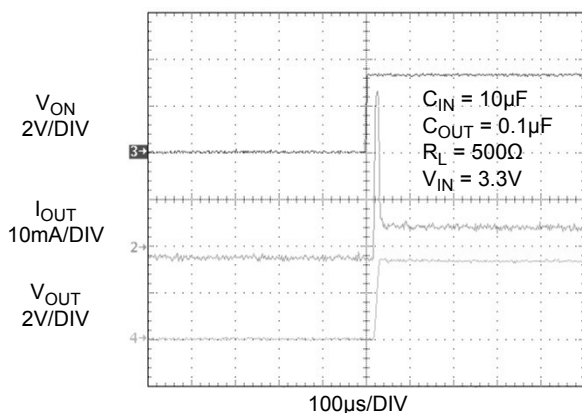

Figure 15. T_{DR} Response

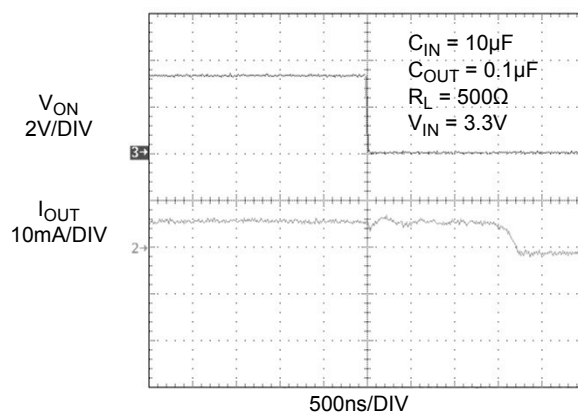

Figure 16. T_{DF} Response

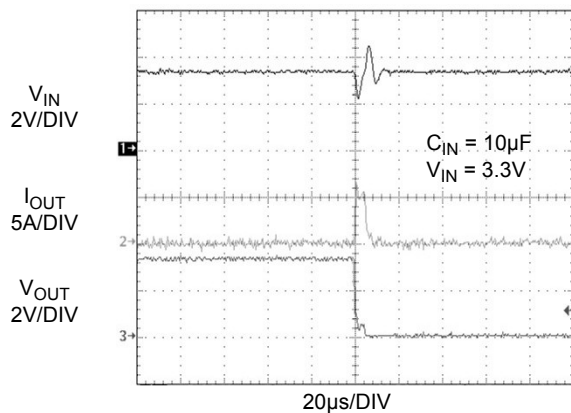

Figure 17. Short Circuit Response Time (Output shorted to GND)

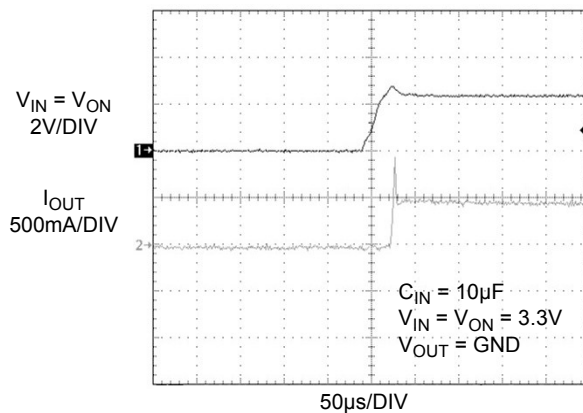

Figure 18. Current Limit Response Time (Switch is powered into a short)

Typical Characteristics

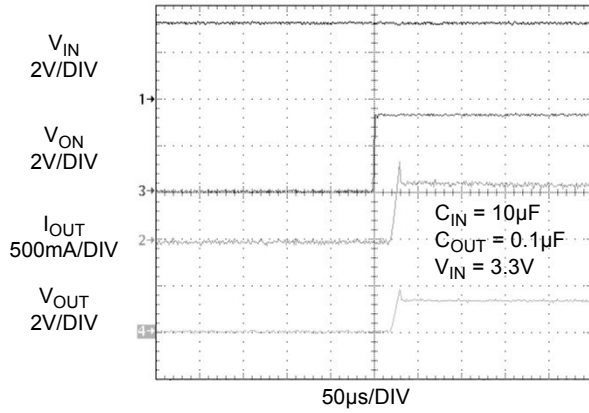

Figure 19. Current Limit Response Time (Output is loaded by 2.2Ω, $C_{OUT} = 0.1\mu F$)

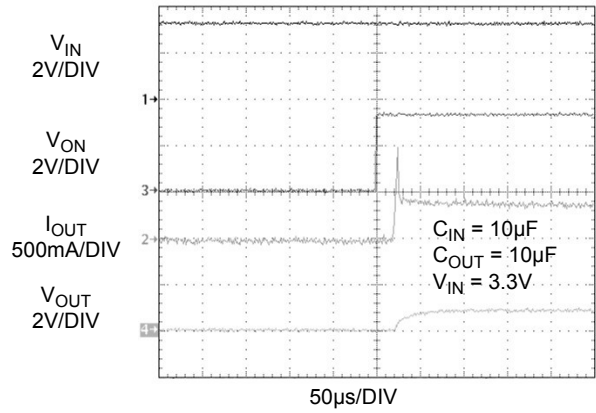

Figure 20. Current Limit Response Time (Output is loaded by 2.2Ω, $C_{OUT} = 10\mu F$)

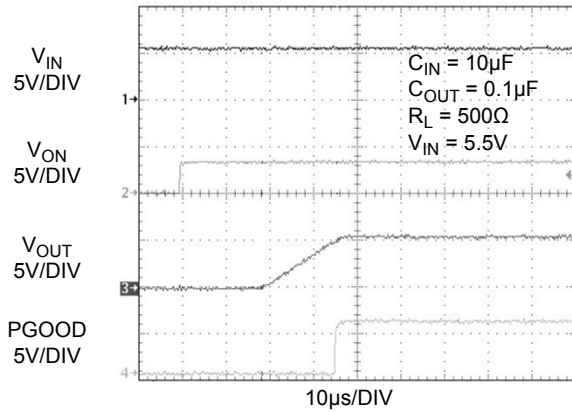

Figure 21. PGOOD Response

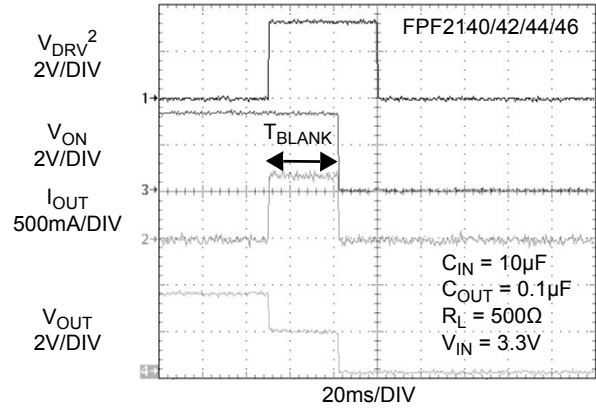

Figure 22. T_{BLANK} Response

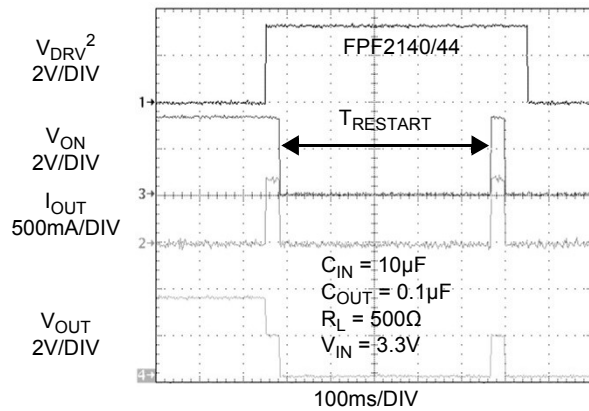

Figure 23. $T_{RESTART}$ Response

Note 2: V_{DRV} signal forces the device to go into overcurrent condition by loading.

Description of Operation

The FPF2140/42/43/44/46/47 are current limited switches that protect systems and loads which can be damaged or disrupted by the application of high currents. The core of each device is a 0.12Ω P-channel MOSFET and a controller capable of functioning over a wide input operating range of 1.8-5.5V. The controller protects against system malfunctions through current limiting, undervoltage lockout and thermal shutdown. The current limit is preset for either 200mA or 400mA.

On/Off Control

The ON pin controls the state of the switch. Activating ON continuously holds the switch in the on state so long as there is no undervoltage on V_{IN} or a junction temperature in excess of 140°C. ON is active HI and has a low threshold making it capable of interfacing with low voltage signals. In addition, excessive currents will cause the switch to turn off for FPF2140/42 and FPF2144/46. The FPF2140/44 have an Auto-Restart feature which will automatically turn the switch on again after 450ms. For the FPF2142/46, the ON pin must be toggled to turn-on the switch again. With no auto-restart, the FPF2143/47 do not turn off in response to a over current condition but instead remain operating in a constant current mode so long as ON is active and the thermal shutdown or undervoltage lockout have not activated.

Fault Reporting

Upon the detection of an over-current, an input undervoltage, or an over-temperature condition, the FLAGB signals the fault mode by activating LO. For the FPF2140/42/44/46, the FLAGB goes LO at the end of the blanking time while FLAGB goes LO immediately for the FPF2143/47. FLAGB remains LO through the Auto-Restart Time for the FPF2140/44. For the FPF2142/46, FLAGB is latched LO and ON must be toggled to release it. With the FPF2143/47, FLAGB is LO during the faults and immediately returns HI at the end of the fault condition. FLAGB is an open-drain MOSFET which requires a pull-up resistor between V_{IN} and FLAGB. During shutdown, the pull-down on FLAGB is disabled to reduce current draw from the supply.

Current Limiting

The current limit guarantees that the current through the switch doesn't exceed a maximum value while not limiting at less than a minimum value. For the FPF2140/42/43 the minimum current is 200mA and the maximum current is 400mA and for the FPF2144/46/47 the minimum current is 400mA and the maximum current is 800mA. The FPF2140/42/44/46 have a blanking time of 30ms, nominally, during which the switch will act as a constant current source. At the end of the blanking time, the switch will be turned-off and the FLAGB pin will activate to indicate that current limiting has occurred. The FPF2143/47 have no current limit blanking period so immediately upon a current limit condition FLAGB is activated. These parts will remain in a constant current state until the ON pin is deactivated or the thermal shutdown turns-off the switch.

For preventing the switch from large power dissipation during heavy load a short circuit detection feature is introduced. Short circuit condition is detected by observing the output voltage. The switch is put into short circuit current limiting mode if the switch is loaded with a heavy load. When the output voltage drops below VSCTH, short circuit detection threshold voltage, the current limit value re-conditioned and short circuit current limit value is decreased to 62.5% of the current limit value. This keeps the power dissipation of the part below a certain limit even at dead short conditions at 5.5V input voltage. The VSCTH value is set to be 1V. At around 1.1V of output voltage the switch is removed from short circuit current limiting mode and the current limit is set to the current limit value.

Undervoltage Lockout

The undervoltage lockout turns-off the switch if the input voltage drops below the undervoltage lockout threshold. With the ON pin active the input voltage rising above the undervoltage lockout threshold will cause a controlled turn-on of the switch which limits current over-shoots.

Reverse Current Blocking

The entire FPF2140/47 family has a Reverse Current Blocking feature that protects input source against current flow from output to input. For a standard USB power design, this is an important feature which protects the USB host from being damaged due to reverse current flow on V_{BUS} . The reverse current blocking feature is active when the load switch is turned off.

If ON pin is LO and output voltage become greater than input voltage, no current can flow from the output to the input. The FLAGB operation is independent of the Reverse Current blocking feature and will not report a fault condition if this feature is activated.

Thermal Shutdown

The thermal shutdown protects the die from internally or externally generated excessive temperatures. During an over-temperature condition the FLAGB is activated and the switch is turned-off. The switch automatically turns-on again if temperature of the die drops below the threshold temperature.

Application Information

Typical Application

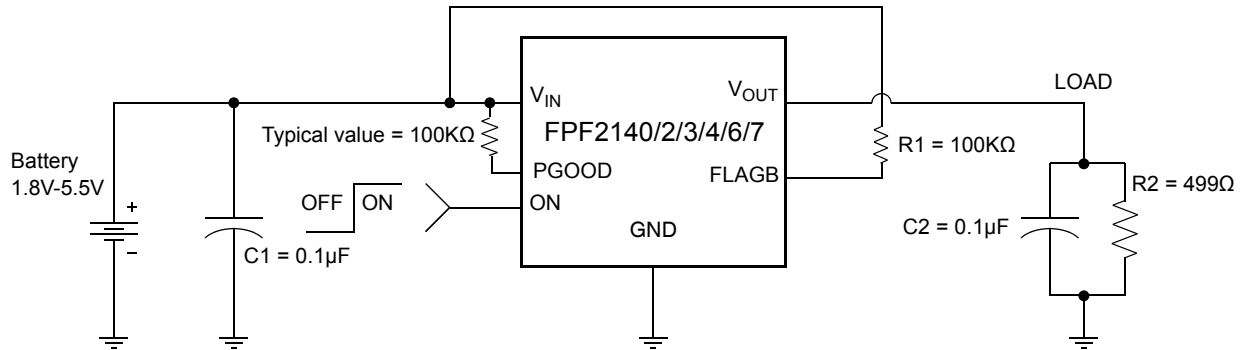

Input Capacitor

To limit the voltage drop on the input supply caused by transient in-rush currents when the switch turns-on into a discharged load capacitor or a short-circuit, a capacitor needs to be placed between V_{IN} and GND. A $0.1\mu\text{F}$ ceramic capacitor, C_{IN} , placed close to the pins is usually sufficient. Higher values of C_{IN} can be used to further reduce the voltage drop.

Output Capacitor

A $0.1\mu\text{F}$ capacitor C_{OUT} , should be placed between V_{OUT} and GND. This capacitor will prevent parasitic board inductances from forcing V_{OUT} below GND when the switch turns-off. For the FPF2140/42/44/46, the total output capacitance needs to be kept below a maximum value, $C_{OUT(max)}$, to prevent the part from registering an over-current condition and turning-off the switch. The maximum output capacitance can be determined from the following formula,

$$C_{OUT(max)} = \frac{I_{LIM(max)} \times t_{BLANK(min)}}{V_{IN}} \quad (1)$$

Power Dissipation

During normal operation as a switch, the power dissipation is small and has little effect on the operating temperature of the part. The parts with the higher current limits will dissipate the most power and that will only be,

$$P = (I_{LIM})^2 \times R_{DS} = (0.8)^2 \times 0.12 = 76.8\text{mW} \quad (2)$$

If the part goes into current limit the maximum power dissipation will occur when the output is shorted to ground. For the FPF2140/44, the power dissipation will scale by the Auto-Restart Time, t_{RSTRT} , and the Over Current Blanking Time, t_{BLANK} , so that the maximum power dissipated is,

$$P(max) = \frac{t_{BLANK}}{t_{BLANK} + t_{RSTRT}} \times V_{IN(max)} \times I_{LIM(max)}$$

$$= \frac{30}{30 + 450} \times 5.5 \times 0.8 = 275\text{mW} \quad (3)$$

When using the FPF2142/46 attention must be given to the manual resetting of the part. The junction temperature will only be allowed to increase to the thermal shutdown threshold. Once this temperature has been reached, toggling ON will not turn-on the switch until the junction temperature drops. For the FPF2140/44, a short on the output will cause the part to operate in a constant current state dissipating a worst case power as calculated in (3) until the thermal shutdown activates. It will then cycle in and out of thermal shutdown so long as the ON pin is active and the short is present.

Board Layout

For best performance, all traces should be as short as possible. To be most effective, the input and output capacitors should be placed close to the device to minimize the effects that parasitic trace inductances may have on normal and short-circuit operation. Using wide traces for V_{IN} , V_{OUT} and GND will help minimize parasitic electrical effects along with minimizing the case to ambient thermal impedance.

The middle pad (pin 7) should be connected to the GND plate of PCB for improving thermal performance of the load switch. An improper layout could result higher junction temperature and triggering the thermal shutdown protection feature. This concern applies specially with FPF2143 and FPF2147 where load switch turns on into an overcurrent condition and switch supplies constant current limit value. In this case power dissipation of the switch ($P_D = (V_{IN} - V_{OUT}) \times I_{LIM(max)}$) could exceed the maximum absolute power dissipation of 1.2W.

Application Notes

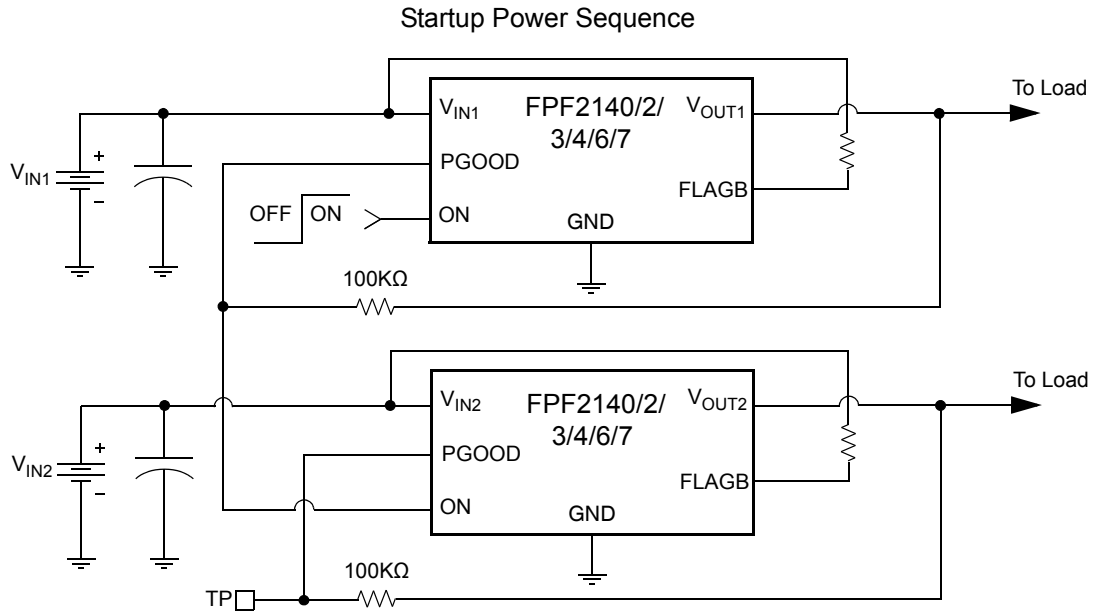

Power good function in sequential startup. No battery is loaded to the output

Power Good

FPF214X family has a "Power Good" feature. PGOOD pin is an open-drain MOSFET which asserts high when the output voltage reaches 90% of the input voltage.

PGOOD pin requires an external pull up resistor that is connected to the output voltage when there is no battery in the load side and the logic level of the subsequent controller permits. This would give logic levels similar to a CMOS output stage for PGOOD, while still keeping the option to tie the pull-up to a different supply voltage. A typical value of 100KΩ is recommended to be used as pull up resistor. The PGOOD pin status is independent of the ON pin position. This means that PGOOD pin stays low when the load switch is OFF. If the Power Good feature is not used in the application the pin can be connected directly to GND.

Sequential Startup using Power Good

The power good pin can be connected to another load switch's enable pin to implement sequential startup. PGOOD pin asserts low when the load switch is OFF. This feature allows driving a subsequent circuit. The above diagram illustrates power good function in sequential startup. As the V_{OUT1} of the first load switch starts to ramp to the 90% of its input voltage the second switch remains in OFF state. Whereas the V_{OUT1} passes the 90% threshold, power good signal becomes active and asserts high. This signal will turn on the second load switch and V_{OUT2} will start to increase. The total startup time may vary according to the difference between supply voltages that are used in the application.

Dimensional Outline and Pad Layout

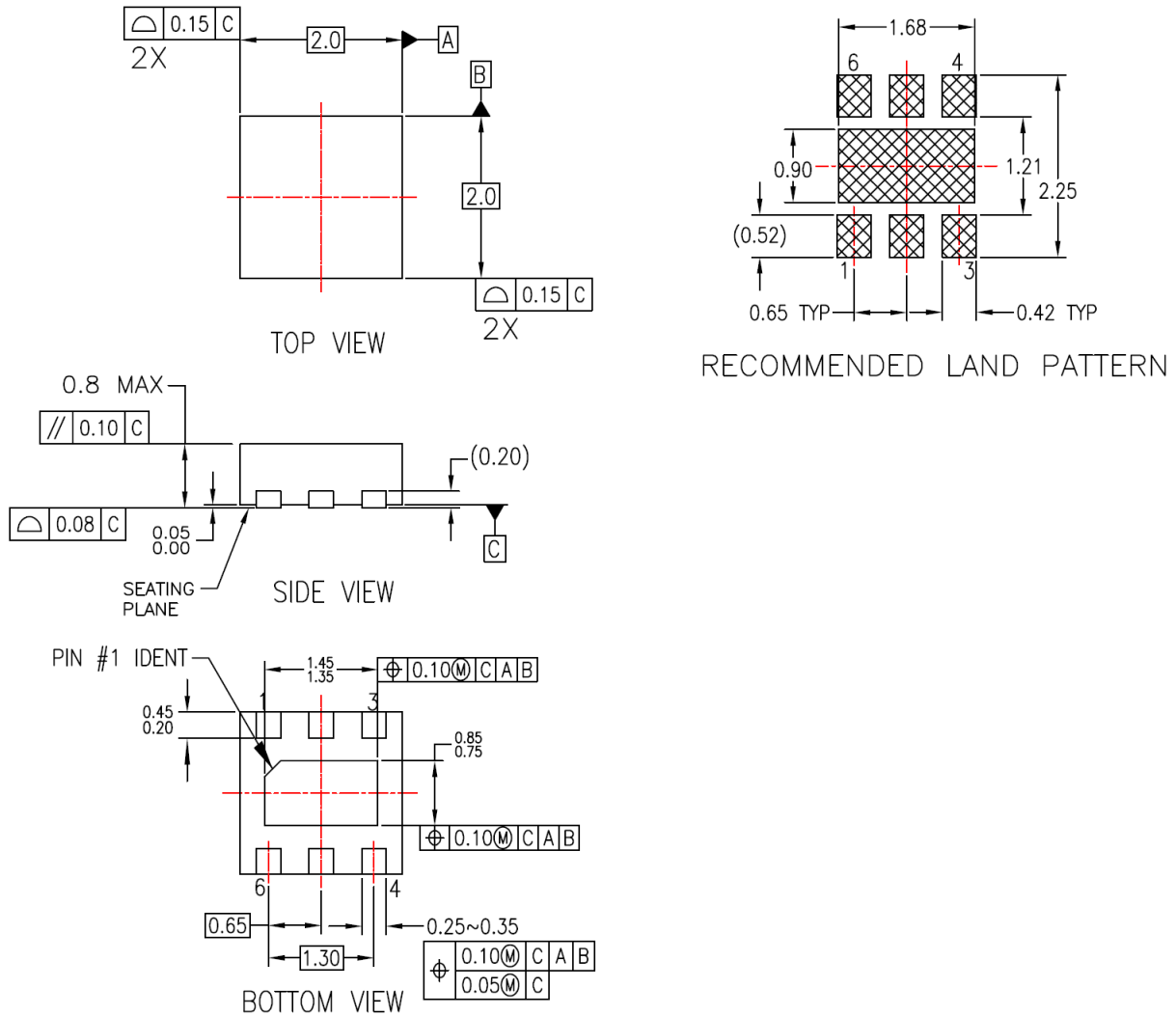

NOTES:

- A. NON-CONFORMS TO JEDEC REGISTRATION,
- B. DIMENSIONS ARE IN MILLIMETERS.
- C. DIMENSIONS AND TOLERANCES PER ASME Y14.5M, 1994

MLP06KrevA



TRADEMARKS

The following are registered and unregistered trademarks and service marks Fairchild Semiconductor owns or is authorized to use and is not intended to be an exhaustive list of all such trademarks.

- | | | | |
|--------------------------|---|----------------------------|----------------------------|
| ACEx® | Green FPS™ | Power247® | SuperSOT™-8 |
| Build it Now™ | Green FPS™ e-Series™ | POWEREDGE® | SyncFET™ |
| CorePLUS™ | GTO™ | Power-SPM™ | The Power Franchise® |
| CROSSVOLT™ | <i>i-Lo</i> ™ | PowerTrench® | the power franchise |
| CTL™ | IntelliMAX™ | Programmable Active Droop™ | TinyBoost™ |
| Current Transfer Logic™ | ISOPLANAR™ | QFET® | TinyBuck™ |
| EcoSPARK® | MegaBuck™ | QS™ | TinyLogic® |
| F ® | MICROCOUPLER™ | QT Optoelectronics™ | TINYOPTO™ |
| Fairchild® | MicroFET™ | Quiet Series™ | TinyPower™ |
| Fairchild Semiconductor® | MicroPak™ | RapidConfigure™ | TinyPWM™ |
| FACT Quiet Series™ | MillerDrive™ | SMART START™ | TinyWire™ |
| FACT® | Motion-SPM™ | SPM® | µSerDes™ |
| FAST® | OPTOLOGIC® | STEALTH™ | UHC® |
| FastvCore™ | OPTOPLANAR® | SuperFET™ | UniFET™ |
| FPS™ |  ® | SuperSOT™-3 | VCX™ |
| FRFET® | PDP-SPM™ | SuperSOT™-6 | |
| Global Power ResourceSM | Power220® | | |

DISCLAIMER

FAIRCHILD SEMICONDUCTOR RESERVES THE RIGHT TO MAKE CHANGES WITHOUT FURTHER NOTICE TO ANY PRODUCTS HEREIN TO IMPROVE RELIABILITY, FUNCTION, OR DESIGN. FAIRCHILD DOES NOT ASSUME ANY LIABILITY ARISING OUT OF THE APPLICATION OR USE OF ANY PRODUCT OR CIRCUIT DESCRIBED HEREIN; NEITHER DOES IT CONVEY ANY LICENSE UNDER ITS PATENT RIGHTS, NOR THE RIGHTS OF OTHERS. THESE SPECIFICATIONS DO NOT EXPAND THE TERMS OF FAIRCHILD'S WORLDWIDE TERMS AND CONDITIONS, SPECIFICALLY THE WARRANTY THEREIN, WHICH COVERS THESE PRODUCTS.

LIFE SUPPORT POLICY

FAIRCHILD'S PRODUCTS ARE NOT AUTHORIZED FOR USE AS CRITICAL COMPONENTS IN LIFE SUPPORT DEVICES OR SYSTEMS WITHOUT THE EXPRESS WRITTEN APPROVAL OF FAIRCHILD SEMICONDUCTOR CORPORATION.

As used herein:

- Life support devices or systems are devices or systems which, (a) are intended for surgical implant into the body, or (b) support or sustain life, and (c) whose failure to perform when properly used in accordance with instructions for use provided in the labeling, can be reasonably expected to result in significant injury to the user.
- A critical component is any component of a life support device or system whose failure to perform can be reasonably expected to cause the failure of the life support device or system, or to affect its safety or effectiveness.

PRODUCT STATUS DEFINITIONS

Definition of Terms

Datasheet Identification	Product Status	Definition
Advance Information	Formative or In Design	This datasheet contains the design specifications for product development. Specifications may change in any manner without notice.
Preliminary	First Production	This datasheet contains preliminary data; supplementary data will be published at a later date. Fairchild Semiconductor reserves the right to make changes at any time without notice to improve design.
No Identification Needed	Full Production	This datasheet contains final specifications. Fairchild Semiconductor reserves the right to make changes at any time without notice to improve design.
Obsolete	Not In Production	This datasheet contains specifications on a product that has been discontinued by Fairchild semiconductor. The datasheet is printed for reference information only.