

Pb Free Plating Product

FQP65N06



65A,60V Heatsink Planar N-Channel Power MOSFET

Features

- 65A, 60V, $R_{DS(on)} = 0.016\Omega$ @ $V_{GS} = 10V$
- Low gate charge (typical 48 nC)
- Low Crss (typical 100 pF)
- Fast switching
- 100% avalanche tested
- Improved dv/dt capability
- 175°C maximum junction temperature rating

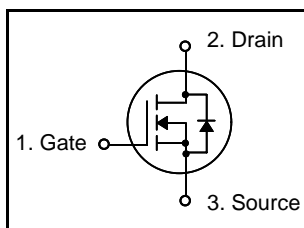

$BV_{DSS} = 60V$
 $R_{DS(ON)} = 0.016\text{ ohm}$
 $I_D = 65A$

General Description

This N-channel enhancement mode field-effect power transistor using THINKI Semiconductor advanced planar stripe, DMOS technology intended for off-line switch mode power supply.

Also, especially designed to minimize $r_{ds(on)}$ and high rugged avalanche characteristics. The TO-220M pkg is well suited for adaptor power unit and small power inverter application.

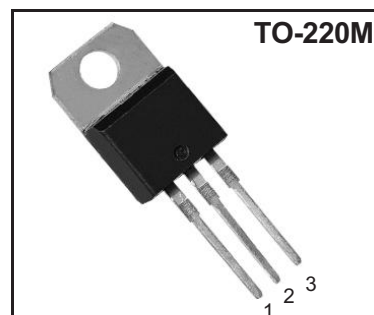

Absolute Maximum Ratings $T_C = 25^\circ C$ unless otherwise noted

Symbol	Parameter	FQP65N06	Units
V_{DSS}	Drain-Source Voltage	60	V
I_D	Drain Current - Continuous ($T_C = 25^\circ C$) - Continuous ($T_C = 100^\circ C$)	65	A
		46.1	A
I_{DM}	Drain Current - Pulsed (Note 1)	260	A
V_{GSS}	Gate-Source Voltage	± 25	V
E_{AS}	Single Pulsed Avalanche Energy (Note 2)	650	mJ
I_{AR}	Avalanche Current (Note 1)	65	A
E_{AR}	Repetitive Avalanche Energy (Note 1)	15.0	mJ
dv/dt	Peak Diode Recovery dv/dt (Note 3)	7.0	V/ns
P_D	Power Dissipation ($T_C = 25^\circ C$) - Derate above $25^\circ C$	150	W
		1.00	W/ $^\circ C$
T_J, T_{STG}	Operating and Storage Temperature Range	-55 to +175	$^\circ C$
T_L	Maximum lead temperature for soldering purposes, 1/8" from case for 5 seconds	300	$^\circ C$

Thermal Characteristics

Symbol	Parameter	Typ	Max	Units
$R_{\theta JC}$	Thermal Resistance, Junction-to-Case	--	1.00	$^\circ C/W$
$R_{\theta CS}$	Thermal Resistance, Case-to-Sink	0.5	--	$^\circ C/W$
$R_{\theta JA}$	Thermal Resistance, Junction-to-Ambient	--	62.5	$^\circ C/W$

Electrical Characteristics

$T_C = 25^\circ\text{C}$ unless otherwise noted

Symbol	Parameter	Test Conditions	Min	Typ	Max	Units
Off Characteristics						
BV_{DSS}	Drain-Source Breakdown Voltage	$V_{GS} = 0\text{ V}, I_D = 250\ \mu\text{A}$	60	--	--	V
$\Delta BV_{DSS} / \Delta T_J$	Breakdown Voltage Temperature Coefficient	$I_D = 250\ \mu\text{A}$, Referenced to 25°C	--	0.07	--	$\text{V}/^\circ\text{C}$
I_{DSS}	Zero Gate Voltage Drain Current	$V_{DS} = 60\text{ V}, V_{GS} = 0\text{ V}$	--	--	1	μA
		$V_{DS} = 48\text{ V}, T_C = 150^\circ\text{C}$	--	--	10	μA
I_{GSSF}	Gate-Body Leakage Current, Forward	$V_{GS} = 25\text{ V}, V_{DS} = 0\text{ V}$	--	--	100	nA
I_{GSSR}	Gate-Body Leakage Current, Reverse	$V_{GS} = -25\text{ V}, V_{DS} = 0\text{ V}$	--	--	-100	nA

On Characteristics

$V_{GS(th)}$	Gate Threshold Voltage	$V_{DS} = V_{GS}, I_D = 250\ \mu\text{A}$	2.0	--	4.0	V
$R_{DS(on)}$	Static Drain-Source On-Resistance	$V_{GS} = 10\text{ V}, I_D = 32.5\text{ A}$	--	0.012	0.016	Ω
g_{FS}	Forward Transconductance	$V_{DS} = 25\text{ V}, I_D = 32.5\text{ A}$ (Note 4)	--	48	--	S

Dynamic Characteristics

C_{iss}	Input Capacitance	$V_{DS} = 25\text{ V}, V_{GS} = 0\text{ V},$ $f = 1.0\text{ MHz}$	--	1850	2410	pF
C_{oss}	Output Capacitance		--	700	910	pF
C_{rss}	Reverse Transfer Capacitance		--	100	130	pF

Switching Characteristics

$t_{d(on)}$	Turn-On Delay Time	$V_{DD} = 30\text{ V}, I_D = 32.5\text{ A},$ $R_G = 25\ \Omega$	--	20	50	ns
t_r	Turn-On Rise Time		--	160	330	ns
$t_{d(off)}$	Turn-Off Delay Time		--	90	190	ns
t_f	Turn-Off Fall Time		(Note 4, 5)	--	105	220
Q_g	Total Gate Charge	$V_{DS} = 48\text{ V}, I_D = 65\text{ A},$ $V_{GS} = 10\text{ V}$	--	48	65	nC
Q_{gs}	Gate-Source Charge		--	12	--	nC
Q_{gd}	Gate-Drain Charge		(Note 4, 5)	--	19.5	--

Drain-Source Diode Characteristics and Maximum Ratings

I_S	Maximum Continuous Drain-Source Diode Forward Current	--	--	65	A	
I_{SM}	Maximum Pulsed Drain-Source Diode Forward Current	--	--	260	A	
V_{SD}	Drain-Source Diode Forward Voltage	$V_{GS} = 0\text{ V}, I_S = 65\text{ A}$	--	--	1.5	V
t_{rr}	Reverse Recovery Time	$V_{GS} = 0\text{ V}, I_S = 65\text{ A},$	--	62	--	ns
Q_{rr}	Reverse Recovery Charge	$di_F / dt = 100\text{ A}/\mu\text{s}$ (Note 4)	--	110	--	nC

Notes:

1. Repetitive Rating : Pulse width limited by maximum junction temperature
2. $L = 180\ \mu\text{H}, I_{AS} = 65\text{ A}, V_{DD} = 25\text{ V}, R_G = 25\ \Omega$, Starting $T_J = 25^\circ\text{C}$
3. $I_{SD} \leq 65\text{ A}, di/dt \leq 300\text{ A}/\mu\text{s}, V_{DD} \leq BV_{DSS}$, Starting $T_J = 25^\circ\text{C}$
4. Pulse Test : Pulse width $\leq 300\ \mu\text{s}$, Duty cycle $\leq 2\%$
5. Essentially independent of operating temperature

Typical Characteristics

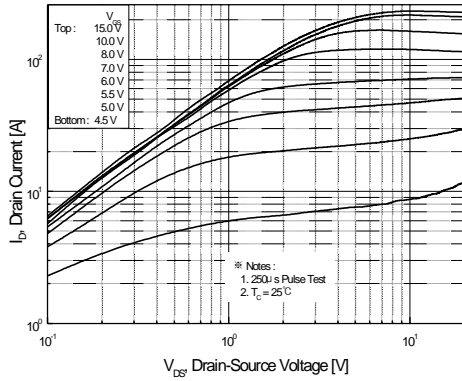

Figure 1. On-Region Characteristics

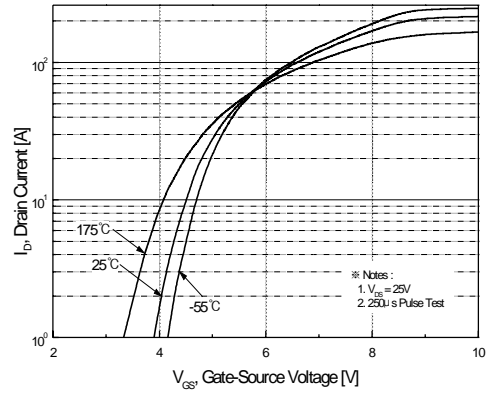

Figure 2. Transfer Characteristics

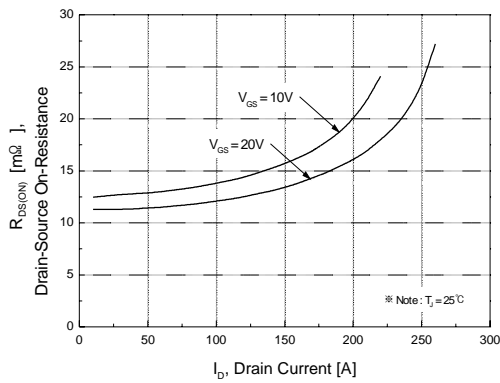

Figure 3. On-Resistance Variation vs. Drain Current and Gate Voltage

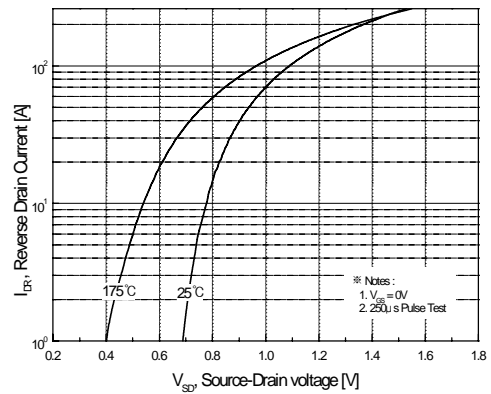

Figure 4. Body Diode Forward Voltage Variation vs. Source Current and Temperature

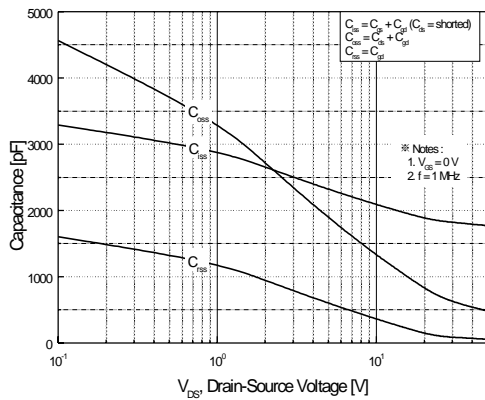

Figure 5. Capacitance Characteristics

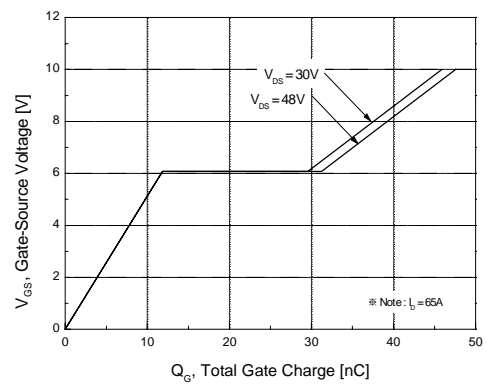

Figure 6. Gate Charge Characteristics

Typical Characteristics (Continued)

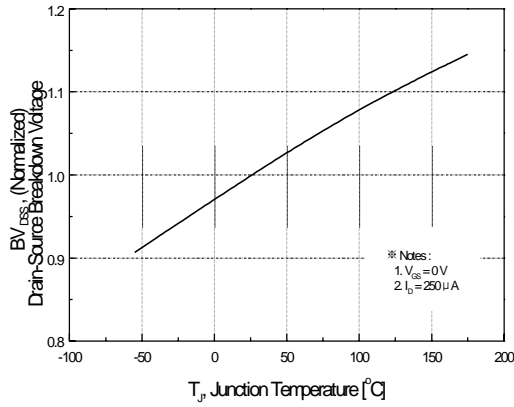

Figure 7. Breakdown Voltage Variation vs. Temperature

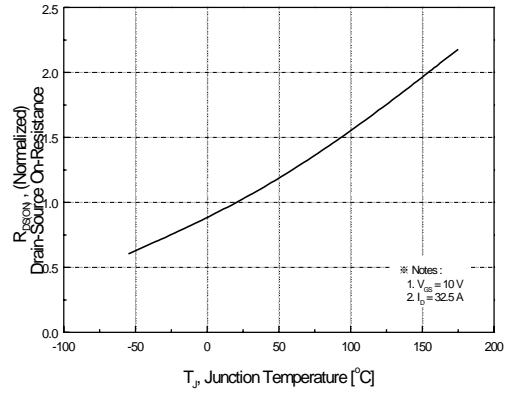

Figure 8. On-Resistance Variation vs. Temperature

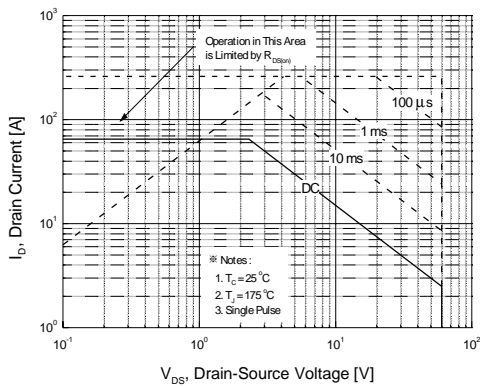

Figure 9. Maximum Safe Operating Area

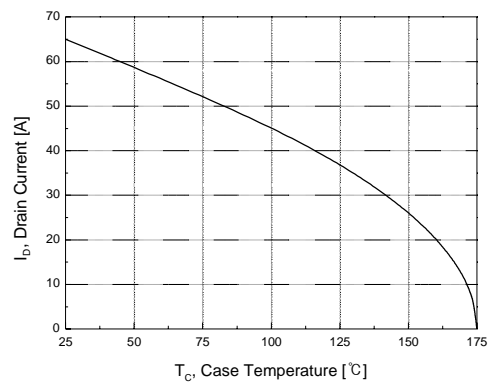

Figure 10. Maximum Drain Current vs. Case Temperature

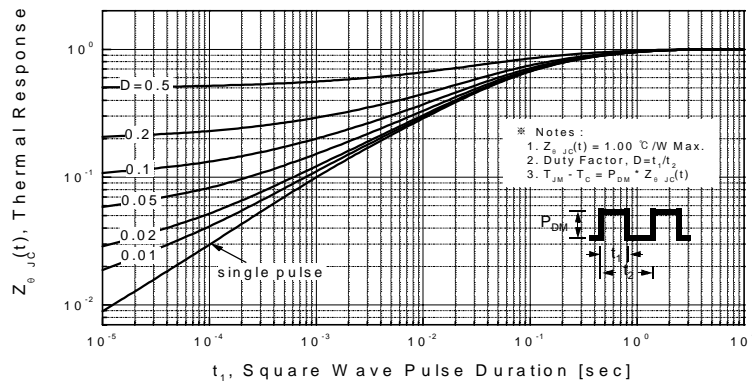
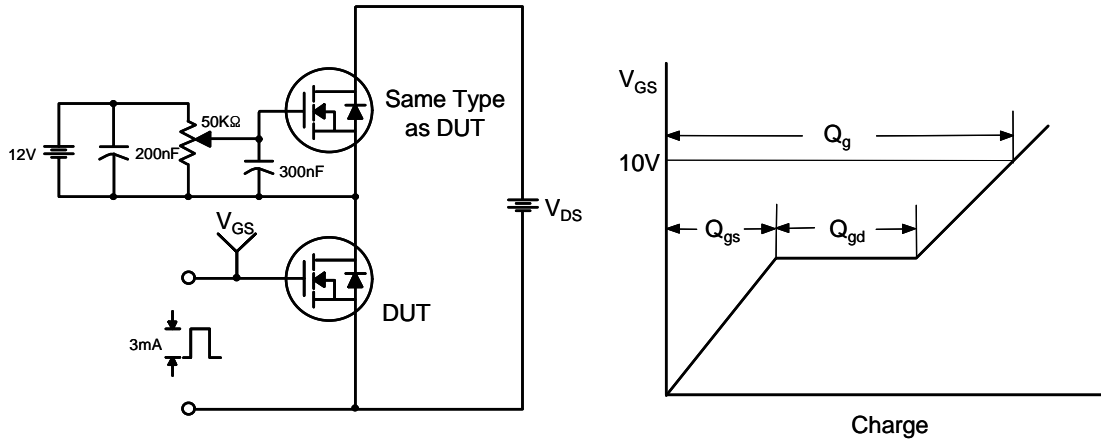
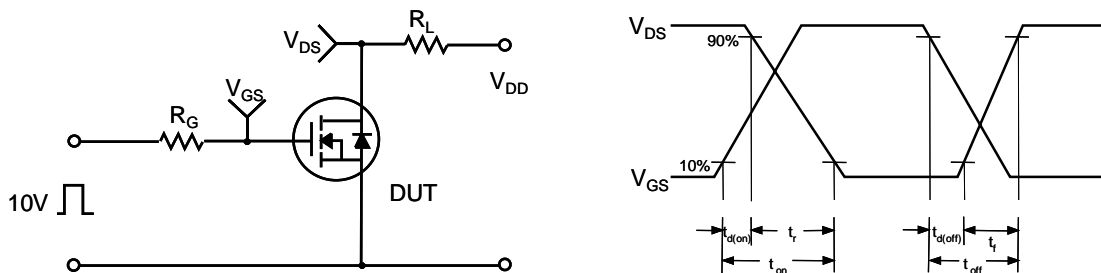

Figure 11. Transient Thermal Response Curve

Gate Charge Test Circuit & Waveform



Resistive Switching Test Circuit & Waveforms



Unclamped Inductive Switching Test Circuit & Waveforms

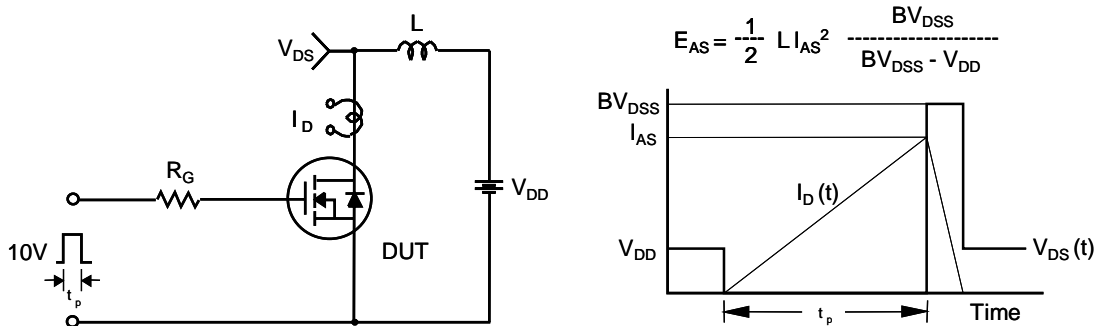

Peak Diode Recovery dv/dt Test Circuit & Waveforms

