



Micro Commercial Components  
 21201 Itasca Street Chatsworth  
 CA 91311  
 Phone: (818) 701-4933  
 Fax: (818) 701-4939

# FR6A THRU FR6M

## 6 Amp Fast Recovery Rectifier 50 to 1000 Volts

### Features

- Low Leakage
- Low Forward Voltage Drop
- High Current Capability
- Fast Switching Speed For High Efficiency

### Maximum Ratings

- Operating Temperature: -55°C to +150°C
- Storage Temperature: -55°C to +150°C

MCC Part Number	Maximum Recurrent Peak Reverse Voltage	Maximum RMS Voltage	Maximum DC Blocking Voltage
FR6A	50V	35V	50V
FR6B	100V	70V	100V
FR6D	200V	140V	200V
FR6G	400V	280V	400V
FR6J	600V	420V	600V
FR6K	800V	560V	800V
FR6M	1000V	700V	1000V

### DO-214AB (SMCJ) (Round Lead)

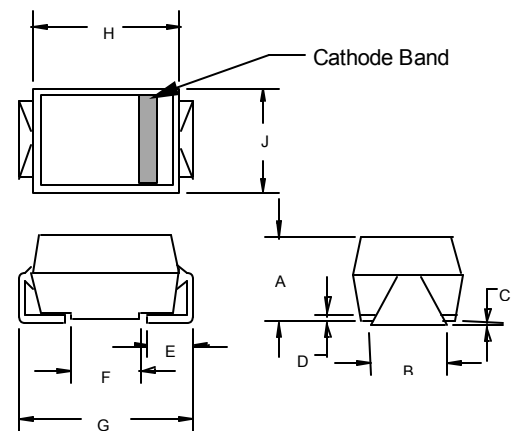

DIM	DIMENSIONS				NOTE
	INCHES		MM		
A	.200	.214	5.08	5.43	
B	.177	.203	4.70	5.30	
C	.002	.005	.05	.13	
D	---	.02	---	.51	
E	.053	.067	1.35	1.70	
F	.168	.179	4.27	4.55	
G	.320	.330	8.13	8.38	
H	.239	.243	6.08	6.18	
J	.234	.240	5.95	6.10	

### SUGGESTED SOLDER PAD LAYOUT

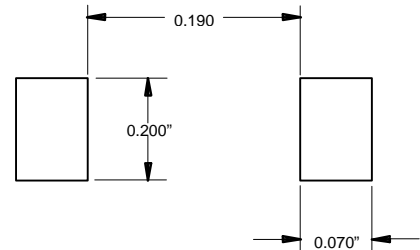

### Electrical Characteristics @ 25°C Unless Otherwise Specified

Average Forward Current	$I_{F(AV)}$	6 A	$T_A = 55^\circ\text{C}$
Peak Forward Surge Current	$I_{FSM}$	300A	8.3ms, half sine
Maximum Instantaneous Forward Voltage	$V_F$	1.30V	$I_{FM} = 6.0A;$ $T_A = 25^\circ\text{C}$
Maximum DC Reverse Current At Rated DC Blocking Voltage	$I_R$	10 $\mu$ A 50 $\mu$ A	$T_A = 25^\circ\text{C}$ $T_A = 55^\circ\text{C}$
Maximum Reverse Recovery Time	$T_{rr}$	150ns 250ns 500ns	$I_F=0.5A, I_R=1.0A,$ $I_{rr}=0.25A$
			FR6A-FR6G FR6J FR6K-FR6M

\*Pulse Test: Pulse Width 300 $\mu$ sec, Duty Cycle 1%

# FR6A thru FR6M

Figure 1  
Typical Forward Characteristics

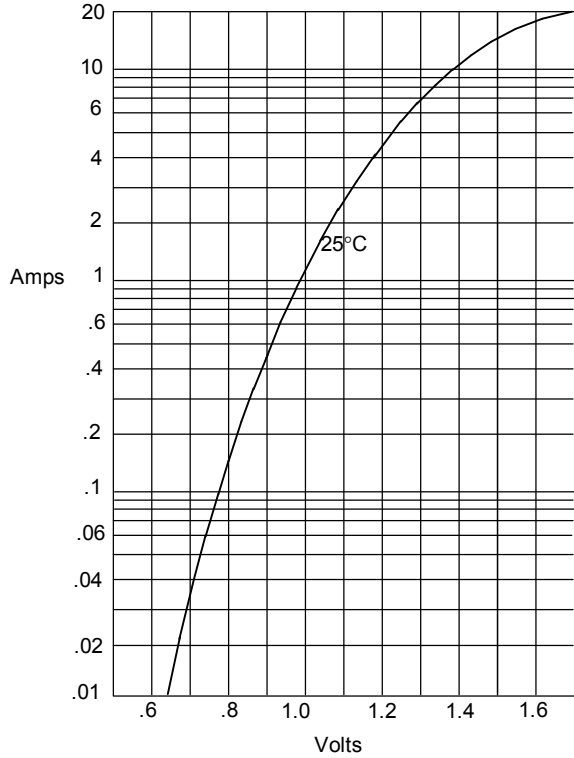

Instantaneous Forward Current - Amperes versus  
Instantaneous Forward Voltage - Volts

Figure 2  
Forward Derating Curve

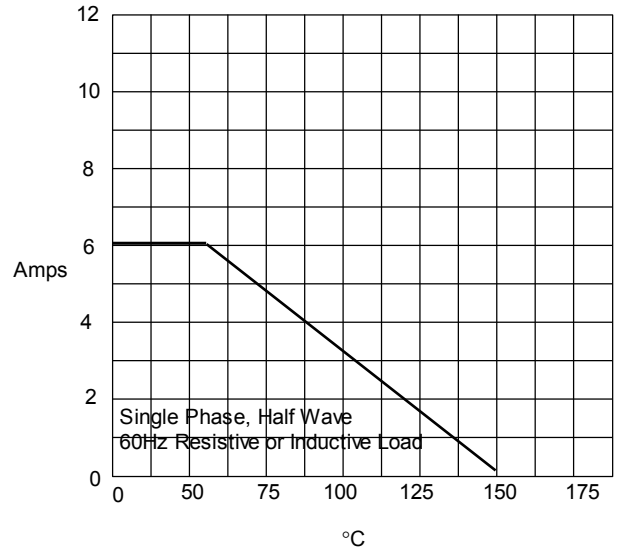
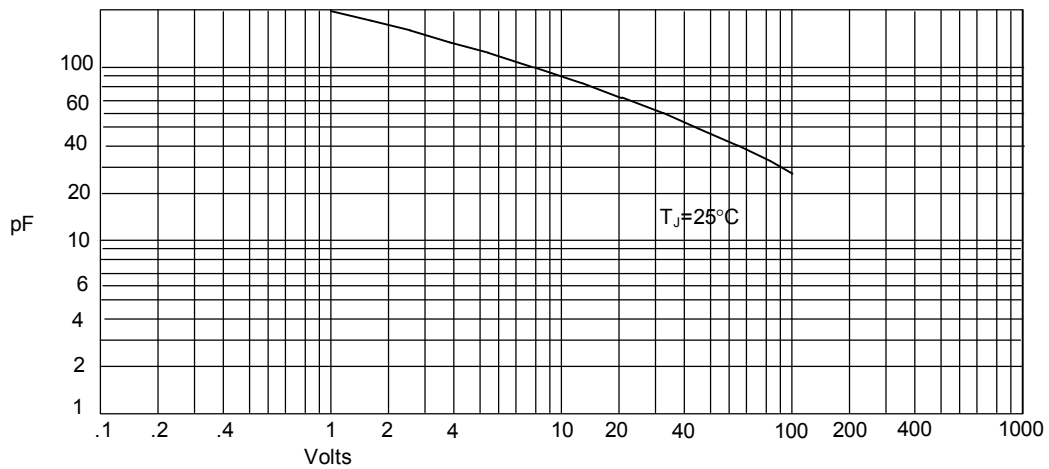

Figure 3  
Junction Capacitance



Junction Capacitance - pF versus  
Reverse Voltage - Volts

# FR6A thru FR6M

Figure 4  
Peak Forward Surge Current

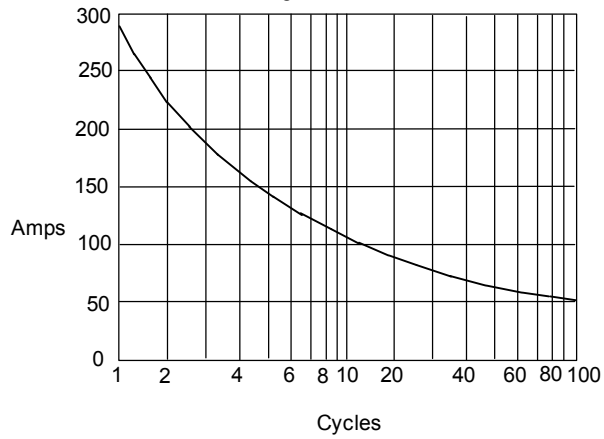

Peak Forward Surge Current - Amperes versus  
Number Of Cycles At 60Hz - Cycles

Figure 5  
Reverse Recovery Time Characteristic And Test Circuit Diagram

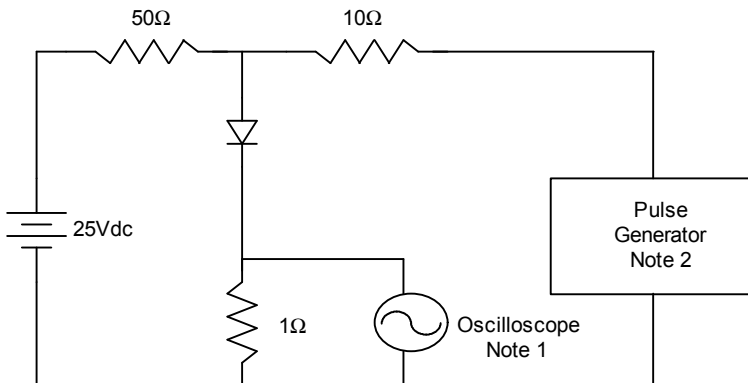

- Notes:
1. Rise Time = 7ns max.  
Input impedance = 1 megohm, 22pF
  2. Rise Time = 10ns max.  
Source impedance = 50 ohms
  3. Resistors are non-inductive

