



Micro Commercial Components



Micro Commercial Components
20736 Marilla Street Chatsworth
CA 91311
Phone: (818) 701-4933
Fax: (818) 701-4939

FR6J

6 Amp Fast Recovery Rectifier 600 Volts

Features

- Lead Free Finish/Rohs Compliant (Note1) ("P" Suffix designates Compliant. See ordering information)
- Fast Switching Speed For High Efficiency
- Epoxy meets UL 94 V-0 flammability rating
- Moisture Sensitivity Level 1
- Marking : Cathode band and type number
- Halogen free available upon request by adding suffix "-HF"

Maximum Ratings

- Operating Temperature: -55°C to +150°C
- Storage Temperature: -55°C to +150°C

MCC Part Number	Maximum Recurrent Peak Reverse Voltage	Maximum RMS Voltage	Maximum DC Blocking Voltage
FR6J	600V	420V	600V

DO-214AB (HSMC) (Round Lead)

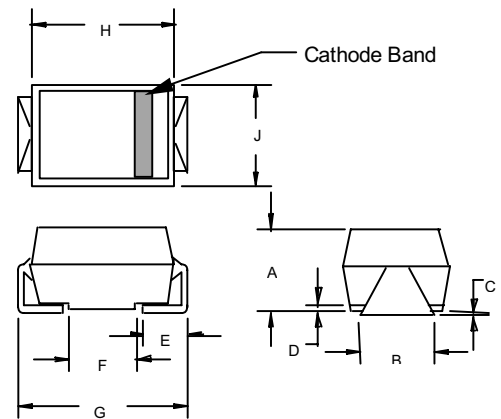

DIM	DIMENSIONS				NOTE
	INCHES		MM		
A	.200	.214	5.08	5.43	
B	.177	.203	4.70	5.30	
C	.002	.005	.05	.13	
D	—	.02	—	.51	
E	.047	.056	1.20	1.42	
F	.168	.179	4.27	4.55	
G	.309	.322	7.85	8.18	
H	.239	.243	6.08	6.18	
J	.234	.240	5.95	6.10	

SUGGESTED SOLDER PAD LAYOUT

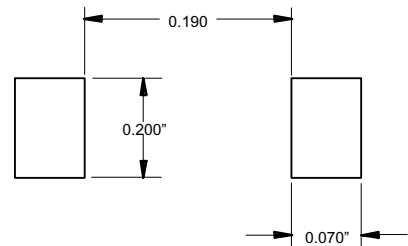

Electrical Characteristics @ 25°C Unless Otherwise Specified

Average Forward Current	$I_{F(AV)}$	6 A	$T_A = 55^\circ\text{C}$
Peak Forward Surge Current	I_{FSM}	300A	8.3ms, half sine
Maximum Instantaneous Forward Voltage	V_F	1.30V	$I_{FM} = 6.0A;$ $T_A = 25^\circ\text{C}^*$
Maximum DC Reverse Current At Rated DC Blocking Voltage	I_R	10µA 50µA	$T_A = 25^\circ\text{C}$ $T_A = 55^\circ\text{C}$
Maximum Reverse Recovery Time FR6J	T_{rr}	250ns	$I_F=0.5A, I_R=1.0A,$ $I_{rr}=0.25A$

*Pulse Test: Pulse Width 300µsec, Duty Cycle 1%

Note: 1. High Temperature Solder Exemptions Applied, see EU Directive Annex 7.

FR6J

Figure 1
Typical Forward Characteristics

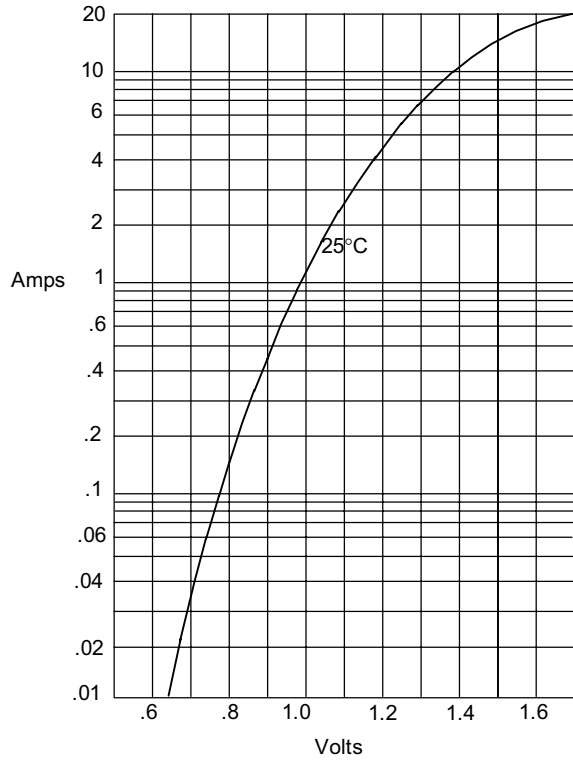

Instantaneous Forward Current - Amperes versus
Instantaneous Forward Voltage - Volts

Figure 2
Forward Derating Curve

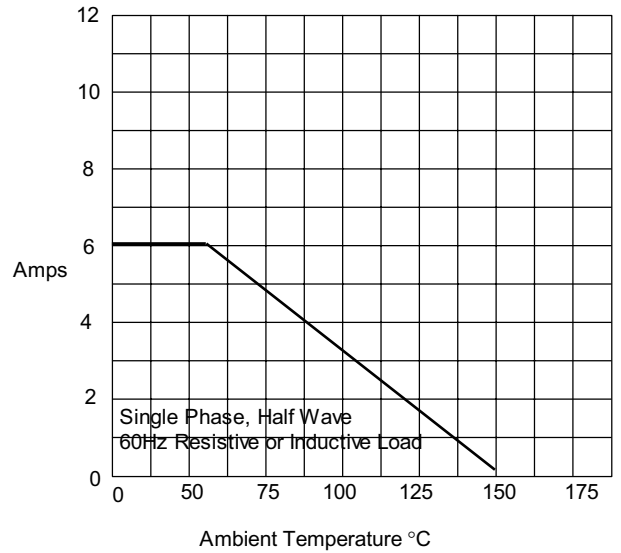
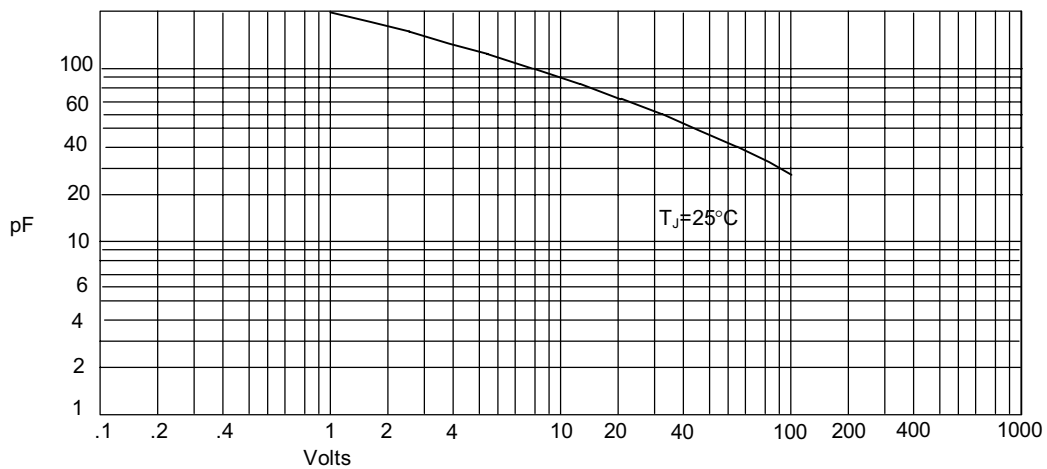

Figure 3
Junction Capacitance



Junction Capacitance - pF versus
Reverse Voltage - Volts

FR6J

Figure 4
Peak Forward Surge Current

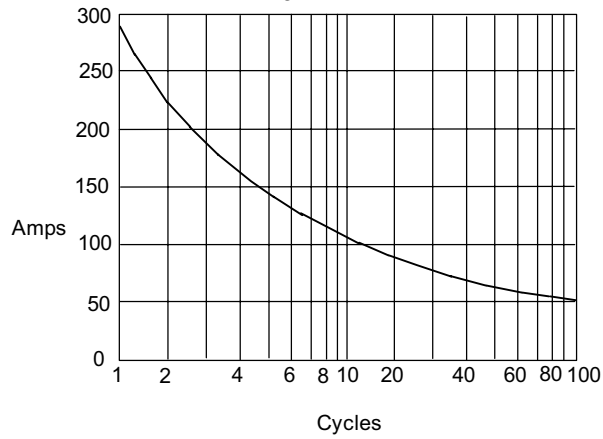

Peak Forward Surge Current - Amperes versus
Number Of Cycles At 60Hz - Cycles

Figure 5
Reverse Recovery Time Characteristic And Test Circuit Diagram

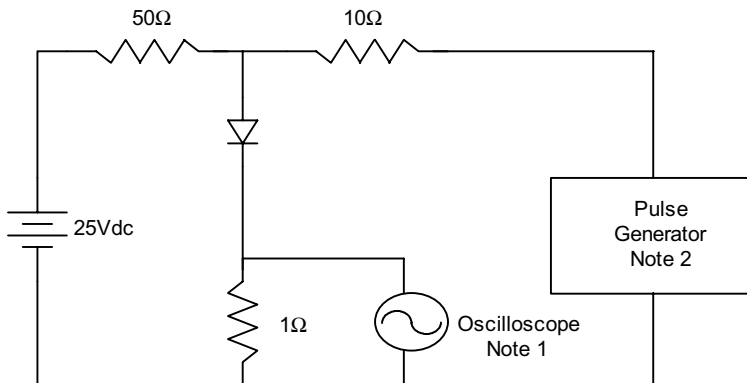

- Notes:
1. Rise Time = 7ns max.
Input impedance = 1 megohm, 22pF
 2. Rise Time = 10ns max.
Source impedance = 50 ohms
 3. Resistors are non-inductive

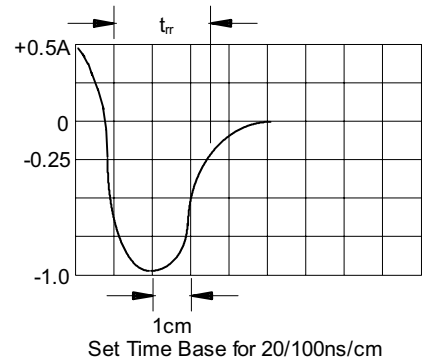

Ordering Information :

Device	Packing
Part Number-TP	Tape&Reel: 1.5Kpcs/Reel

Note : Adding "-HF" suffix for halogen free, eg. Part Number-TP-HF

*****IMPORTANT NOTICE*****

Micro Commercial Components Corp. reserves the right to make changes without further notice to any product herein to make corrections, modifications , enhancements , improvements , or other changes . **Micro Commercial Components Corp .** does not assume any liability arising out of the application or use of any product described herein; neither does it convey any license under its patent rights ,nor the rights of others . The user of products in such applications shall assume all risks of such use and will agree to hold **Micro Commercial Components Corp .** and all the companies whose products are represented on our website, harmless against all damages.

*****LIFE SUPPORT*****

MCC's products are not authorized for use as critical components in life support devices or systems without the express written approval of Micro Commercial Components Corporation.

*****CUSTOMER AWARENESS*****

Counterfeiting of semiconductor parts is a growing problem in the industry. Micro Commercial Components (MCC) is taking strong measures to protect ourselves and our customers from the proliferation of counterfeit parts. MCC strongly encourages customers to purchase MCC parts either directly from MCC or from Authorized MCC Distributors who are listed by country on our web page cited below. Products customers buy either from MCC directly or from Authorized MCC Distributors are genuine parts, have full traceability, meet MCC's quality standards for handling and storage. **MCC will not provide any warranty coverage or other assistance for parts bought from Unauthorized Sources.** MCC is committed to combat this global problem and encourage our customers to do their part in stopping this practice by buying direct or from authorized distributors.