



**FT500AH**

T-25-19

Powerex, Inc. Hillis Street, Youngwood, Pennsylvania 15697 (412) 925-7272  
 Powerex Europe, S.A., 428 Ave. G. Durand, BP107, 72003 LeMans, France (43) 72.75.15

**Phase Control SCR**  
**320 Amperes Avg**  
**3000-4000 Volts**

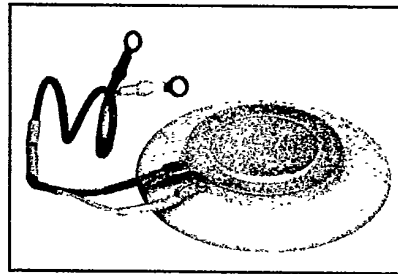
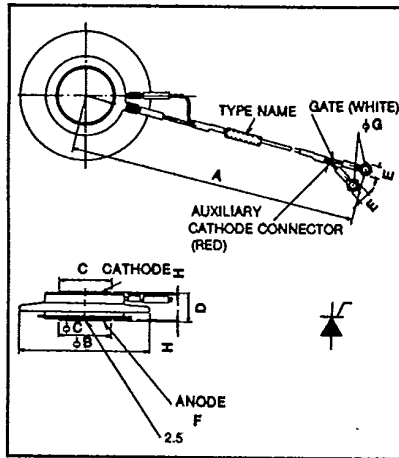

**FT500AH**  
**Phase Control SCR**  
 320 Amperes/3000-4000 Volts

**FT500AH**  
**Outline Drawing**

Dimensions	Inches	Metric
A	11.42 ± .40	290 ± 10
φB	3.346	85
φC	1.339	34
D	.71 ± .02	18 ± 0.5
E	.30	7.5
F	M5	M5 × 0.8
φG	.169	4.3
H	.015 Min	0.4 Min

**Description**

Powerex Silicon Controlled Rectifiers (SCR) are designed for phase control applications. These are all-diffused, Press-Pak (Pow-R-Disc) devices employing center-fired gate.

**Features:**

- Low On-State Voltage
- High di/dt
- High dv/dt
- Hermetic Packaging
- Excellent Surge and I<sup>2</sup>t Ratings

**Applications:**

- Power Supplies
- Battery Chargers
- Motor Control
- Light Dimmers
- VAR Generators

**Ordering Information**

Example: Select the complete nine digit part number you desire from the table - i.e. FT500AH-60 is a 3000 Volt, 320 Ampere Phase Control SCR.

Type	Voltage		Current
	V <sub>ORM</sub> V <sub>RRM</sub>	Code	
FT500AH	3000	-60	320
	3500	-70	
	4000	-80	



Powerex, Inc., Hillis Street, Youngwood, Pennsylvania 15697 (412) 925-7272

Powerex Europe, S.A., 428 Ave. G. Durand, BP107, 72003 LeMans, France (43) 72.75.15

**FT500AH**

**Phase Control SCR**

320 Amperes Avg/3000-4000 Volts

**Absolute Maximum Ratings**

	Symbol	FT500AH	Units
RMS On-State Current	$I_{T(RMS)}$	500	Amperes
Average On-State Current	$I_{T(av)}$	320	Amperes
Peak One-Cycle Surge (Non Repetitive) On-State Current (60Hz)	$I_{TSM}$	5000	Amperes
Peak One-Cycle Surge (Non-Repetitive) On-State Current (50Hz)	$I_{TSM}$	4550	Amperes
Critical Rate-of-Rise of On-State Current (Non-Repetitive)	$di/dt$	300	Amperes/ $\mu$ s
Critical Rate-of-Rise of On-State Current (Repetitive)	$di/dt$	100	Amperes/ $\mu$ s
$I^2t$ (for Fusing), one cycle at 60Hz	$I^2t$	$1.0 \times 10^5$	$A^2sec$
Peak Gate Power Dissipation	$P_{GM}$	10	Watts
Average Gate Power Dissipation	$P_{G(av)}$	3	Watts
Storage Temperature	$T_{STG}$	-40 to 150	$^{\circ}C$
Operating Temperature	$T_J$	-40 to 125	$^{\circ}C$
Mounting Force <sup>ⓐ</sup>		3000 to 4000	lb.
Mounting Force <sup>ⓐ</sup>		1350 to 1800	kg

<sup>ⓐ</sup> Consult recommended mounting procedures.



Powerex, Inc., Hillis Street, Youngwood, Pennsylvania 15697 (412) 925-7272  
 Powerex Europe, S.A., 428 Ave. G. Durand, BP107, 72003 LeMans, France (43) 72.75.15

**FT500AH**  
**Phase Control SCR**  
 320 Amperes Avg/3000-4000 Volts

### Electrical and Thermal Characteristics

Characteristics	Symbol	Test Conditions	FT500AH	Units
<b>Voltage—Blocking State Maximums</b>				
Forward Leakage, Peak	$I_{DRM}$	$T_J = 125^\circ\text{C}$ , $V_{RRM}$ applied	30	mA
Reverse Leakage, Peak	$I_{RRM}$	$T_J = 125^\circ\text{C}$ , $V_{RRM}$ applied	30	mA
<b>Current—Conducting State Maximums</b>				
Peak On-State Voltage	$V_{TM}$	$I_{TM} = 1000\text{A}$ , $T_J = 125^\circ\text{C}$	2.85	Volts
<b>Switching</b>				
Min. Critical dv/dt exponential to $V_{DRM}$	dv/dt	$T_J = 125^\circ\text{C}$ , $V_D = \frac{1}{2}V_{DRM}$	200	V/ $\mu\text{sec}$
<b>Thermal</b>				
Maximum Thermal Resistance, <sup>Ⓞ</sup> double sided cooling Junction to Sink	$R_{\theta JS}$		.05	$^\circ\text{C}/\text{Watt}$
<b>Gate—Maximum Parameters</b>				
Gate Current to Trigger	$I_{GT}$	$V_D = 6\text{V}$ , $T_J = 25^\circ\text{C}$ , $R_L = 2\Omega$	200	mA
Gate Voltage to Trigger	$V_{GT}$	$V_D = 6\text{V}$ , $T_J = 25^\circ\text{C}$ , $R_L = 2\Omega$	2.5	Volts
Non-Triggering Gate Voltage	$V_{GDM}$	$T_J = 125^\circ\text{C}$ , $V_D = 1/2V_{DRM}$	.20	Volts
Peak Forward Gate Current	$I_{GTM}$		4	Amperes
Peak Reverse Gate Voltage	$V_{GRM}$		5	Volts

<sup>Ⓞ</sup> Consult recommended mounting procedures.



Powerex, Inc., Hillis Street, Youngwood, Pennsylvania 15697 (412) 925-7272  
 Powerex Europe, S.A., 428 Ave. G. Durand, BP107, 72003 LeMans, France (43) 72.75.15

**FT500AH**  
 Phase Control SCR  
 320 Amperes Avg/3000-4000 Volts

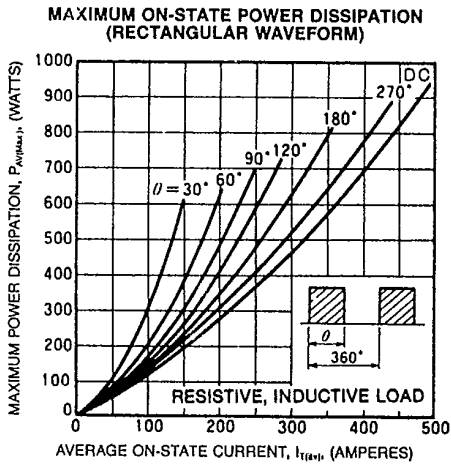
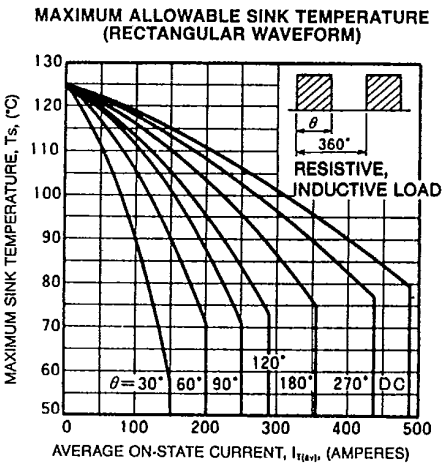
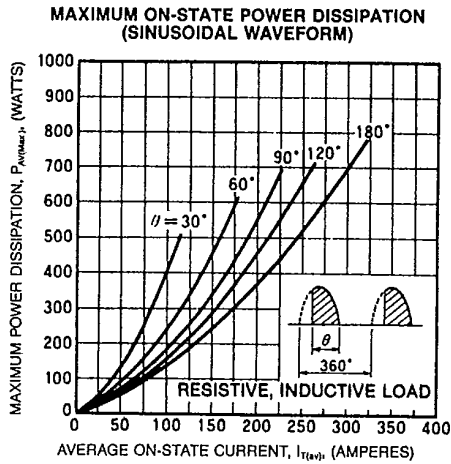
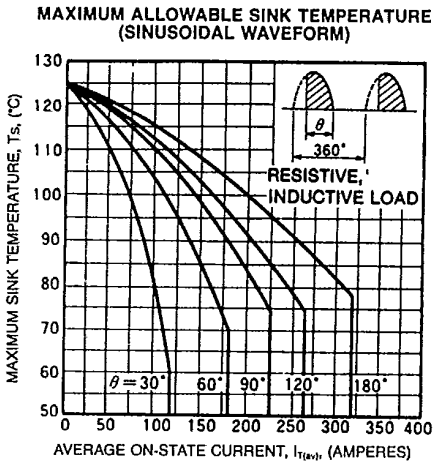
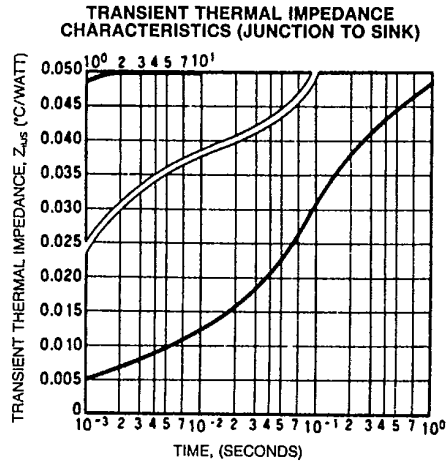
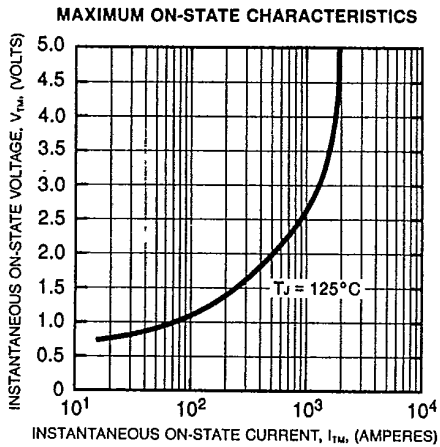



Powerex, Inc., Hillis Street, Youngwood, Pennsylvania 15697 (412) 925-7272  
 Powerex Europe, S.A., 428 Ave. G. Durand, BP107, 72003 LeMans, France (43) 72.75.15

**FT500AH**  
 Phase Control SCR  
 320 Amperes Avg/3000-4000 Volts

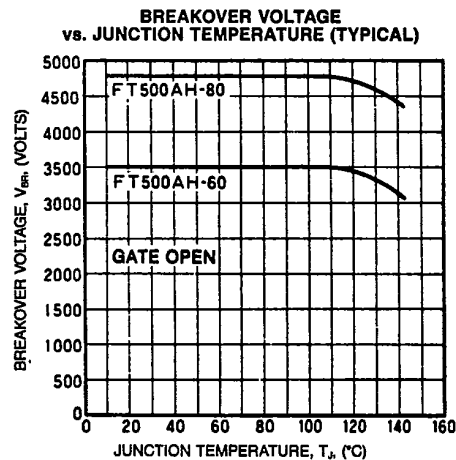
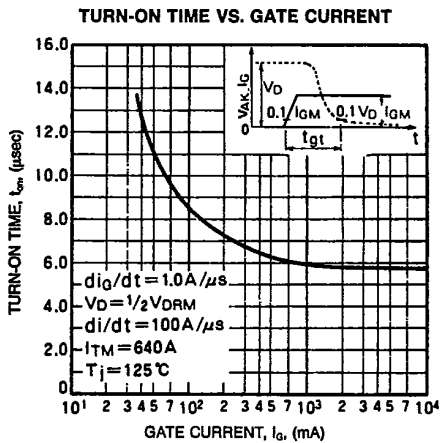
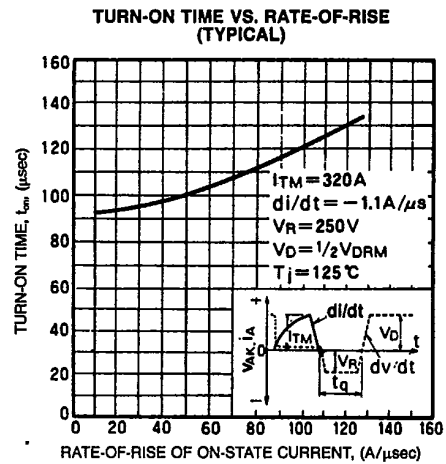
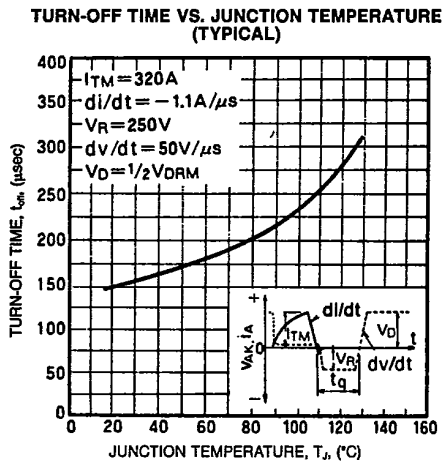
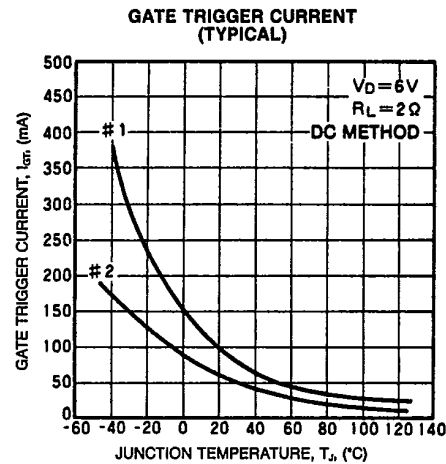
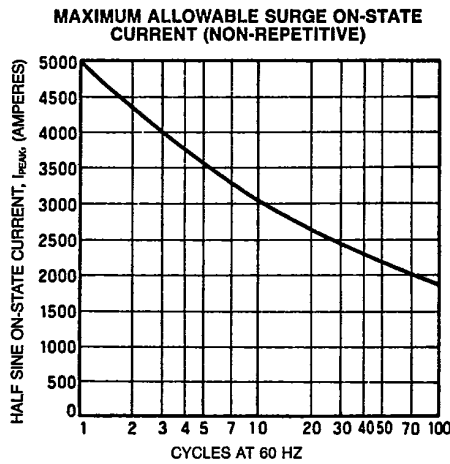



Powerex, Inc., Hillis Street, Youngwood, Pennsylvania 15697 (412) 925-7272  
 Powerex Europe, S.A., 428 Ave. G. Durand, BP107, 72003 LeMans, France (43) 72.75.15

**FT500AH**  
 Phase Control SCR  
 320 Amperes Avg/3000-4000 Volts

**REVERSE RECOVERED CHARGE (TYPICAL)**

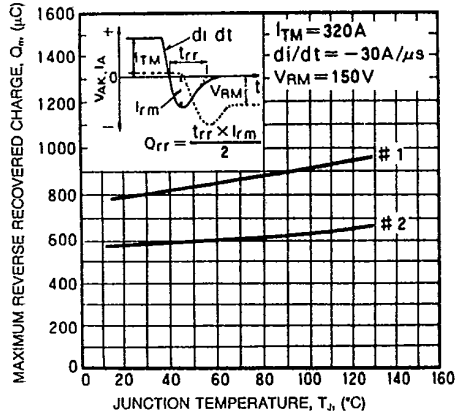

**GATE CHARACTERISTICS**

