

G62VP

CMOS Positive Voltage Regulator

Description

The G62VP series is a group of positive voltage output, three-pin regulators, that provide a high current even when the input/output voltage differential is small. Low power consumption and high accuracy is achieved through CMOS and laser trimming technologies.

The G62VP consists of a high-precision voltage reference, an error amplification circuit, and a current limited output driver. Transient response to load variations have improved in comparison to the existing series.

Features

- Maximum Output Current: 250mA (within max. power dissipation, $V_{out}=5.0V$)
- Output Voltage Range: 1.5V ~ 6V in 0.1V increments
- Low Power Consumption: Typ. 2.0uA @ $V_{OUT}=5.0V$
- Output Voltage Temperature Characteristics: Typ. $\pm 100\text{ppm}/^\circ\text{C}$
- Input Stability: Typ. 0.2%/V
- Small Input-Output Differential: $I_{OUT}=100\text{mA}$ @ $V_{OUT}=5.0V$ with a 0.12V differential
- Highly Accurate: Output voltage $\pm 2\%$

Applications

- Battery Powered Equipment
- Palmtops
- Portable Cameras and Video Recorders
- Reference Voltage Source

Package Dimensions

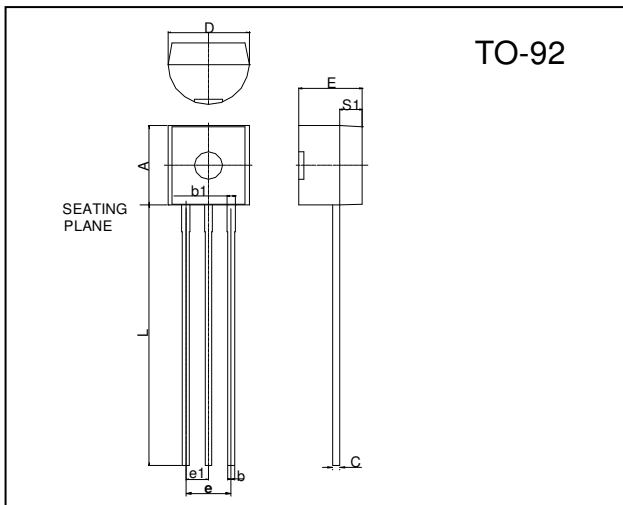

Marking :

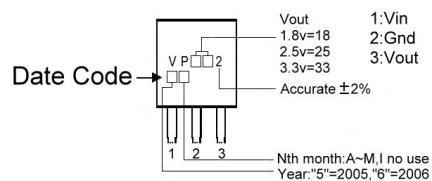

REF.	Millimeter		REF.	Millimeter	
	Min.	Max.		Min.	Max.
A	4.45	4.7	D	4.44	4.7
S1	1.02	-	E	3.30	3.81
b	0.36	0.51	L	12.70	-
b1	0.36	0.76	e1	1.150	1.390
C	0.36	0.51	e	2.42	2.66

Typical Application Circuit

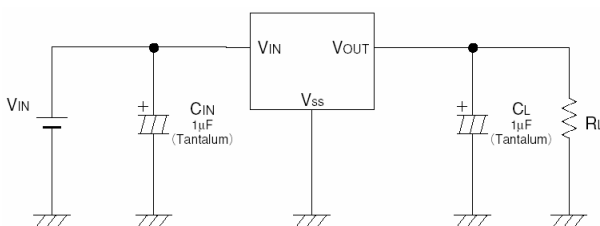

Block Diagram

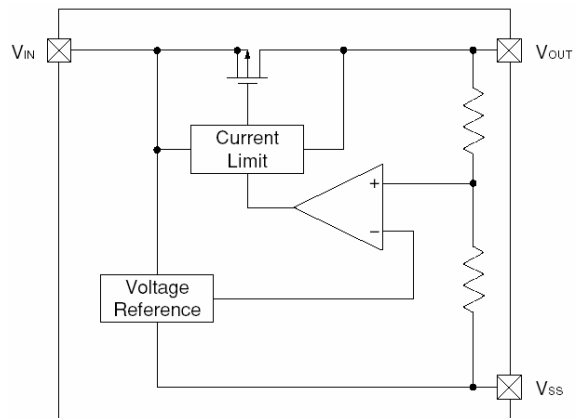

Absolute Maximum Ratings Ta=25°C

Parameter	Symbol	Ratings	Unit
Input Voltage	V _{IN}	12	V
Output Current	I _{OUT}	500	mA
Output Voltage	V _{OUT}	V _{SS} -0.3 ~V _{IN} +0.3	V
Operating Ambient Temperature	Topr	-40 ~ +85	°C
Storage Temperature	Tstg	-40 ~ +125	°C
Continuous Total Power Dissipation	PD	300	mW

Electrical Characteristics Ta=25°C**G62VP-50 V_{OUT} (T) =5.0V (Note1)**

Parameter	Symbol	Condition	Min	TYP	Max	Unit
Output Voltage	V _{OUT} (E) (Note2)	V _{IN} =6.0V, I _{OUT} =40mA	4.900	5.000	5.100	V
Max. Output Current	I _{OUT max}	V _{IN} =6V, V _{OUT} (E)≥4.5V	250	-	-	mA
Load Stability	ΔV _{OUT}	V _{IN} =6V, I _{OUT} =1mA to 100mA	-	40	80	mV
Input-Output Voltage Differential (Note3)	V _{dif1}	I _{OUT} =100mA	-	120	300	mV
	V _{dif2}	I _{OUT} =200mA	-	380	600	
Supply Current	I _{SS}	V _{IN} =6V	-	2.0	5.0	μA
Input Stability	$\frac{\Delta V_{OUT}}{\Delta V_{IN} \cdot V_{OUT}}$	I _{OUT} =40mA V _{IN} =6V to 10V	-	0.2	0.3	%/V
Input Voltage	V _{IN}		-	-	10	V
Output Voltage Temperature Characteristics	$\frac{\Delta V_{OUT}}{\Delta Topr \cdot V_{OUT}}$	I _{OUT} =40mA -40°C ≤ Topr ≤ 85°C	-	±100	-	ppm/°C

Note 1: V_{OUT} (T) =Specified Output Voltage.

2: V_{OUT} (E) =Effective Output Voltage (i.e. the output voltage when "V_{OUT} (T) +1.0V" is provided at the V_{IN} pin while maintaining a certain I_{OUT} value).

3: V_{dif}=V_{IN} (Note4) -V_{OUT} (E)

4: V_{IN1}=The input voltage at the time 98% of V_{OUT} (E) is output (input voltage has been gradually reduced).

G62VP-40 V_{OUT} (T) =4.0V (Note1)

Parameter	Symbol	Condition	Min	TYP	Max	Unit
Output Voltage	V _{OUT} (E) (Note2)	V _{IN} =5.0V, I _{OUT} =40mA	3.920	4.000	4.080	V
Max. Output Current	I _{OUT max}	V _{IN} =5V, V _{OUT} (E)≥3.6V	200	-	-	mA
Load Stability	ΔV _{OUT}	V _{IN} =5V, I _{OUT} =1mA to 100mA	-	45	90	mV
Input-Output Voltage Differential (Note3)	V _{dif1}	I _{OUT} =100mA	-	170	330	mV
	V _{dif2}	I _{OUT} =200mA	-	400	630	
Supply Current	I _{SS}	V _{IN} =5V	-	2.0	4.5	μA
Input Stability	$\frac{\Delta V_{OUT}}{\Delta V_{IN} \cdot V_{OUT}}$	I _{OUT} =40mA V _{IN} =5V to 10V	-	0.2	0.3	%/V
Input Voltage	V _{IN}		-	-	10	V
Output Voltage Temperature Characteristics	$\frac{\Delta V_{OUT}}{\Delta Topr \cdot V_{OUT}}$	I _{OUT} =40mA -40°C ≤ Topr ≤ 85°C	-	±100	-	ppm/°C

G62VP-30 V_{OUT} (T) =3.0V (Note1)

Parameter	Symbol	Condition	Min	TYP	Max	Unit
Output Voltage	V _{OUT(E)} (Note2)	V _{IN} =4.0V, I _{OUT} =40mA	2.940	3.000	3.060	V
Max. Output Current	I _{OUT max}	V _{IN} =4V, V _{OUT(E)} ≥2.7V	150	-	-	mA
Load Stability	ΔV _{OUT}	V _{IN} =4V, I _{OUT} =1mA to 80mA	-	45	90	mV
Input-Output Voltage Differential (Note3)	V _{dif1}	I _{OUT} =80mA	-	180	360	mV
	V _{dif2}	I _{OUT} =160mA	-	400	700	
Supply Current	I _{SS}	V _{IN} =4V	-	2.0	4.5	μA
Input Stability	$\frac{\Delta V_{OUT}}{\Delta V_{IN} \cdot V_{OUT}}$	I _{OUT} =40mA V _{IN} =4V to 10V	-	0.2	0.3	%/V
Input Voltage	V _{IN}		-	-	10	V
Output Voltage Temperature Characteristics	$\frac{\Delta V_{OUT}}{\Delta T_{opr} \cdot V_{OUT}}$	I _{OUT} =40mA -40°C ≤ T _{opr} ≤ 85°C	-	±100	-	ppm/°C

G62VP-20 V_{OUT} (T) =2.0V (Note1)

Parameter	Symbol	Condition	Min	TYP	Max	Unit
Output Voltage	V _{OUT(E)} (Note2)	V _{IN} =3.0V, I _{OUT} =40mA	1.960	2.000	2.040	V
Max. Output Current	I _{OUT max}	V _{IN} =3V, V _{OUT(E)} ≥1.8V	100	-	-	mA
Load Stability	ΔV _{OUT}	V _{IN} =3V, I _{OUT} =1mA to 60mA	-	45	90	mV
Input-Output Voltage Differential (Note3)	V _{dif1}	I _{OUT} =60mA	-	180	360	mV
	V _{dif2}	I _{OUT} =120mA	-	400	700	
Supply Current	I _{SS}	V _{IN} =3V	-	2.0	4.5	μA
Input Stability	$\frac{\Delta V_{OUT}}{\Delta V_{IN} \cdot V_{OUT}}$	I _{OUT} =40mA V _{IN} =3V to 10V	-	0.2	0.3	%/V
Input Voltage	V _{IN}		-	-	10	V
Output Voltage Temperature Characteristics	$\frac{\Delta V_{OUT}}{\Delta T_{opr} \cdot V_{OUT}}$	I _{OUT} =40mA -40°C ≤ T _{opr} ≤ 85°C	-	±100	-	ppm/°C

Test Circuit

Circuit1

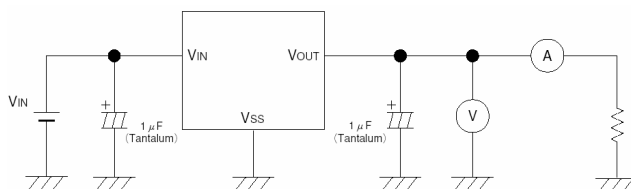

Circuit2

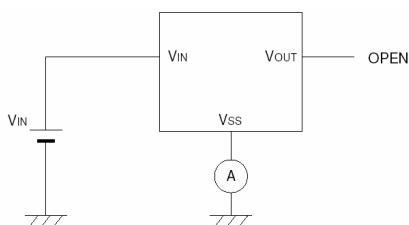

Characteristics Curve

(1) Output Voltage vs. Output Current

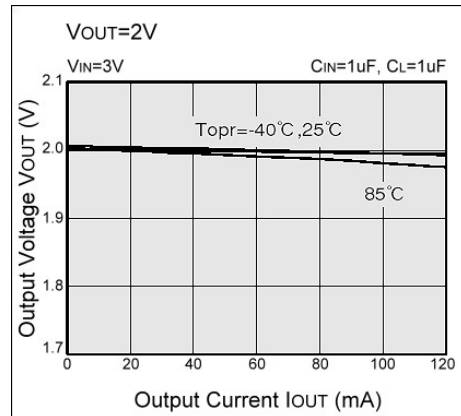
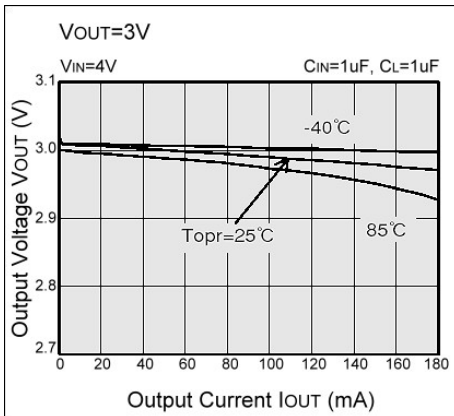
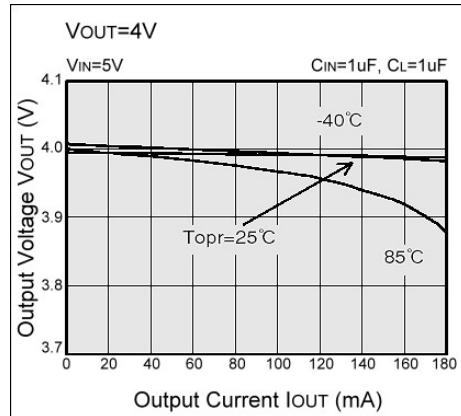
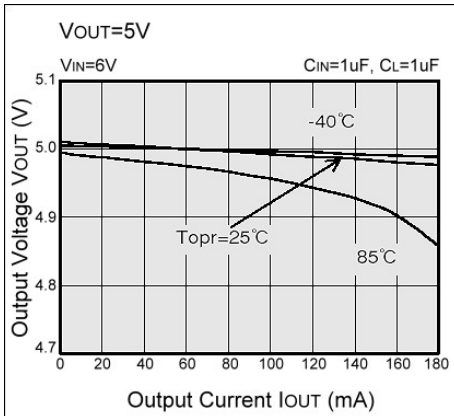

(2) Output Voltage vs. Input Voltage

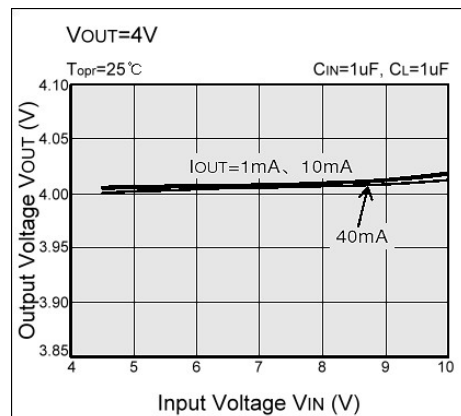
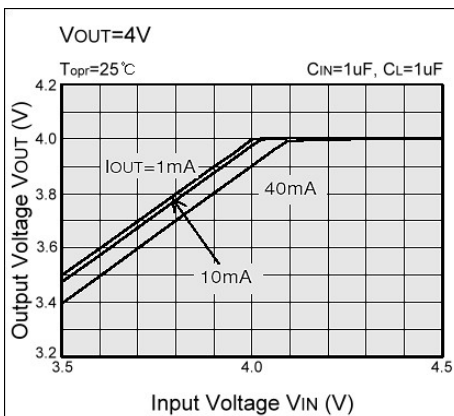
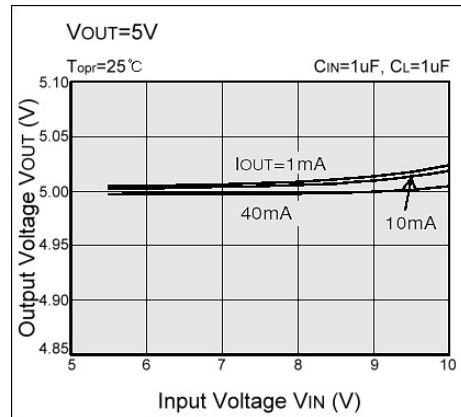
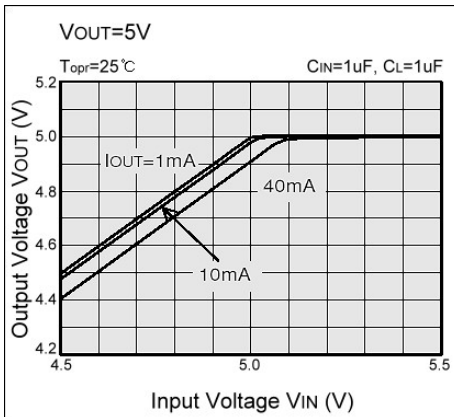

(2) Output Voltage vs. Input Voltage

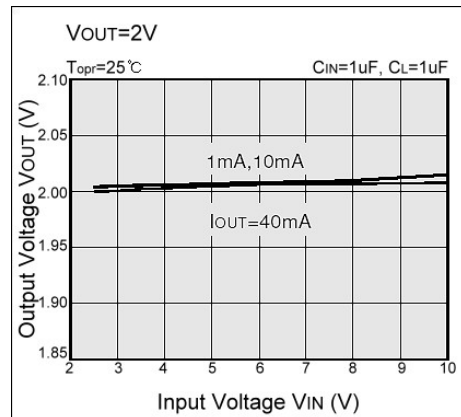
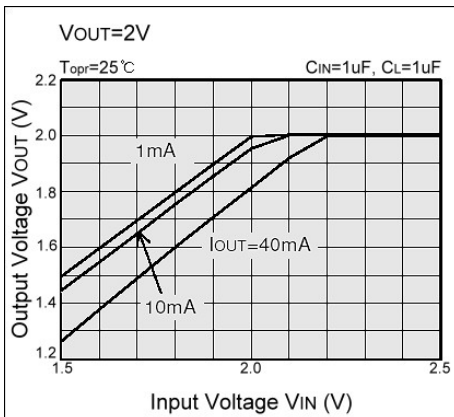
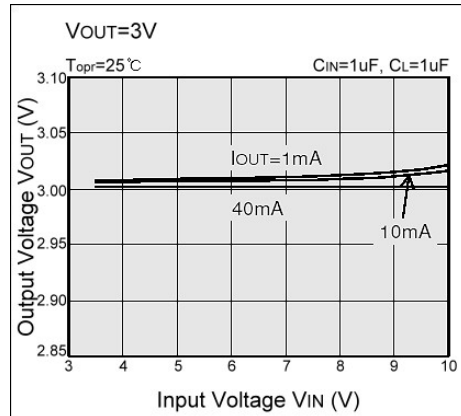
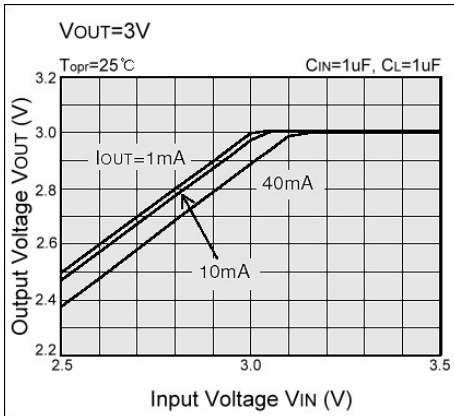

(3) Input/Output Voltage Differential vs. Output Current

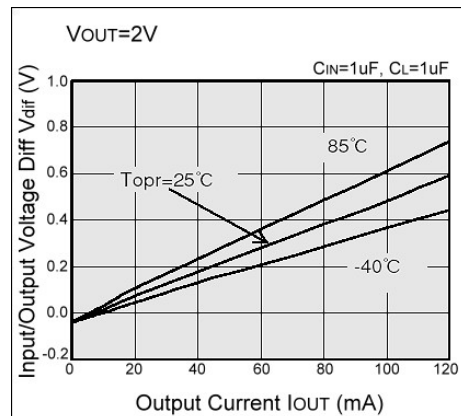
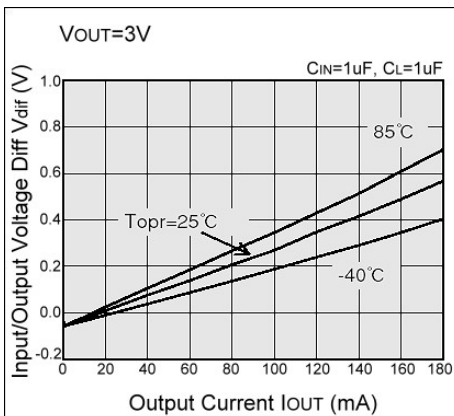
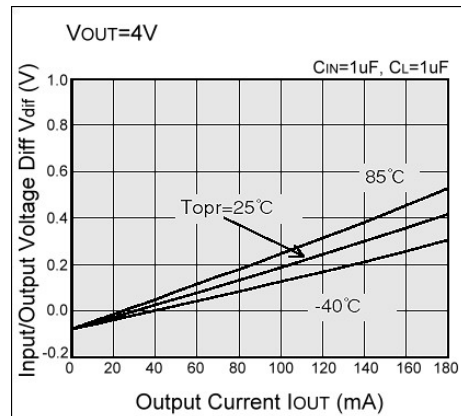
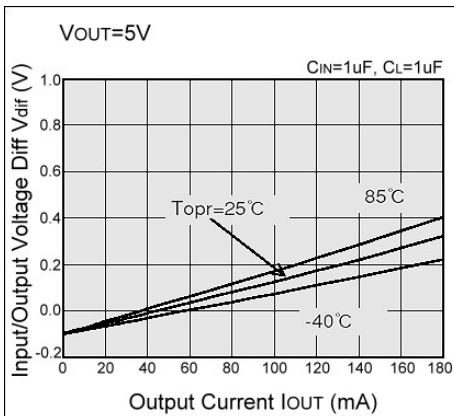

(4) Supply Current vs. Input Voltage

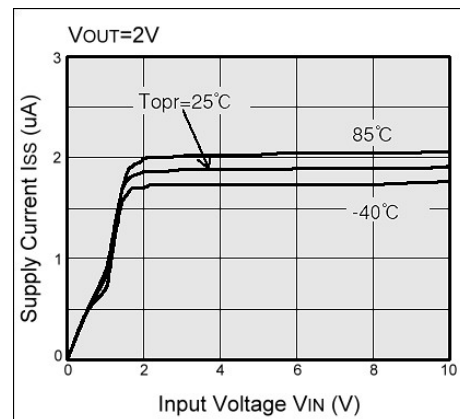
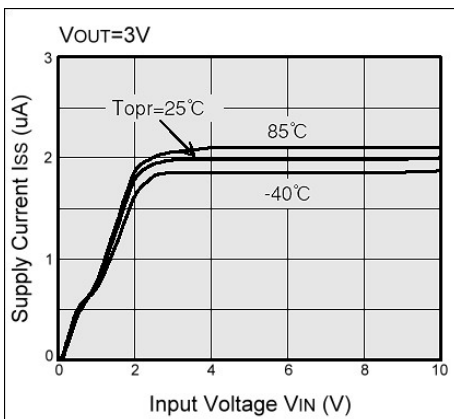
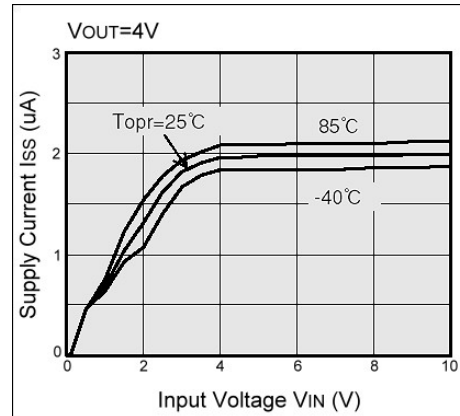
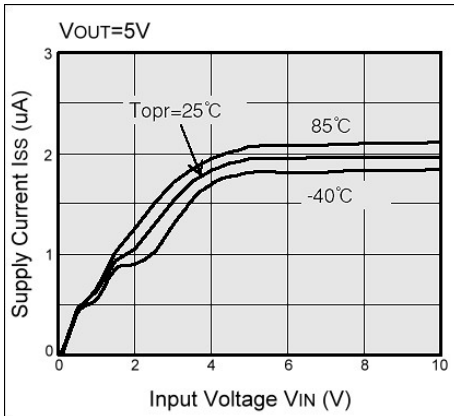

(5) Supply Current vs. Ambient Temperature

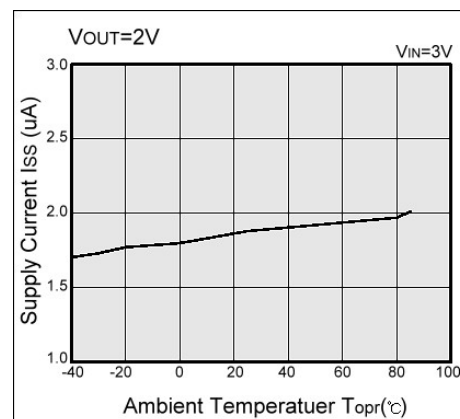
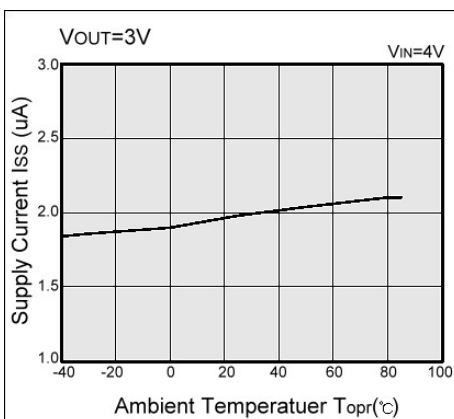
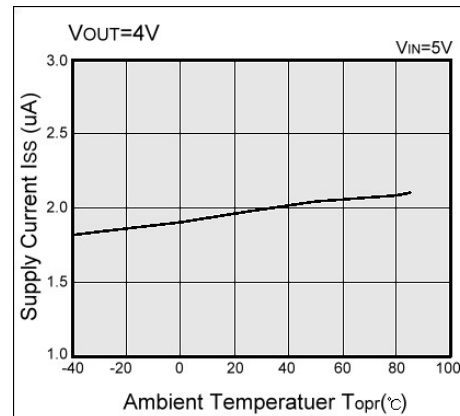
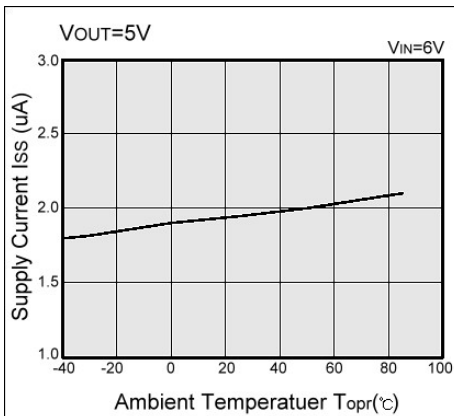

(6) Output Voltage vs. Ambient Temperature

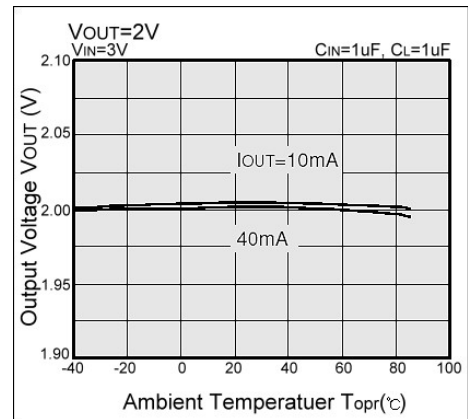
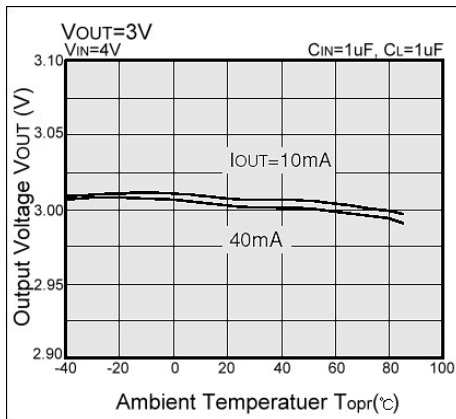
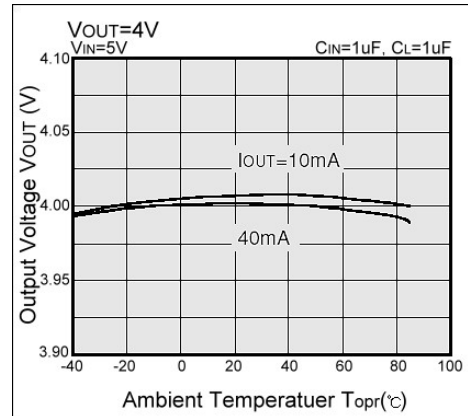
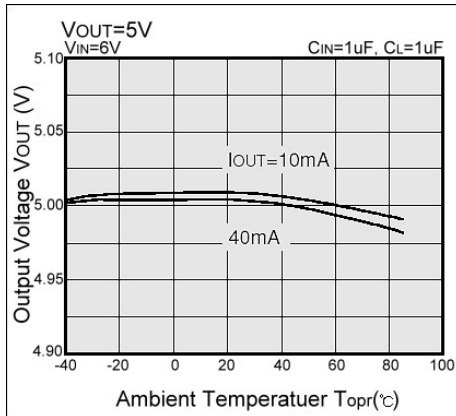

Important Notice:

- All rights are reserved. Reproduction in whole or in part is prohibited without the prior written approval of GTM.
- GTM reserves the right to make changes to its products without notice.
- GTM semiconductor products are not warranted to be suitable for use in life-support Applications, or systems.
- GTM assumes no liability for any consequence of customer product design, infringement of patents, or application assistance.

Head Office And Factory:

- **Taiwan:** No. 17-1 Tatung Rd. Fu Kou Hsin-Chu Industrial Park, Hsin-Chu, Taiwan, R. O. C.
- TEL : 886-3-597-7061 FAX : 886-3-597-9220, 597-0785
- **China:** (201203) No.255, Jang-Jiang Tsai-Lueng RD. , Pu-Dung-Hsin District, Shang-Hai City, China
- TEL : 86-21-5895-7671 ~ 4 FAX : 86-21-38950165