

**5V 1A Low Dropout Regulator with Enable****Features**

- Dropout voltage 0.5V @  $I_o = 1A$
- Output current in excess of 1A
- Output voltage accuracy  $\pm 2.5\%$
- Quiescent current, typically 5mA
- Internal short circuit current limit
- Internal over temperature protection
- ON/OFF control

**General Description**

The G9105 positive 5V voltage regulator features the ability to source 1A of output current. The dropout voltage is 0.5V at 1A output current. The typical quiescent current is 5mA. Furthermore, the quiescent current is smaller when the regulator is in the dropout mode ( $V_{IN} < 5.5V$ ).

Familiar regulator features such as over temperature and over current protection circuits are provided to prevent it from being damaged by abnormal operating conditions. A  $V_{EN}$  pin is provided to disable the output when needed.

**Ordering Information**

ORDER NUMBER	ORDER NUMBER (Pb free)	MARKING	TEMP. RANGE	PACKAGE
G9105TF1T	G9105TF1Tf	G9105	-40°C to +85°C	TO-220F-4
G9105TH1T	G9105TH1Tf	G9105	-40°C to +85°C	TO-220F-4
---	G9105P11U	G9105	-40°C to +85°C	SOP-8

Note: TF :TO220F-4 (short lead) TH :TO220F-4 (long lead) P1: SOP-8

1: Bonding Code

T: Tube U: Tape & Reel

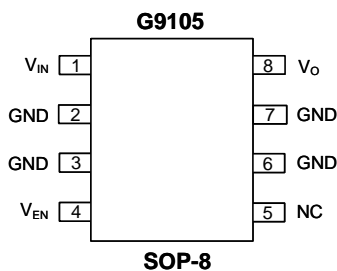
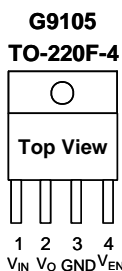
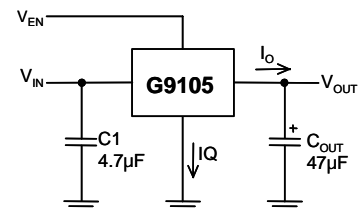
**Package Type****Typical Application**



<b>Absolute Maximum Ratings</b>	(Note 1)
Input Voltage . . . . .	8V
V <sub>EN</sub> Voltage . . . . .	8V
Power Dissipation Internally Limited	(Note 2)
Maximum Junction Temperature . . . . .	150°C
Storage Temperature Range. . . . .	-65°C ≤ T <sub>J</sub> ≤ +150°C
Reflow Temperature (soldering, 10 sec) . . . . .	260°C
Continuous Power Dissipation (T <sub>A</sub> = +25°C)	
TO-220F-4 No Heatsink . . . . .	80°C/W
TO-220F-4 with Infinite Heatsink . . . . .	36°C/W
Thermal Resistance Junction to Ambient, (θ <sub>JA</sub> )	
SOP-8. . . . .	180°C/W

<b>Operating Conditions</b>	(Note 1)
Input Voltage . . . . .	5.5V~7V
Temperature Range. . . . .	-20°C ≤ T <sub>A</sub> ≤ 85°C
V <sub>EN</sub> Voltage . . . . .	V <sub>IN</sub> +0.3V

## Electrical Characteristics

V<sub>IN</sub> = 7V, I<sub>O</sub> = 0.5A, C<sub>IN</sub> = 4.7μF, C<sub>OUT</sub> = 47μF, T<sub>A</sub> = T<sub>J</sub> = 25°C unless otherwise specified [Note 3]

PARAMETER	SYMBOL	CONDITION	MIN	TYP	MAX	UNIT
Output Voltage	V <sub>O</sub>	I <sub>O</sub> = 0.5A	4.875	5	5.125	V
Line Regulation		5.5V ≤ V <sub>IN</sub> ≤ 7V, I <sub>O</sub> = 10mA	---	0.5	2	%
Load Regulation		50mA ≤ I <sub>O</sub> ≤ 1A	---	0.5	2	%
Quiescent Current	I <sub>Q</sub>	V <sub>IN</sub> = 5.5V, V <sub>EN</sub> = V <sub>IN</sub>	---	5	10	mA
		V <sub>IN</sub> = 5.5V, V <sub>EN</sub> = 0V	---	10	30	μA
Ripple Rejection		f <sub>i</sub> = 120Hz, 1VP-P, I <sub>O</sub> = 100mA	---	35	---	dB
Dropout Voltage	V <sub>D</sub>	I <sub>O</sub> = 1A	---	---	0.5	V
Short Circuit Current			---	1.9	---	A
Over Temperature			---	150	---	°C
V <sub>EN</sub> Voltage High	V <sub>ENH</sub>	Output Active	2	---	---	V
V <sub>EN</sub> Voltage Low	V <sub>ENL</sub>	Output Disabled	---	---	0.8	V
V <sub>EN</sub> Bias Current High	I <sub>ENH</sub>	V <sub>EN</sub> = 2.7V	---	---	20	μA
V <sub>EN</sub> Bias Current Low	I <sub>ENL</sub>	V <sub>EN</sub> = 0.4V	---	---	20	μA

**Note 1:** Absolute Maximum Ratings are limits beyond which damage to the device may occur. Operating Conditions are conditions under which the device functions but the specifications might not be guaranteed. For guaranteed specifications and test conditions see the Electrical Characteristics.

**Note2:** The maximum power dissipation is a function of the maximum junction temperature, T<sub>Jmax</sub>; total thermal resistance, θ<sub>JA</sub>, and ambient temperature T<sub>A</sub>. The maximum allowable power dissipation at any ambient temperature is T<sub>Jmax</sub>-T<sub>A</sub>/θ<sub>JA</sub>. If this dissipation is exceeded, the die temperature will rise above 150°C and IC will go into thermal shutdown. For the TO-220F-4 package, θ<sub>JA</sub> is 80°C/W (No heat sink).

**Note3:** Low duty pulse techniques are used during test to maintain junction temperature as close to ambient as possible.

**Note4:** The type of output capacitor should be tantalum or aluminum.

## Definitions

### Dropout Voltage

The input/output Voltage differential at which the regulator output no longer maintains regulation against further reductions in input voltage. Measured when the output drops 2% below its nominal value, dropout voltage is affected by junction temperature, load current and minimum input supply requirements.

### Line Regulation

The change in output voltage for a change in input voltage. The measurement is made under conditions of low dissipation or by using pulse techniques such that average chip temperature is not significantly affected.

### Load Regulation

The change in output voltage for a change in load current at constant chip temperature. The measurement is made under conditions of low dissipation or by using pulse techniques such that average chip temperature is not significantly affected.

### Maximum Power Dissipation

The maximum total device dissipation for which the regulator will operate within specifications.

### Quiescent Bias Current

Current which is used to operate the regulator chip and is not delivered to the load.

**Block Diagram**

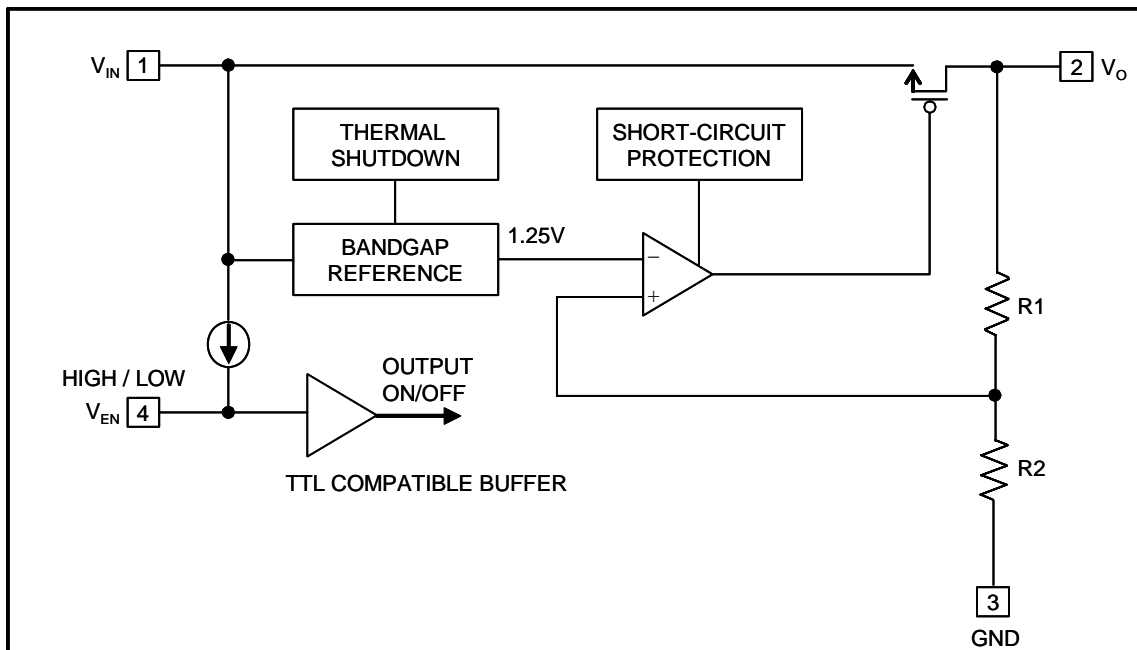

**Typical Performance Characteristics**

( $V_{IN}=5V$ ,  $C_{IN}=10\mu F$ ,  $C_{OUT}=47\mu F$ ,  $T_A=25^\circ C$ , unless otherwise noted.)

**Line Transient Response**

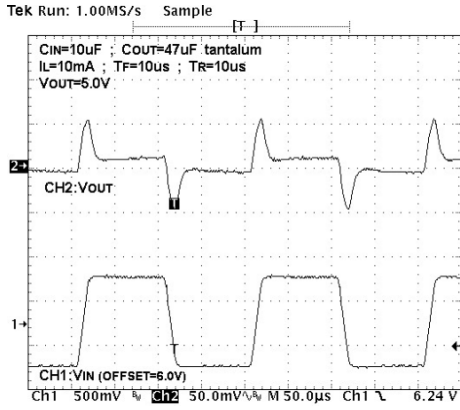

**Load Transient Response**

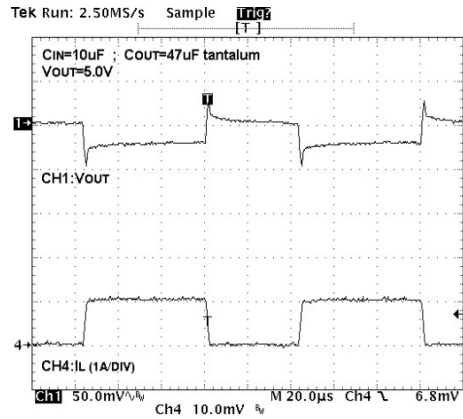

**Short Circuit-Current**

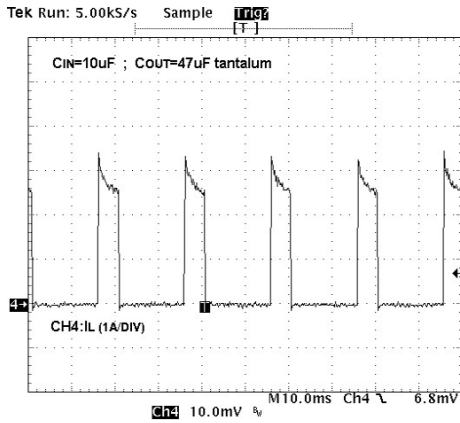

**Output Noise**

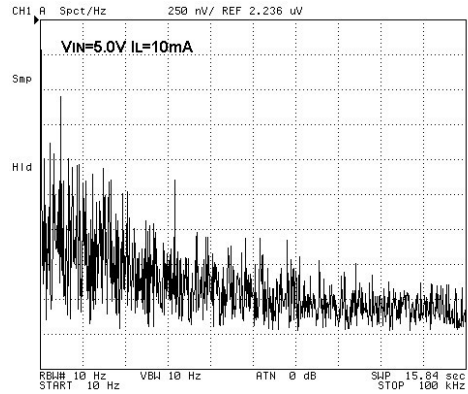

**Ripple Rejection**

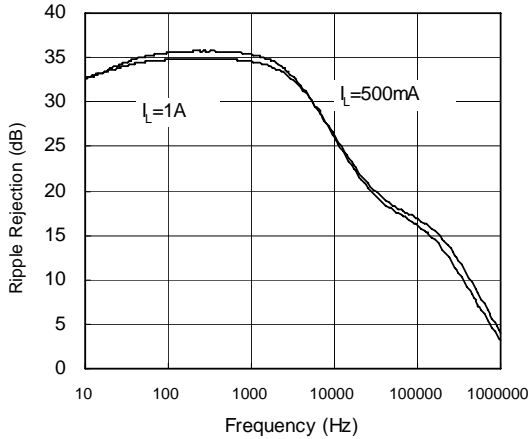

**V<sub>EN</sub>-ON**

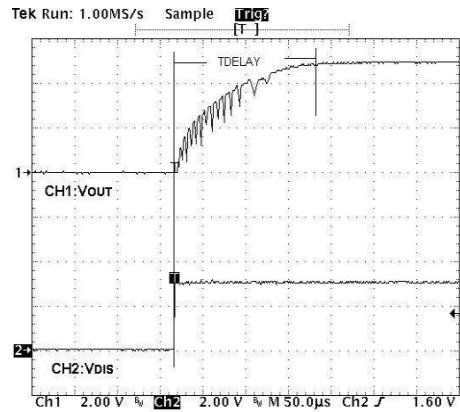



Typical Performance Characteristics (continued)

Dropout Voltage vs. Temperature

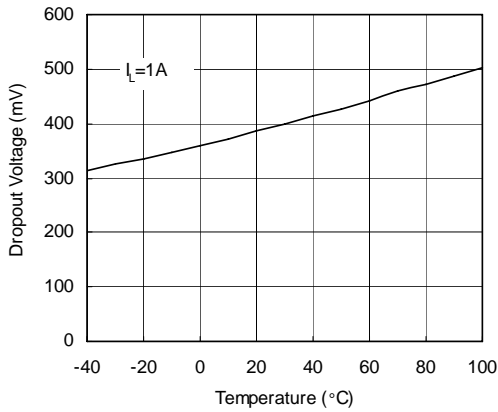

Load Regulation

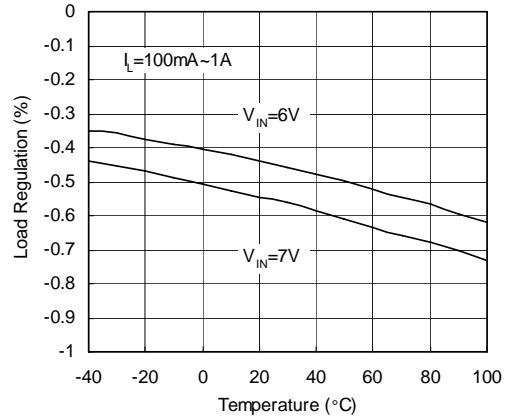

Output Voltage vs. Temperature

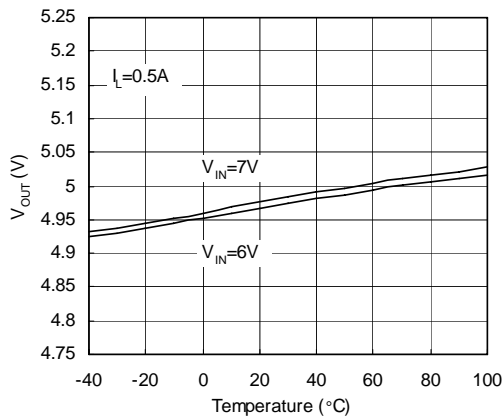

Quiescent Current vs. Temperature

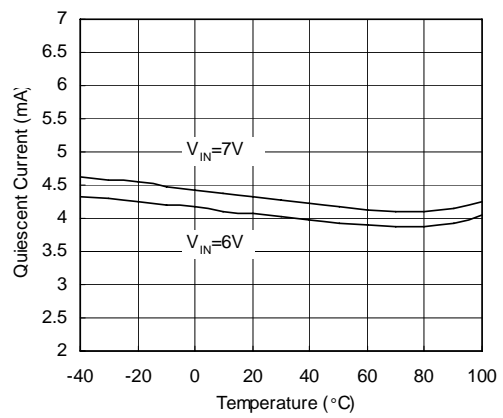

Output Voltage vs. Disable Voltage

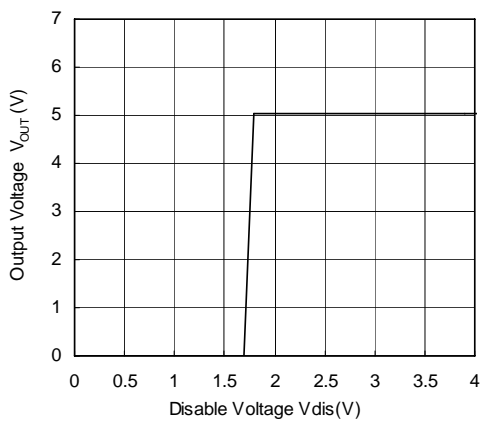

Output Voltage vs. Input Voltage

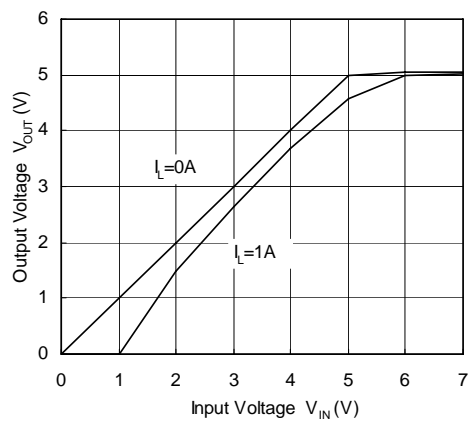

Typical Performance Characteristics (continued)

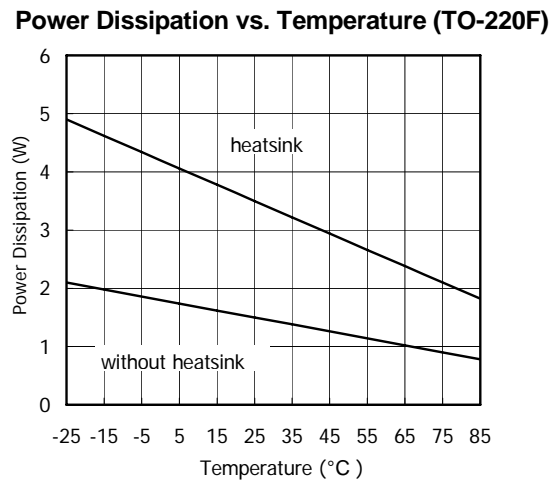
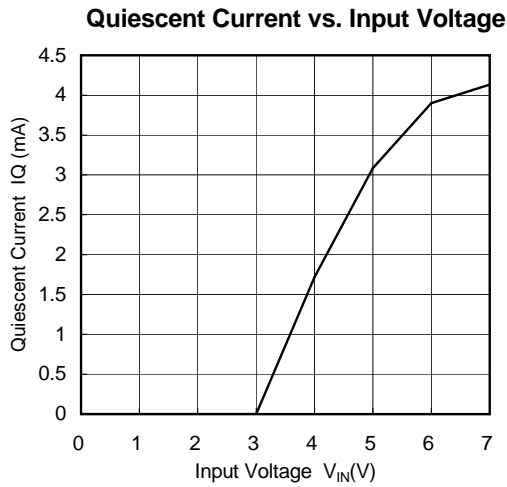

### Recommended Minimum Footprint

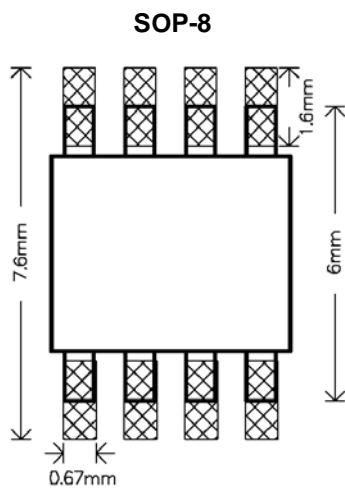

### Heatsink Package Dimension

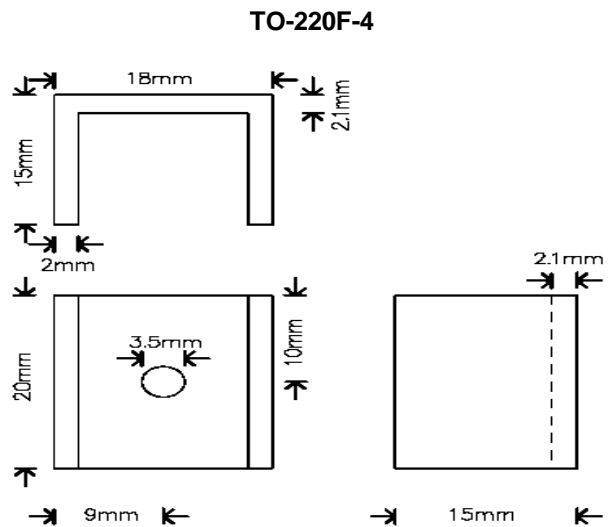

## Package Information

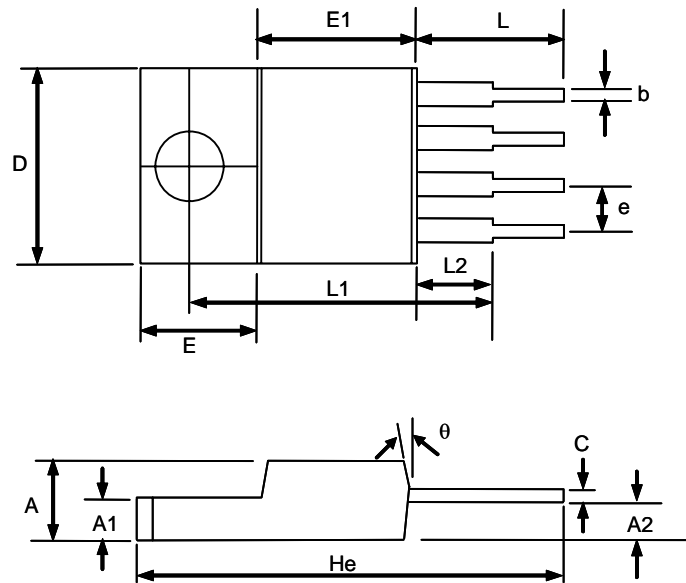

TO-220F-4 Package (short lead)

SYMBOL	DIMENSION IN MM			DIMENSION IN INCH		
	MIN.	NOM.	MAX.	MIN.	NOM.	MAX.
A	4.42	4.57	4.72	0.174	0.180	0.186
A1	2.69	2.79	2.89	0.106	0.110	0.114
A2	1.68	1.78	1.88	0.066	0.070	0.074
D	10.00	10.10	10.20	0.394	0.398	0.402
E	6.85	6.95	7.05	0.269	0.273	0.278
E1	8.54	8.64	8.74	0.336	0.340	0.344
L	7.15	7.35	7.55	0.281	0.289	0.297
L1	16.56	16.66	16.76	0.652	0.656	0.660
L2	3.60	3.70	3.80	0.142	0.146	0.150
He	22.54	22.94	23.34	0.887	0.903	0.919
C	-----	0.48	-----	-----	0.019	-----
e	-----	2.54(TYP)	-----	-----	0.1(TYP)	-----
b	-----	0.635(TYP)	-----	-----	0.025(TYP)	-----
$\theta$	4°	7°	11°	4°	7°	11°

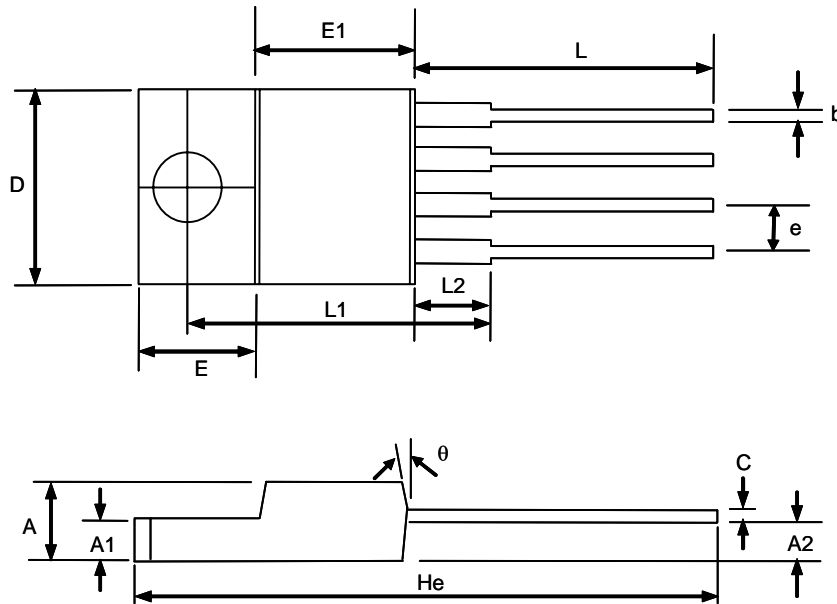

TO-220F-4 Package (long lead)

SYMBOL	DIMENSION IN MM			DIMENSION IN INCH		
	MIN.	NOM.	MAX.	MIN.	NOM.	MAX.
A	4.42	4.57	4.72	0.174	0.180	0.186
A1	2.69	2.79	2.89	0.106	0.110	0.114
A2	1.68	1.78	1.88	0.066	0.070	0.074
D	10.00	10.10	10.20	0.394	0.398	0.402
E	6.85	6.95	7.05	0.269	0.273	0.278
E1	8.54	8.64	8.74	0.336	0.340	0.344
L	13.15	13.35	13.55	0.518	0.526	0.533
L1	16.56	16.66	16.76	0.652	0.656	0.660
L2	3.60	3.70	3.80	0.142	0.146	0.150
He	28.44	28.94	29.44	1.119	1.139	1.159
C	-----	0.48	-----	-----	0.019	-----
e	-----	2.54(TYP)	-----	-----	0.1(TYP)	-----
b	-----	0.635(TYP)	-----	-----	0.025(TYP)	-----
$\theta$	4°	7°	11°	4°	7°	11°



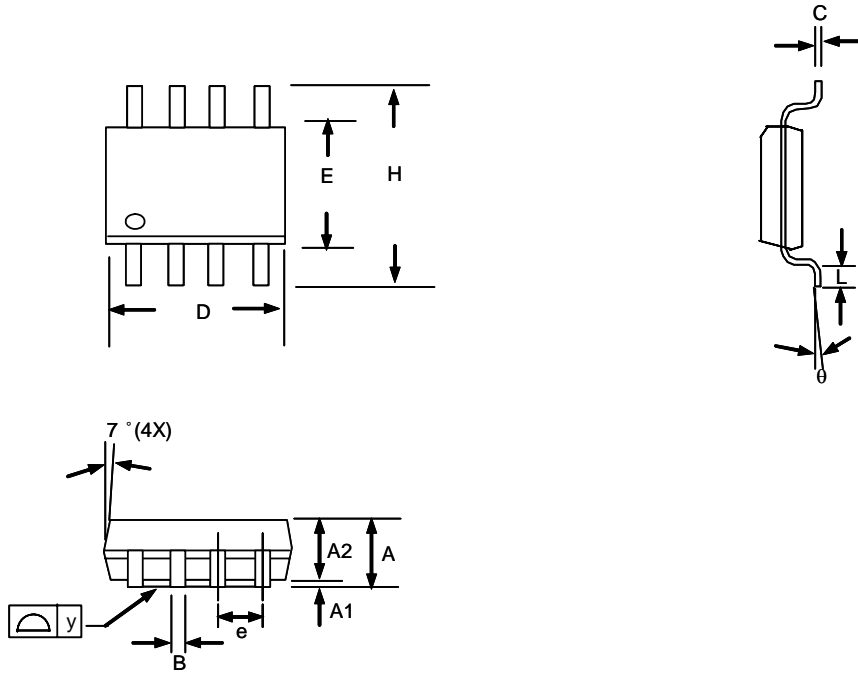

**SOP-8 Package**

**Note:**

1. Package body sizes exclude mold flash and gate burrs
2. Dimension L is measured in gage plane
3. Tolerance 0.10mm unless otherwise specified
4. Controlling dimension is millimeter converted inch dimensions are not necessarily exact.

SYMBOL	DIMENSION IN MM			DIMENSION IN INCH		
	MIN.	NOM.	MAX.	MIN.	NOM.	MAX.
A	1.35	1.60	1.75	0.053	0.063	0.069
A1	0.10	-----	0.25	0.004	-----	0.010
A2	-----	1.45	-----	-----	0.057	-----
B	0.33	-----	0.51	0.013	-----	0.020
C	0.19	-----	0.25	0.007	-----	0.010
D	4.80	-----	5.00	0.189	-----	0.197
E	3.80	-----	4.00	0.150	-----	0.157
e	-----	1.27	-----	-----	0.050	-----
H	5.80	-----	6.20	0.228	-----	0.244
L	0.40	-----	1.27	0.016	-----	0.050
y	-----	-----	0.10	-----	-----	0.004
$\theta$	0°	-----	8°	0°	-----	8°

**Taping Specification**

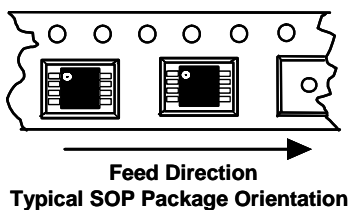

PACKAGE	Q'TY/BY TUBE	Q'TY/REEL
TO-220F-4	50 ea	---
SOP-8	---	2,500 ea

GMT Inc. does not assume any responsibility for use of any circuitry described, no circuit patent licenses are implied and GMT Inc. reserves the right at any time without notice to change said circuitry and specifications.