

2.5V 1A Regulator

Features

- Output current in excess of 1A
- Output voltage accuracy +3%/-1%
- Quiescent current, typically 600μA
- Internal short circuit current limit
- Internal over temperature protection

Applications

- PC motherboard
- ADSL/Cable Modem
- Set-Top-Box
- LAN switch/Hub
- Router

General Description

The G950 positive 2.5V voltage regulator features the ability to source 1A of output current. The typical quiescent current is 0.6mA.

Familiar regulator features such as over temperature and over current protection circuits are provided to prevent it from being damaged by abnormal operating conditions.

Ordering Information

ORDER NUMBER	PACKAGE TYPE	PIN OPTION		
		1	2	3
G950T45U	TO 252	V _{IN}	GND	V _{OUT}
G950T55U	TO 263	V _{IN}	GND	V _{OUT}
G950T63U	SOT 223	GND	V _{OUT}	V _{IN}
G950T64U	SOT 223	GND	V _{IN}	V _{OUT}
G950T65U	SOT 223	V _{IN}	GND	V _{OUT}
G950T66U	SOT 223	V _{IN}	V _{OUT}	GND

* For other package types and pin options, please contact us at sales @gmt.com.tw

Order Number Identification

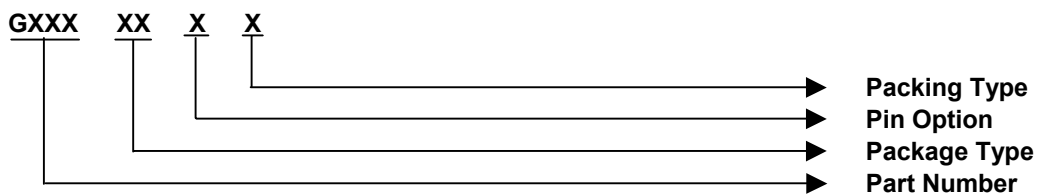

PACKAGE TYPE

- T3 : TO 220
- T4 : TO 252
- T5 : TO 263
- T6 : SOT 223

PIN OPTION

	1	2	3
1 :	V _{OUT}	GND	V _{IN}
2 :	V _{OUT}	V _{IN}	GND
3 :	GND	V _{OUT}	V _{IN}
4 :	GND	V _{IN}	V _{OUT}
5 :	V _{IN}	GND	V _{OUT}
6 :	V _{IN}	V _{OUT}	GND

PACKING

- U & D : Tape & Reel Direction
- T : Tube

Typical Application

[Note 4] : Type of C_{OUT}

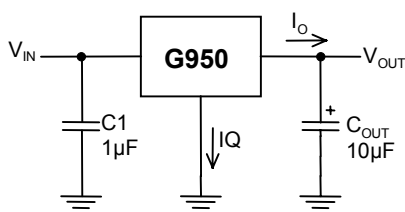

Package Type

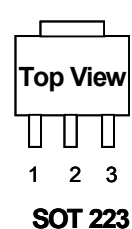
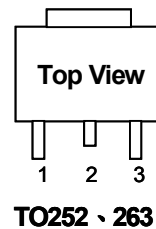
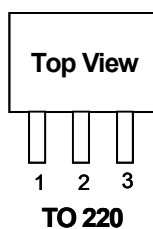

**Absolute Maximum Ratings** (Note 1)

Input Voltage.....	7V
Power Dissipation Internally Limited	(Note 2)
Maximum Junction Temperature.....	150°C
Storage Temperature Range.....	-65°C ≤ T _J ≤ +150°C
Lead Temperature, Time for Wave Soldering	
TO 220 Package.....	260°C, 10s
TO 252, TO 263, SOT 223 Package.....	260°C, 4s
Continuous Power Dissipation (T _A = + 25°C)	
SOT 223 ⁽¹⁾	0.8W
TO 252 ⁽¹⁾	1.0W
TO 263 ⁽¹⁾	1.6W

Note ⁽¹⁾: See Recommended Minimum Footprint.

Operating Conditions (Note 1)

Input Voltage.....	3.3V~6V
Temperature Range.....	0°C ≤ T _J ≤ 125°C

Electrical Characteristics

V_{IN} = 5V, I_O = 1A, C_{IN} = 1μF, C_{OUT} = 10 μF, All specifications apply for T_A = T_J = 25°C. [Note 3]

PARAMETER	CONDITIONS	MIN	TYP	MAX	UNITS
Output Voltage	V _{IN} = 5V, 10mA ≤ I _O ≤ 1A	2.475	2.50	2.575	V
	V _{IN} = 3.3V, 10mA ≤ I _O ≤ 500mA				
Line Regulation	3.3V ≤ V _{IN} ≤ 6V, I _O = 10mA		3	30	mV
Load Regulation	V _{IN} = 5V, 10mA ≤ I _O ≤ 1A		35	50	mV
	V _{IN} = 3.3V, 10mA ≤ I _O ≤ 500mA		25		mV
Output Impedance	200mA DC and 100mA AC, f _o = 120Hz		80		mΩ
Quiescent Current	V _{IN} = 5V		0.6		mA
Ripple Rejection	f _i = 120Hz, V _{ripple} = 2V _{P-P} , I _O = 100mA		46		dB
Dropout Voltage	I _O = 1A		1.15		V
	I _O = 500mA		420		mV
	I _O = 100mA		200		mV
Short Circuit Current			1.6		A
Over Temperature			150		°C

Note 1: Absolute Maximum Ratings are limits beyond which damage to the device may occur. Operating Conditions are conditions under which the device functions but the specifications might not be guaranteed. For guaranteed specifications and test conditions see the Electrical Characteristics.

Note2: The maximum power dissipation is a function of the maximum junction temperature, T_{Jmax}; total thermal resistance, θ_{JA}, and ambient temperature T_A. The maximum allowable power dissipation at any ambient temperature is T_{Jmax}-T_A/θ_{JA}. If this dissipation is exceeded, the die temperature will rise above 150°C and IC will go into thermal shutdown. For the G950 in SOT 223 package, θ_{JA} is 156°C/W; in TO 263 package, θ_{JA} is 75°C/W, and in the TO 252 package, θ_{JA} is 125°C/W (See recommend minimum footprint). The safe operation in SOT 223, TO 252 & TO 263 package, it can see "Typical Performance Characteristics" (Safe Operating Area).

Note3: Low duty pulse techniques are used during test to maintain junction temperature as close to ambient as possible.

Note4: The type of output capacitor should be tantalum or aluminum.

Definitions**Dropout Voltage**

The input/output Voltage differential at which the regulator output no longer maintains regulation against further reductions in input voltage. Measured when the output drops 100mV below its nominal value. Dropout voltage is affected by junction temperature, load current and minimum input supply requirements.

Line Regulation

The change in output voltage for a change in input voltage. The measurement is made under conditions of low dissipation or by using pulse techniques such that average chip temperature is not significantly affected.

Load Regulation

The change in output voltage for a change in load current at constant chip temperature. The measurement is made under conditions of low dissipation or by using pulse techniques such that average chip temperature is not significantly affected.

Maximum Power Dissipation

The maximum total device dissipation for which the regulator will operate within specifications.

Quiescent Bias Current

Current which is used to operate the regulator chip and is not delivered to the load.



Typical Performance Characteristics

($V_{IN} = +5V$, $C_{IN} = 1\mu F$, $C_{OUT} = 10\mu F$, $T_A = 25^\circ C$, unless otherwise noted.)

Line Transient

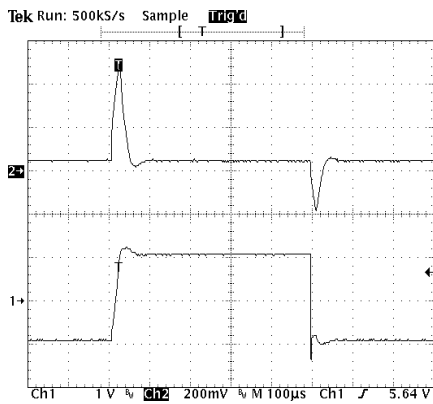

Ch1: Vin (offset=5.0V)
 Ch2: Vout (offset=2.50V)
 $C_{IN} = 1\mu F$
 $I_{out} = 100mA$

Load Transient

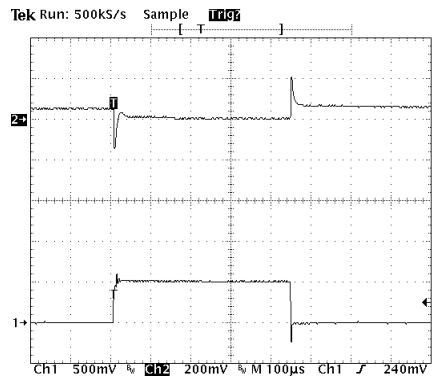

Ch1: I_{out} (1A/div)
 Ch2: Vout (offset=2.50V)

Output Voltage vs. Load Current

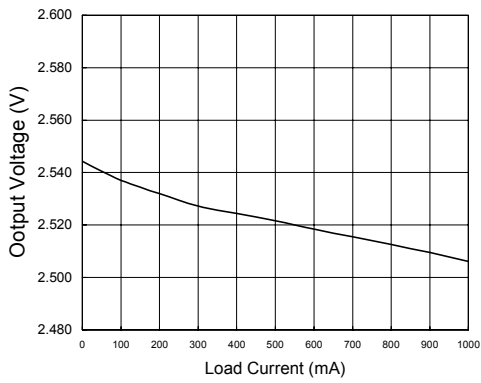

Dropout Voltage vs. Load Current

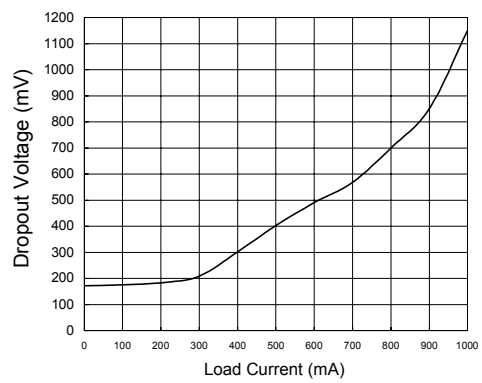

Ground Current vs. Load Current

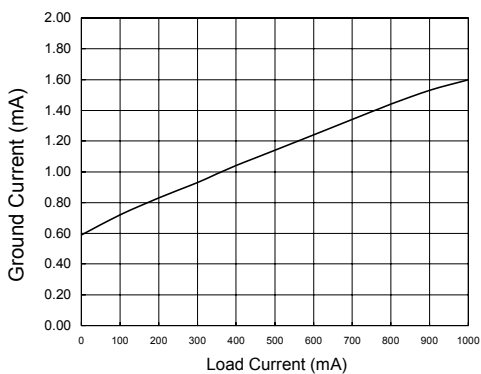



Typical Performance Characteristics

($V_{IN} = +3.3V$, $C_{IN} = 1\mu F$, $C_{OUT} = 10\mu F$, $T_A = 25^\circ C$, unless otherwise noted.)

Line Transient

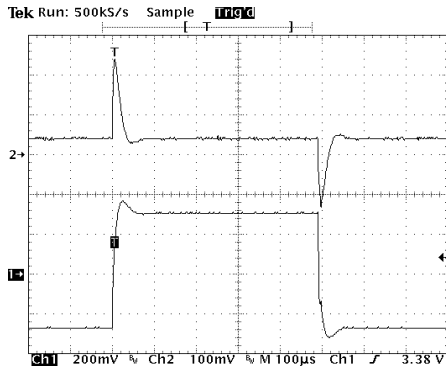

Ch1: V_{in} (offset=3.3V)
 Ch2: V_{out} (offset=2.50V)
 $C_{IN} = 1\mu F$
 $I_{out} = 100mA$

Load Transient

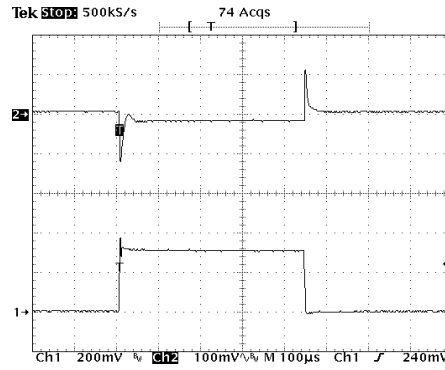

Ch1: I_{out} (400mA/div)
 Ch2: V_{out} is AC coupled

Output Voltage vs. Load Current

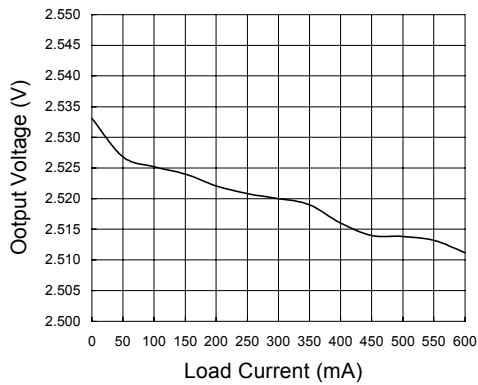

Dropout Voltage vs. Load Current

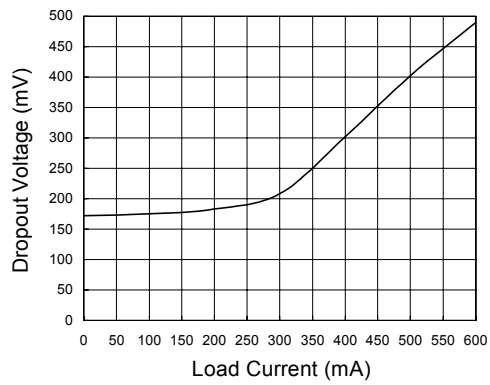

Ground Current vs. Load Current

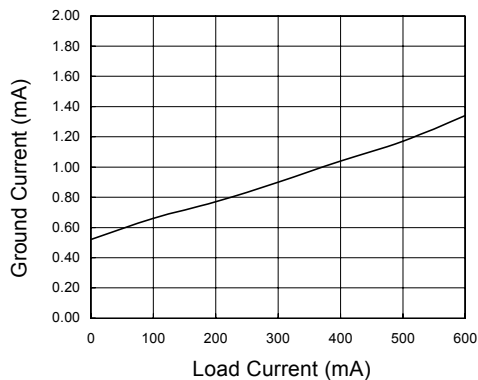

Safe Operating Area of SOT-223

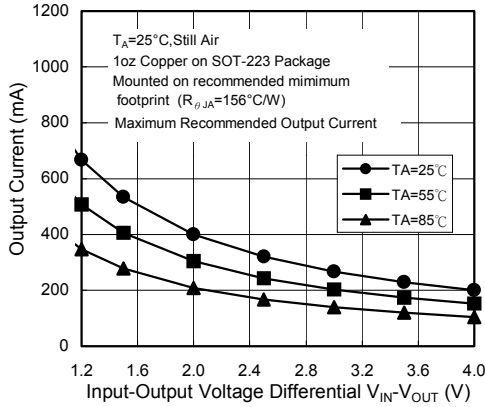

Note: $V_{IN(max)} \leq 6.5V$

Power Dissipation of SOT-223

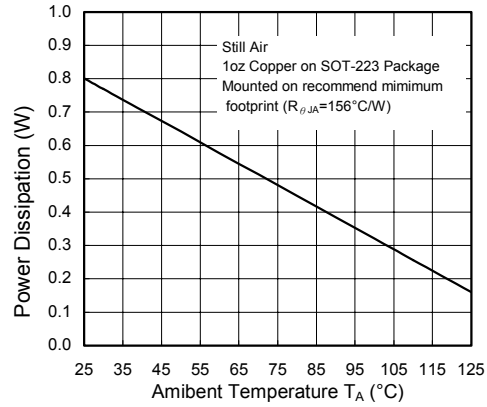

Safe Operating Area of TO-252

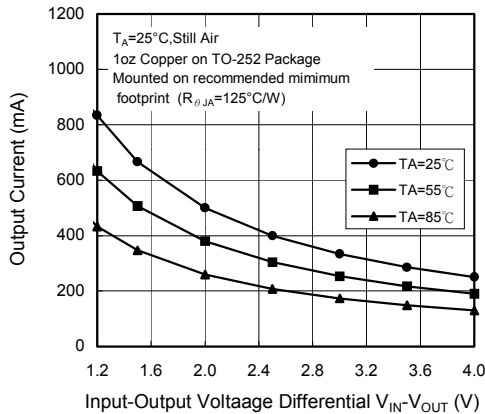

Note: $V_{IN(max)} \leq 6.5V$

Power Dissipation of TO-252

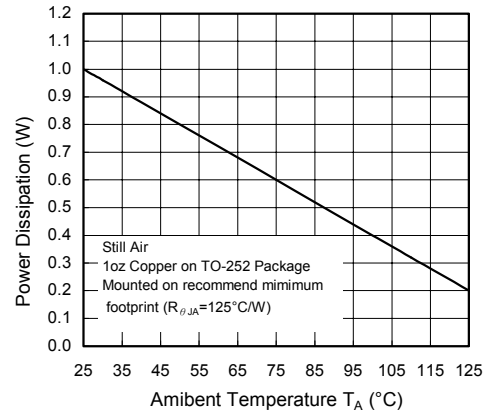

Safe Operating Area of TO-263

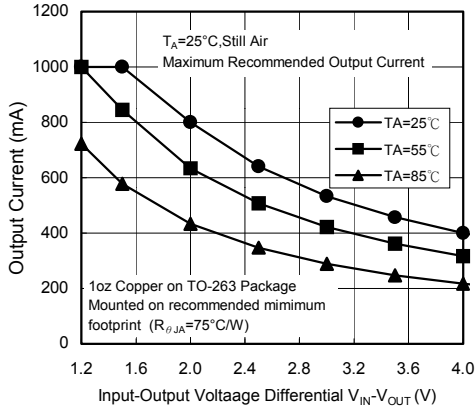

Note: $V_{IN(max)} \leq 6.5V$

Power Dissipation of TO-263

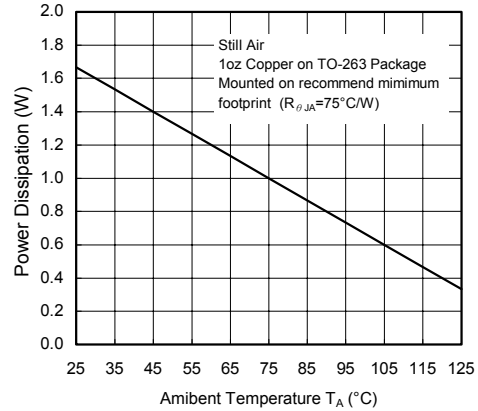

Recommend Minimum Footprint

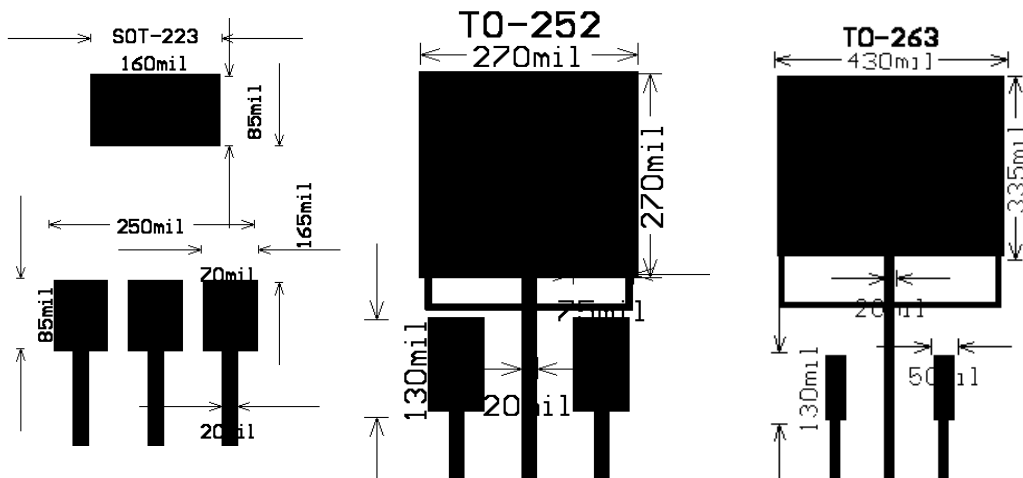

Package Information

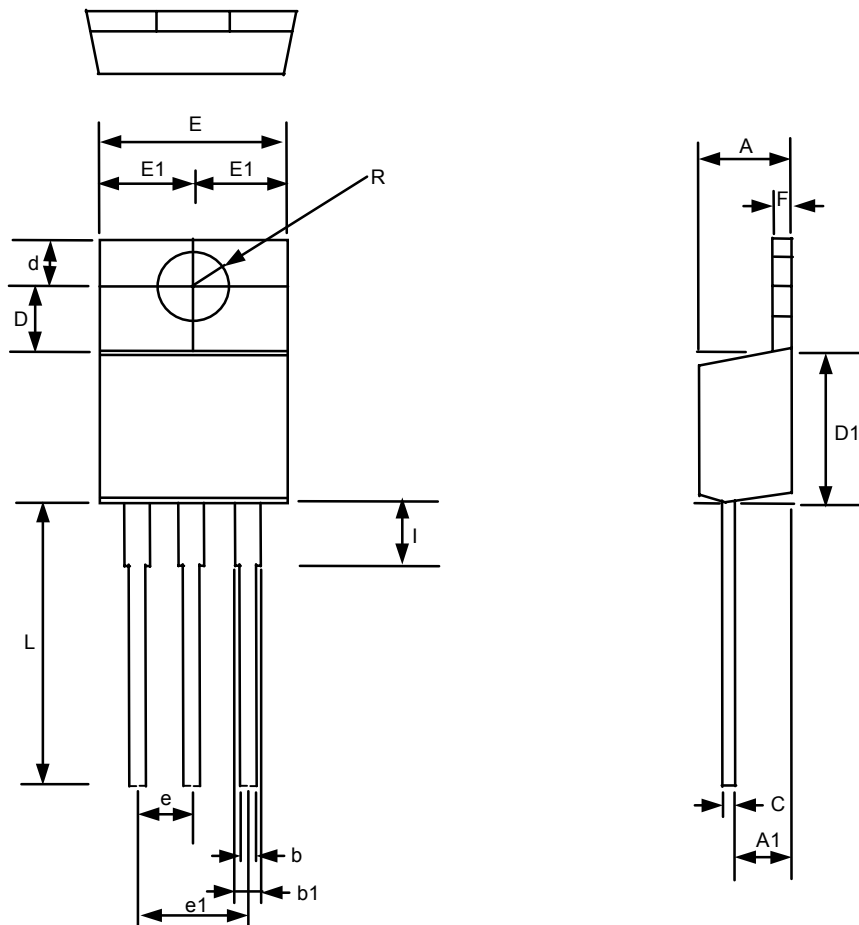

TO-220 (T3) Package

SYMBOLS	MILLIMETERS		INCHES	
	MIN	MAX	MIN	MAX
A	4.318	4.826	0.170	0.190
A1	2.46	2.72	0.097	0.107
b	0.69	0.94	0.027	0.037
b1	1.143	1.397	0.045	0.055
C	0.304	0.460	0.012	0.018
D	3.429	3.683	0.135	0.145
D1	8.53	9.04	0.336	0.356
d	2.62	2.87	0.103	0.113
E	9.906	10.40	0.390	0.410
E1	2.84	5.13	0.112	0.202
e	2.29	2.79	0.090	0.110
e1	4.83	5.33	0.190	0.210
F	1.143	1.397	0.045	0.055
I	3.454	3.962	0.136	0.156
L	13.589	14.351	0.535	0.565

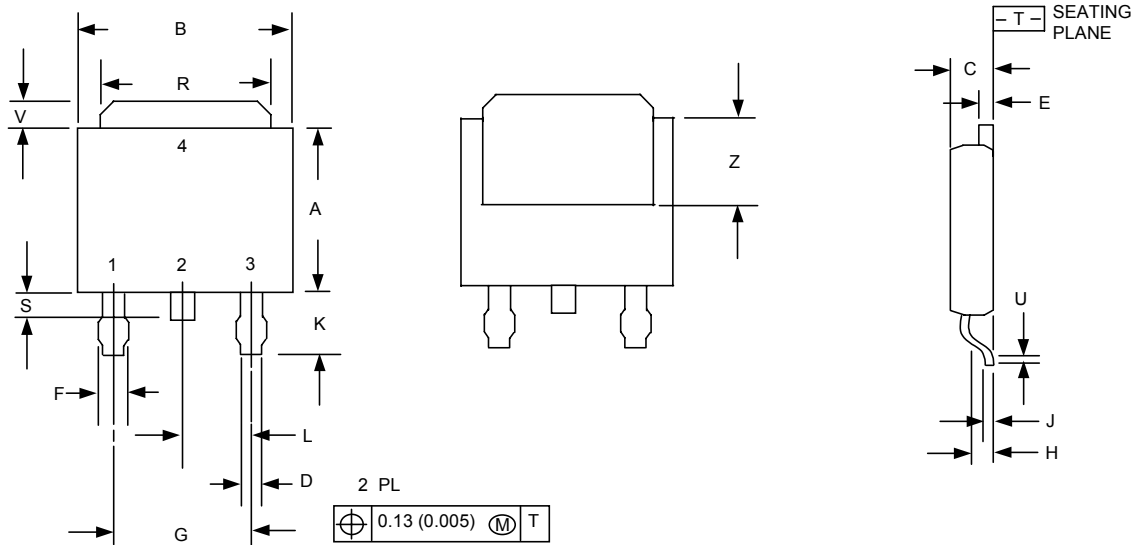

TO-252 (T4) Package

Notes:

1. Dimensioning and tolerancing per ansi y14.5m, 1982.
2. Controlling dimension : inch

DIM	INCHES		MILLIMETERS	
	MIN	MAX	MIN	MAX
A	0.235	0.250	5.97	6.35
B	0.250	0.265	6.35	6.73
C	0.086	0.094	2.19	2.38
D	0.027	0.035	0.69	0.88
E	0.033	0.040	0.84	1.01
F	0.037	0.047	0.94	1.19
G	0.180BSC		4.58BSC	
H	0.034	0.040	0.87	1.01
J	0.018	0.023	0.46	0.58
K	0.102	0.114	2.60	2.89
L	0.090BSC		2.29BSC	
R	0.175	0.215	4.45	6.46
S	0.020	0.050	0.51	1.27
U	0.020	---	0.51	---
V	0.030	0.050	0.77	1.27
Z	0.138	---	3.51	---

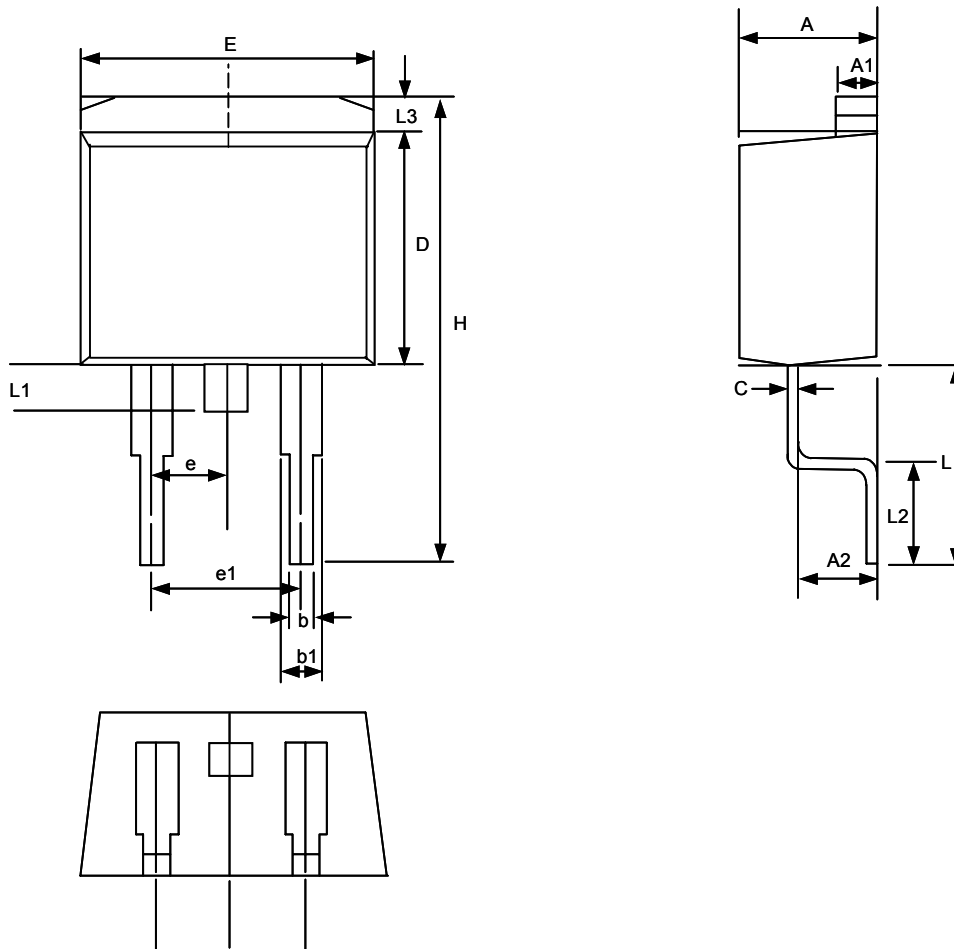

TO-263 (T5) Package

SYMBOLS	MILLIMETERS		INCHES	
	MIN	MAX	MIN	MAX
A	4.30	4.70	0.169	0.185
A1	1.22	1.32	0.048	0.055
A2	2.45	2.69	0.104	0.106
b	0.69	0.94	0.027	0.037
b1	1.22	1.40	0.048	0.055
C	0.36	0.56	0.014	0.022
D	8.64	9.652	0.340	0.380
E	9.70	10.54	0.382	0.415
e	2.29	2.79	0.090	0.110
e1	4.83	5.33	0.190	0.210
H	14.60	15.78	0.575	0.625
L	4.70	5.84	0.185	0.230
L1	1.20	1.778	0.047	0.070
L2	2.24	2.84	0.088	0.111
L3	1.40MAX		0.055MAX	

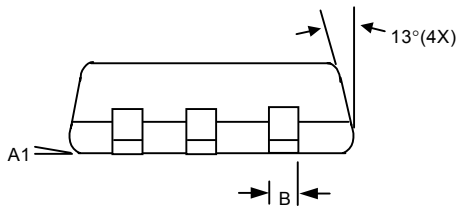
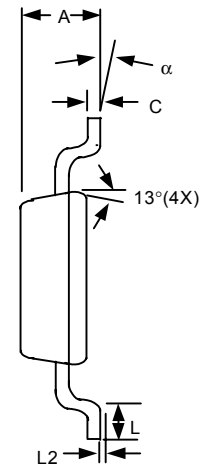
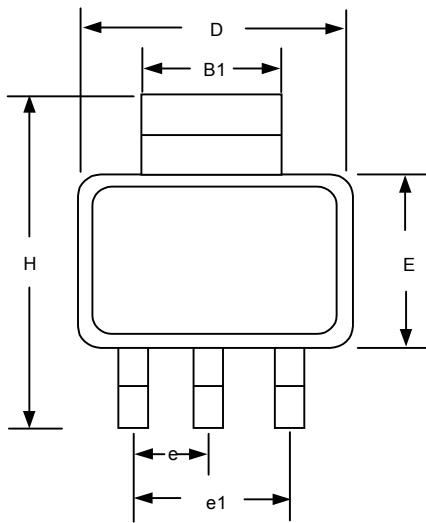

SOT-223 (T6) Package

SYMBOLS	MILLIMETERS		INCHES	
	MIN	MAX	MIN	MAX
A	1.55	1.80	0.061	0.071
A1	0.02	0.12	0.0008	0.0047
B	0.60	0.80	0.024	0.031
B1	2.90	3.10	0.114	0.122
C	0.24	0.32	0.009	0.013
D	6.30	6.70	0.248	0.264
E	3.30	3.70	0.130	0.146
e	2.30 BSC		0.090 BSC	
e1	4.60 BSC		0.181 BSC	
H	6.70	7.30	0.264	0.287
L	0.90 MIN		0.036 MIN	
L2	0.06 BSC		0.0024 BSC	
α	0°	10°	0°	10°

Package Orientation

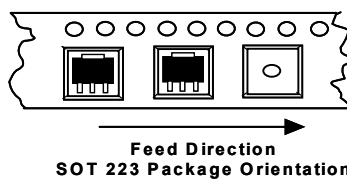
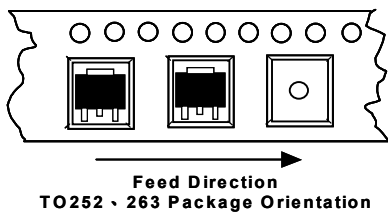

GMT Inc. does not assume any responsibility for use of any circuitry described, no circuit patent licenses are implied and GMT Inc. reserves the right at any time without notice to change said circuitry and specifications.