



STGB10NC60KD STGF10NC60KD - STGP10NC60KD

N-channel 600V - 10A - D²PAK / TO-220 / TO-220FP
Short circuit rated PowerMESH™ IGBT

General features

Type	V _{CE(S)}	V _{CE(sat)} Max @25°C	I _C @100°C
STGB10NC60KD	600V	<2.5V	10A
STGP10NC60KD	600V	<2.5V	10A
STGF10NC60KD	600V	<2.5V	6A

- Lower on voltage drop (V_{cesat})
- Lower C_{RES} / C_{IES} ratio (no cross-conduction susceptibility)
- Very soft ultra fast recovery antiparallel diode
- Short circuit withstand time 10μs

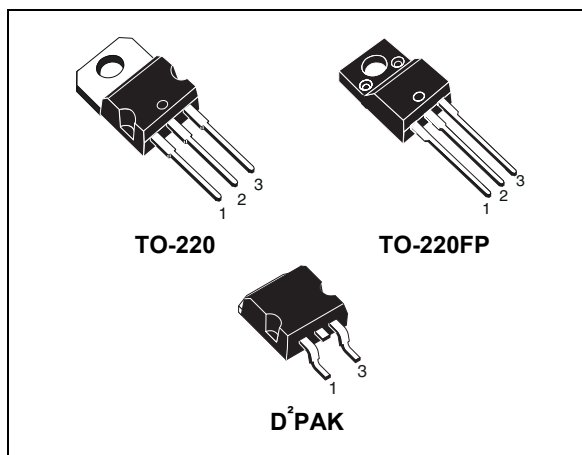

Description

Using the latest high voltage technology based on a patented strip layout, STMicroelectronics has designed an advanced family of IGBTs, the PowerMESH™ IGBTs, with outstanding performances. The suffix “K” identifies a family optimized for high frequency motor control applications with short circuit withstand capability.

Applications

- High frequency motor controls
- SMPS and PFC in both hard switch and resonant topologies
- Motor drivers

Internal schematic diagram

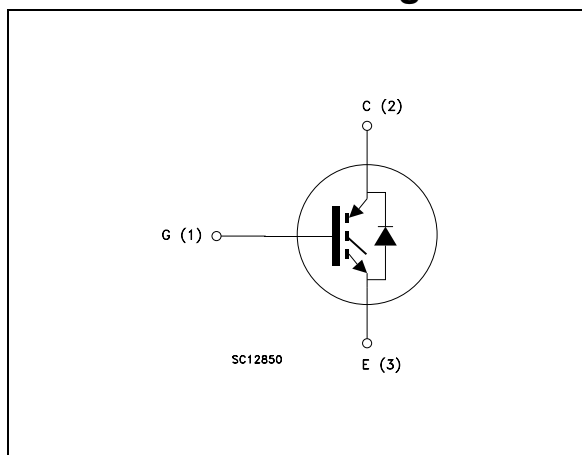

Order codes

Part number	Marking	Package	Packaging
STGB10NC60KDT4	GB10NC60KD	D ² PAK	Tape & reel
STGP10NC60KD	GP10NC60KD	TO-220	Tube
STGF10NC60KD	GF10NC60KD	TO-220FP	Tube

Contents

1	Electrical ratings	3
2	Electrical characteristics	5
	2.1 Electrical characteristics (curves)	7
3	Test circuit	10
4	Package mechanical data	11
5	Packaging mechanical data	15
6	Revision history	16

1 Electrical ratings

Table 1. Absolute maximum ratings

Symbol	Parameter	Value		Unit
		D ² PAK/TO-220	TO-220FP	
V _{CES}	Collector-emitter voltage (V _{GS} = 0)	600		V
I _C ⁽¹⁾	Collector current (continuous) at T _C = 25°C	20	9	A
I _C ⁽¹⁾	Collector current (continuous) at T _C = 100°C	10	6	A
I _{CM} ⁽²⁾	Collector current (pulsed)	30		A
V _{GE}	Gate-emitter voltage	±20		V
I _F	Diode RMS forward current at T _C =25°C	10		A
P _{TOT}	Total dissipation at T _C = 25°C	60	25	W
V _{ISO}	Insulation withstand voltage (RMS) from all three leads to external heat sink (t=1s; T _C =25°C)	--	2500	
T _{stg}	Storage temperature	- 55 to 150		°C
T _j	Operating junction temperature			
T _{scw}	Short circuit withstand time	10		µs
T _l	Maximum lead temperature for soldering purpose (for 10sec. 1.6 mm from case)	300		°C

1. Calculated according to the iterative formula:

$$I_C(T_C) = \frac{T_{JMAX} - T_C}{R_{THJ-C} \times V_{CESAT(MAX)}(T_C, I_C)}$$

2. Pulse width limited by max junction temperature

Table 2. Thermal resistance

Symbol	Parameter		Value	Unit
R _{thj-case}	Thermal resistance junction-case Max	TO-220/D ² PAK	2.08	°C/W
		TO-220FP	5.0	°C/W
R _{thj-amb}	Thermal resistance junction-ambient Max		62.5	°C/W

2 Electrical characteristics

($T_{CASE}=25^{\circ}\text{C}$ unless otherwise specified)

Table 3. Static

Symbol	Parameter	Test conditions	Min.	Typ.	Max.	Unit
$V_{BR(CES)}$	Collector-emitter breakdown voltage	$I_C = 1\text{mA}, V_{GE} = 0$	600			V
$V_{CE(sat)}$	Collector-emitter saturation voltage	$V_{GE} = 15\text{V}, I_C = 5\text{A}$		2.2	2.5	V
		$V_{GE} = 15\text{V}, I_C = 5\text{A}, T_C = 125^{\circ}\text{C}$		1.8		V
$V_{GE(th)}$	Gate threshold voltage	$V_{CE} = V_{GE}, I_C = 250\ \mu\text{A}$	4.5		6.5	V
I_{CES}	Collector cut-off current ($V_{GE} = 0$)	$V_{CE} = \text{Max rating}, T_C = 25^{\circ}\text{C}$			150	μA
		$V_{CE} = \text{Max rating}, T_C = 125^{\circ}\text{C}$			1	mA
I_{GES}	Gate-emitter leakage current ($V_{CE} = 0$)	$V_{GE} = \pm 20\text{V}, V_{CE} = 0$			± 100	nA
g_{fs}	Forward transconductance	$V_{CE} = 15\text{V}, I_C = 5\text{A}$		15		S

Table 4. Dynamic

Symbol	Parameter	Test conditions	Min.	Typ.	Max.	Unit
C_{ies} C_{oes} C_{res}	Input capacitance	$V_{CE} = 25\text{V}, f = 1\text{MHz},$ $V_{GE} = 0$		380		pF
	Output capacitance			46		pF
	Reverse transfer capacitance			8.5		pF
Q_g Q_{ge} Q_{gc}	Total gate charge	$V_{CE} = 390\text{V}, I_C = 5\text{A},$		19		nC
	Gate-emitter charge	$V_{GE} = 15\text{V},$		5		nC
	Gate-collector charge	(see Figure 18)		9		nC

Table 5. Switching on/off (inductive load)

Symbol	Parameter	Test conditions	Min.	Typ.	Max.	Unit
$t_{d(on)}$ t_r $(di/dt)_{on}$	Turn-on delay time Current rise time Turn-on current slope	$V_{CC} = 390V, I_C = 5A$ $R_G = 10\Omega, V_{GE} = 15V, T_j = 25^\circ C$ (see Figure 19)		17 6 655		ns ns A/ μs
$t_{d(on)}$ t_r $(di/dt)_{on}$	Turn-on delay time Current rise time Turn-on current slope	$V_{CC} = 390V, I_C = 5A$ $R_G = 10\Omega, V_{GE} = 15V,$ $T_j = 125^\circ C$ (see Figure 19)		16.5 6.5 575		ns ns A/ μs
$t_r(V_{off})$ $t_{d(off)}$ t_f	Off voltage rise time Turn-off delay time Current fall time	$V_{CC} = 390V, I_C = 5A,$ $R_{GE} = 10\Omega, V_{GE} = 15V, T_j = 25^\circ C$ (see Figure 19)		33 72 82		ns ns ns
$t_r(V_{off})$ $t_{d(off)}$ t_f	Off voltage rise time Turn-off delay time Current fall time	$V_{CC} = 390V, I_C = 5A,$ $R_{GE} = 10\Omega, V_{GE} = 15V,$ $T_j = 125^\circ C$ (see Figure 19)		60 106 136		ns ns ns

Table 6. Switching energy (inductive load)

Symbol	Parameter	Test conditions	Min.	Typ.	Max.	Unit
$E_{on}^{(1)}$ $E_{off}^{(2)}$ E_{ts}	Turn-on switching losses Turn-off switching losses Total switching losses	$V_{CC} = 390V, I_C = 5A$ $R_G = 10\Omega, V_{GE} = 15V, T_j = 25^\circ C$ (see Figure 19)		55 85 140		μJ μJ μJ
$E_{on}^{(1)}$ $E_{off}^{(2)}$ E_{ts}	Turn-on switching losses Turn-off switching losses Total switching losses	$V_{CC} = 390V, I_C = 5A$ $R_G = 10\Omega, V_{GE} = 15V,$ $T_j = 125^\circ C$ (see Figure 19)		87 162 249		μJ μJ μJ

1. E_{on} is the turn-on losses when a typical diode is used in the test circuit in figure 2. If the IGBT is offered in a package with a co-pak diode, the co-pak diode is used as external diode. IGBTs & Diode are at the same temperature (25°C and 125°C)
2. Turn-off losses include also the tail of the collector current

Table 7. Collector-emitter diode

Symbol	Parameter	Test conditions	Min.	Typ.	Max.	Unit
V_f	Forward on-voltage	$I_f = 2.5A$		1.6	2.1	V
		$I_f = 2.5A, T_j = 125^\circ C$		1.3		V
t_{rr}	Reverse recovery time	$I_f = 5A, V_R = 30V,$		23.5		ns
Q_{rr}	Reverse recovery charge	$T_j = 25^\circ C, di/dt = 100 A/\mu s$		16.5		nC
I_{rrm}	Reverse recovery current	(see Figure 20)		1.4		A
t_{rr}	Reverse recovery time	$I_f = 5A, V_R = 30V,$		39		ns
Q_{rr}	Reverse recovery charge	$T_j = 125^\circ C, di/dt = 100A/\mu s$		39		nC
I_{rrm}	Reverse recovery current	(see Figure 20)		2		A

2.1 Electrical characteristics (curves)

Figure 1. Output characteristics

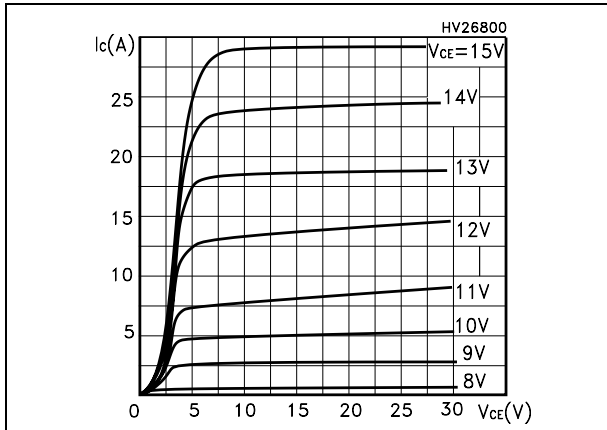

Figure 2. Transfer characteristics

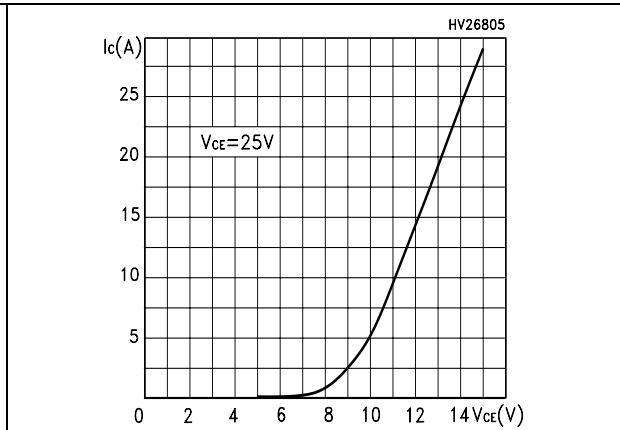

Figure 3. Transconductance

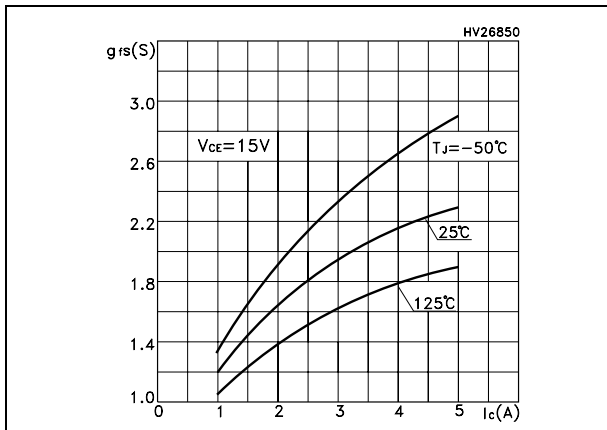

Figure 4. Collector-emitter on voltage vs temperature

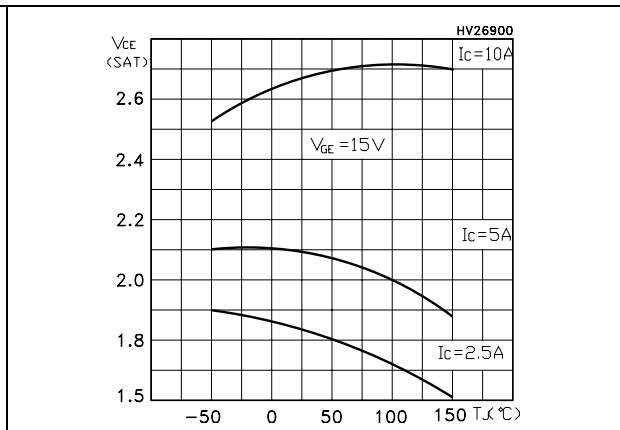

Figure 5. Gate charge vs gate-source voltage

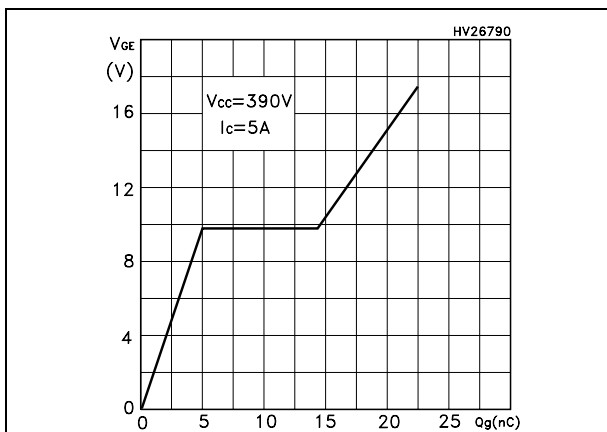

Figure 6. Capacitance variations

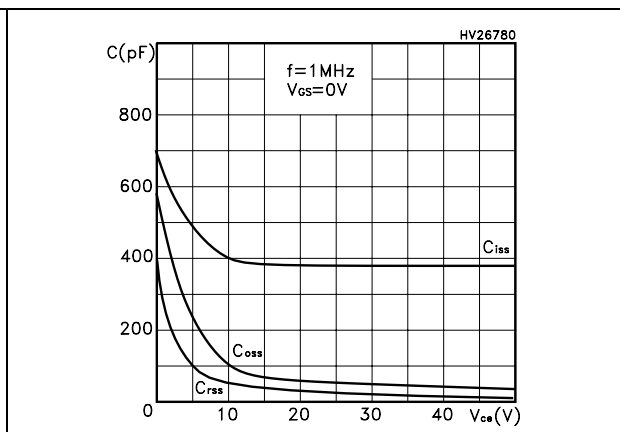

Figure 7. Normalized gate threshold voltage vs temperature

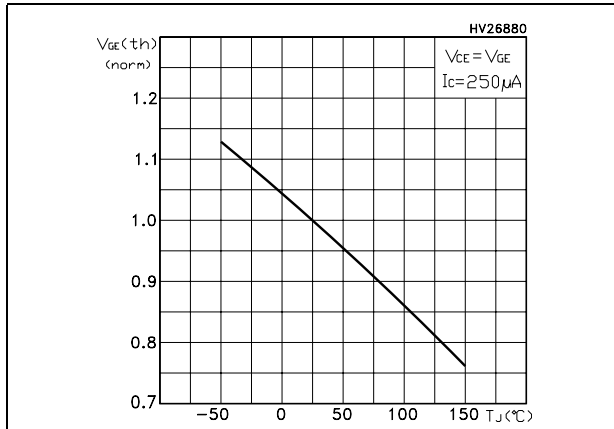

Figure 8. Collector-emitter on voltage vs collector current

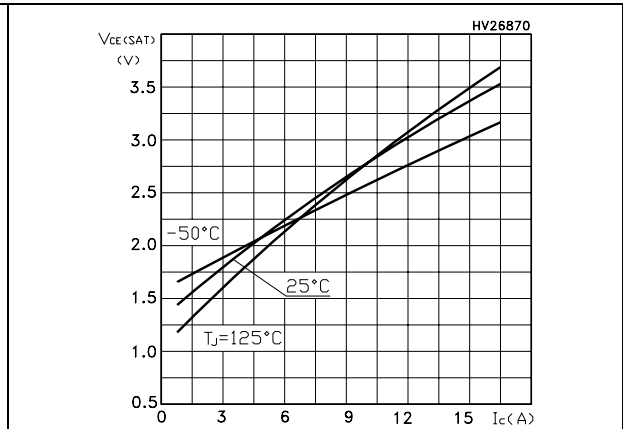

Figure 9. Normalized breakdown voltage vs temperature

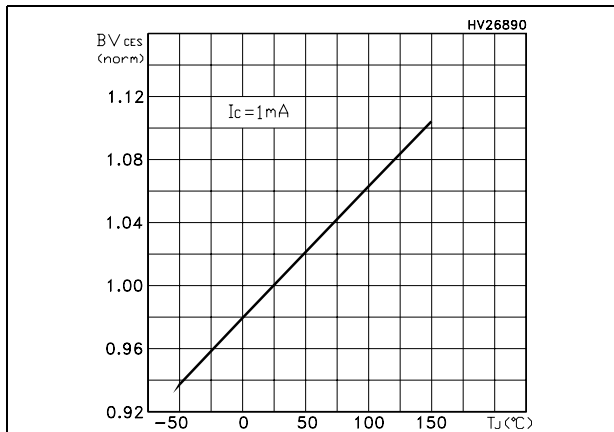

Figure 10. Switching losses vs temperature

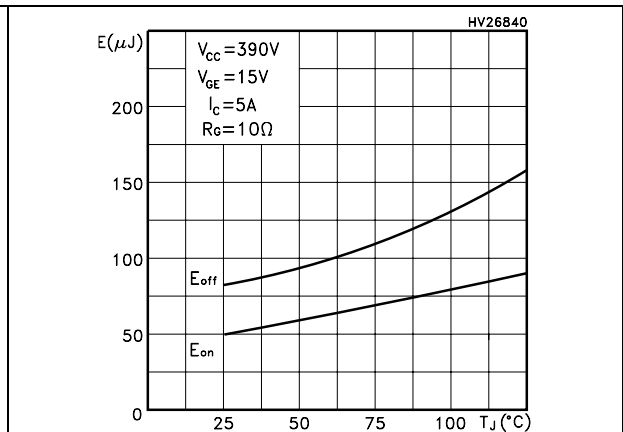

Figure 11. Switching losses vs gate resistance

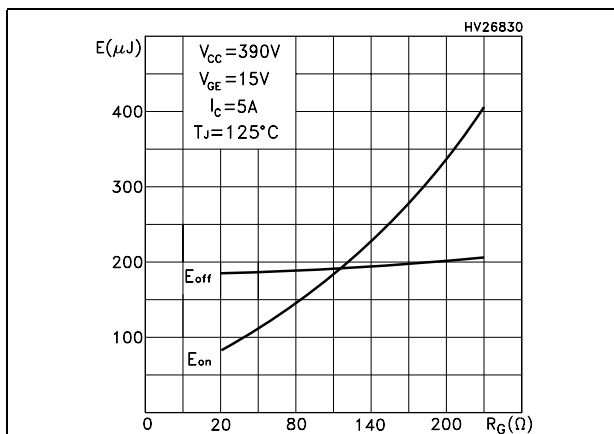

Figure 12. Switching losses vs collector current

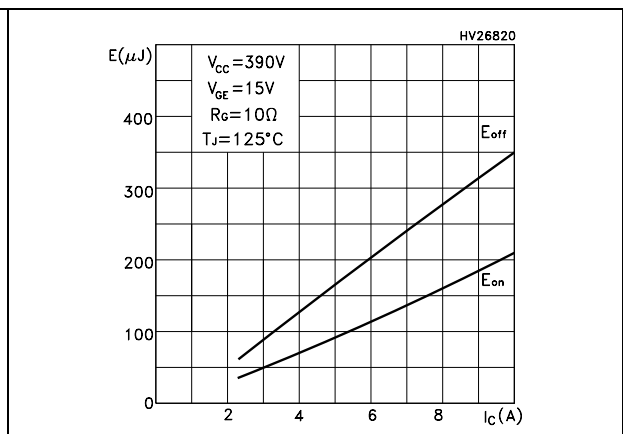

Figure 13. Thermal impedance for TO-220/
D²PAK

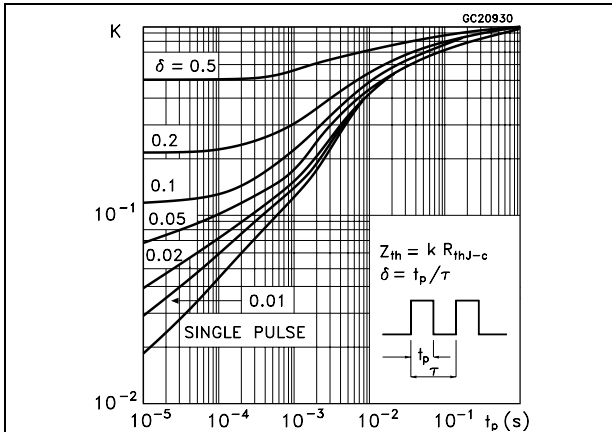

Figure 14. Turn-off SOA

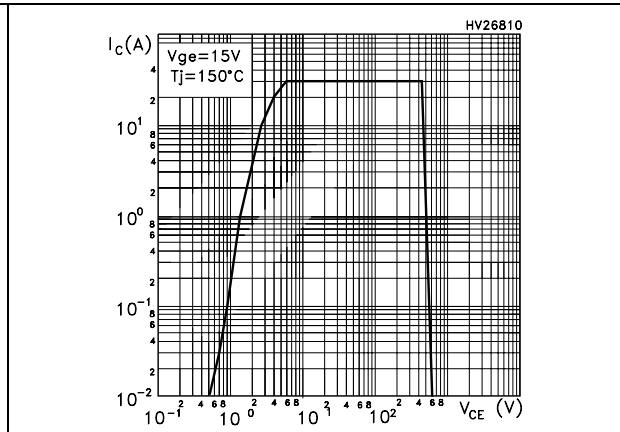

Figure 15. Emitter-collector diode
characteristics

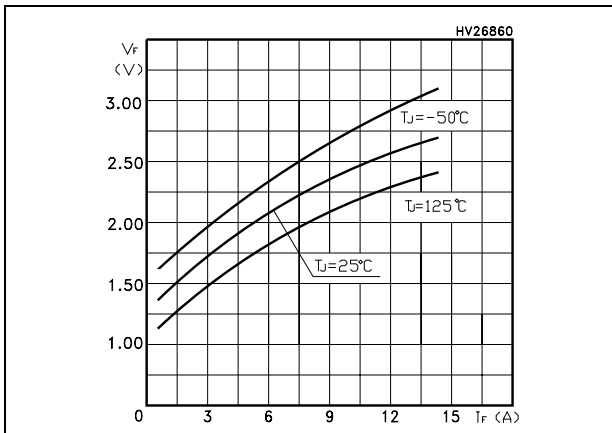
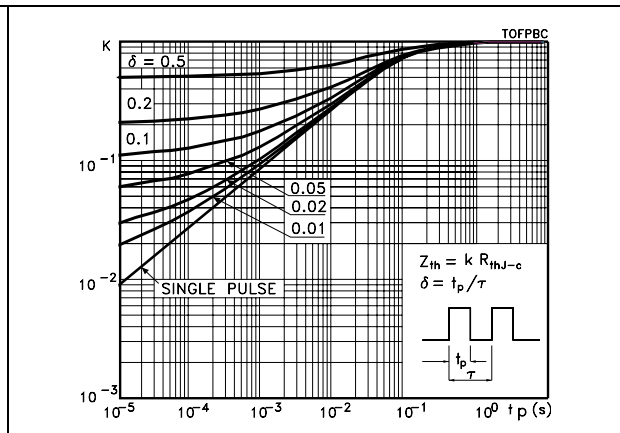

Figure 16. Thermal impedance for TO-220FP



4 Package mechanical data

In order to meet environmental requirements, ST offers these devices in ECOPACK® packages. These packages have a Lead-free second level interconnect. The category of second level interconnect is marked on the package and on the inner box label, in compliance with JEDEC Standard JESD97. The maximum ratings related to soldering conditions are also marked on the inner box label. ECOPACK is an ST trademark. ECOPACK specifications are available at: www.st.com

TO-220 MECHANICAL DATA

DIM.	mm.			inch		
	MIN.	TYP.	MAX.	MIN.	TYP.	MAX.
A	4.40		4.60	0.173		0.181
b	0.61		0.88	0.024		0.034
b1	1.15		1.70	0.045		0.066
c	0.49		0.70	0.019		0.027
D	15.25		15.75	0.60		0.620
E	10		10.40	0.393		0.409
e	2.40		2.70	0.094		0.106
e1	4.95		5.15	0.194		0.202
F	1.23		1.32	0.048		0.052
H1	6.20		6.60	0.244		0.256
J1	2.40		2.72	0.094		0.107
L	13		14	0.511		0.551
L1	3.50		3.93	0.137		0.154
L20		16.40			0.645	
L30		28.90			1.137	
øP	3.75		3.85	0.147		0.151
Q	2.65		2.95	0.104		0.116

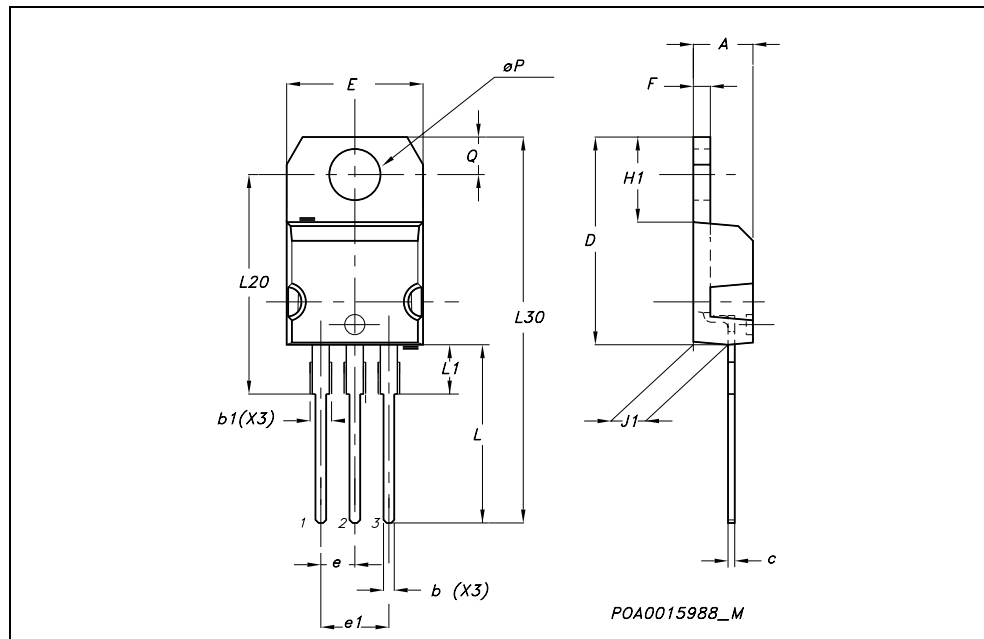

D²PAK MECHANICAL DATA

DIM.	mm.			inch		
	MIN.	TYP	MAX.	MIN.	TYP.	MAX.
A	4.4		4.6	0.173		0.181
A1	2.49		2.69	0.098		0.106
A2	0.03		0.23	0.001		0.009
B	0.7		0.93	0.027		0.036
B2	1.14		1.7	0.044		0.067
C	0.45		0.6	0.017		0.023
C2	1.23		1.36	0.048		0.053
D	8.95		9.35	0.352		0.368
D1		8			0.315	
E	10		10.4	0.393		
E1		8.5			0.334	
G	4.88		5.28	0.192		0.208
L	15		15.85	0.590		0.625
L2	1.27		1.4	0.050		0.055
L3	1.4		1.75	0.055		0.068
M	2.4		3.2	0.094		0.126
R		0.4			0.015	
V2	0°		4°			

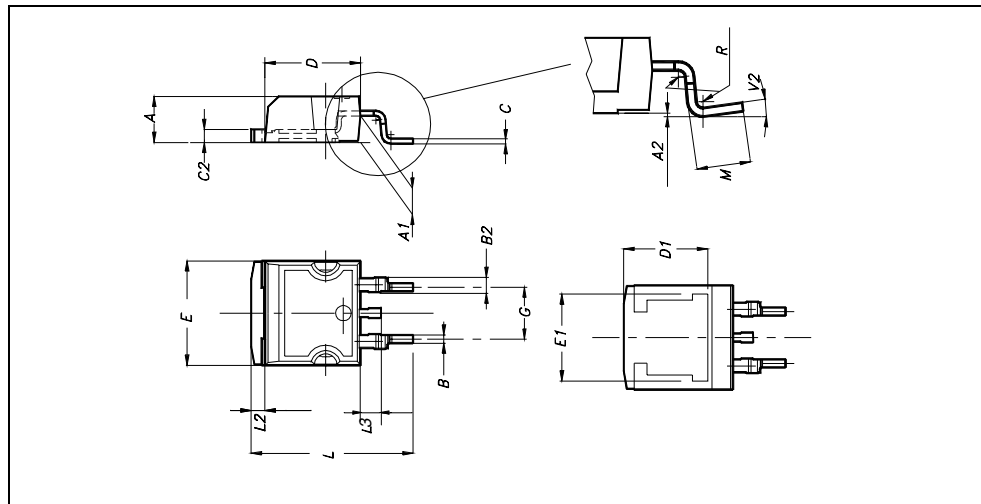

TO-220FP MECHANICAL DATA

DIM.	mm.			inch		
	MIN.	TYP	MAX.	MIN.	TYP.	MAX.
A	4.4		4.6	0.173		0.181
B	2.5		2.7	0.098		0.106
D	2.5		2.75	0.098		0.108
E	0.45		0.7	0.017		0.027
F	0.75		1	0.030		0.039
F1	1.15		1.7	0.045		0.067
F2	1.15		1.7	0.045		0.067
G	4.95		5.2	0.195		0.204
G1	2.4		2.7	0.094		0.106
H	10		10.4	0.393		0.409
L2		16			0.630	
L3	28.6		30.6	1.126		1.204
L4	9.8		10.6	.0385		0.417
L5	2.9		3.6	0.114		0.141
L6	15.9		16.4	0.626		0.645
L7	9		9.3	0.354		0.366
Ø	3		3.2	0.118		0.126

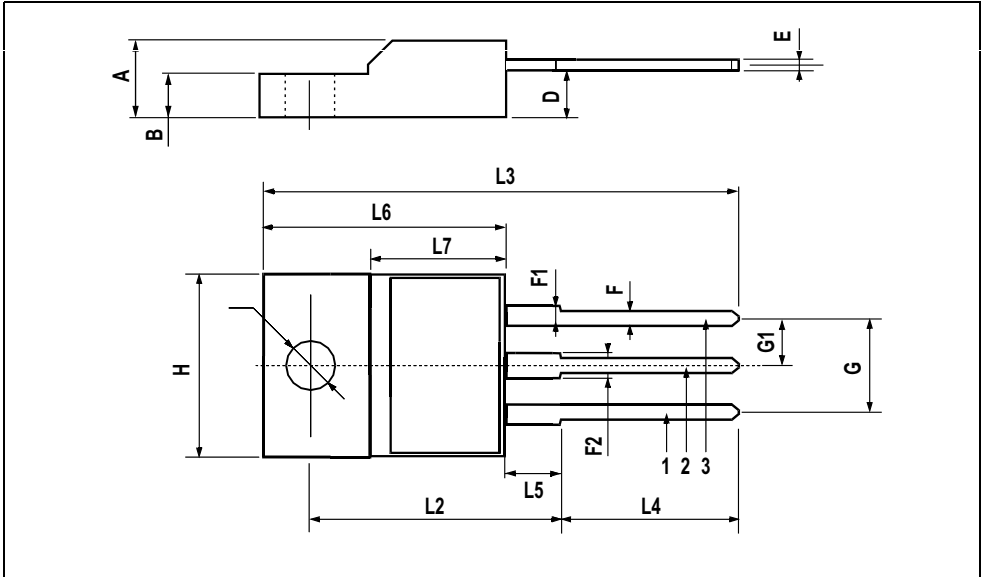

5 Packaging mechanical data

D²PAK FOOTPRINT



TAPE AND REEL SHIPMENT

TAPE MECHANICAL DATA

DIM.	mm		inch	
	MIN.	MAX.	MIN.	MAX.
A0	10.5	10.7	0.413	0.421
B0	15.7	15.9	0.618	0.626
D	1.5	1.6	0.059	0.063
D1	1.59	1.61	0.062	0.063
E	1.65	1.85	0.065	0.073
F	11.4	11.6	0.449	0.456
K0	4.8	5.0	0.189	0.197
P0	3.9	4.1	0.153	0.161
P1	11.9	12.1	0.468	0.476
P2	1.9	2.1	0.075	0.082
R	50		1.574	
T	0.25	0.35	0.0098	0.0137
W	23.7	24.3	0.933	0.956

REEL MECHANICAL DATA

DIM.	mm		inch	
	MIN.	MAX.	MIN.	MAX.
A		330		12.992
B	1.5		0.059	
C	12.8	13.2	0.504	0.520
D	20.2		0.795	
G	24.4	26.4	0.960	1.039
N	100		3.937	
T		30.4		1.197

BASE QTY	BULK QTY
1000	1000

10 pitches cumulative tolerance on tape +/- 0.2 mm

Center line of cavity

User Direction of Feed

FEED DIRECTION

TRL

Bending radius R min.

* on sales type

6 Revision history

Table 8. Revision history

Date	Revision	Changes
14-Jun-2005	1	New release
19-Jul-2005	2	Complete version
27-Jan-2006	3	Inserted ecopack indication
01-Mar-2006	4	The document has been reformatted
08-Feb-2007	5	Modified value on Table 5.: Switching on/off (inductive load)

Please Read Carefully:

Information in this document is provided solely in connection with ST products. STMicroelectronics NV and its subsidiaries ("ST") reserve the right to make changes, corrections, modifications or improvements, to this document, and the products and services described herein at any time, without notice.

All ST products are sold pursuant to ST's terms and conditions of sale.

Purchasers are solely responsible for the choice, selection and use of the ST products and services described herein, and ST assumes no liability whatsoever relating to the choice, selection or use of the ST products and services described herein.

No license, express or implied, by estoppel or otherwise, to any intellectual property rights is granted under this document. If any part of this document refers to any third party products or services it shall not be deemed a license grant by ST for the use of such third party products or services, or any intellectual property contained therein or considered as a warranty covering the use in any manner whatsoever of such third party products or services or any intellectual property contained therein.

UNLESS OTHERWISE SET FORTH IN ST'S TERMS AND CONDITIONS OF SALE ST DISCLAIMS ANY EXPRESS OR IMPLIED WARRANTY WITH RESPECT TO THE USE AND/OR SALE OF ST PRODUCTS INCLUDING WITHOUT LIMITATION IMPLIED WARRANTIES OF MERCHANTABILITY, FITNESS FOR A PARTICULAR PURPOSE (AND THEIR EQUIVALENTS UNDER THE LAWS OF ANY JURISDICTION), OR INFRINGEMENT OF ANY PATENT, COPYRIGHT OR OTHER INTELLECTUAL PROPERTY RIGHT.

UNLESS EXPRESSLY APPROVED IN WRITING BY AN AUTHORIZED ST REPRESENTATIVE, ST PRODUCTS ARE NOT RECOMMENDED, AUTHORIZED OR WARRANTED FOR USE IN MILITARY, AIR CRAFT, SPACE, LIFE SAVING, OR LIFE SUSTAINING APPLICATIONS, NOR IN PRODUCTS OR SYSTEMS WHERE FAILURE OR MALFUNCTION MAY RESULT IN PERSONAL INJURY, DEATH, OR SEVERE PROPERTY OR ENVIRONMENTAL DAMAGE. ST PRODUCTS WHICH ARE NOT SPECIFIED AS "AUTOMOTIVE GRADE" MAY ONLY BE USED IN AUTOMOTIVE APPLICATIONS AT USER'S OWN RISK.

Resale of ST products with provisions different from the statements and/or technical features set forth in this document shall immediately void any warranty granted by ST for the ST product or service described herein and shall not create or extend in any manner whatsoever, any liability of ST.

ST and the ST logo are trademarks or registered trademarks of ST in various countries.

Information in this document supersedes and replaces all information previously supplied.

The ST logo is a registered trademark of STMicroelectronics. All other names are the property of their respective owners.

© 2007 STMicroelectronics - All rights reserved

STMicroelectronics group of companies

Australia - Belgium - Brazil - Canada - China - Czech Republic - Finland - France - Germany - Hong Kong - India - Israel - Italy - Japan - Malaysia - Malta - Morocco - Singapore - Spain - Sweden - Switzerland - United Kingdom - United States of America

www.st.com