

## 25A GLASS PASSIVATED SINGLE-PHASE BRIDGE RECTIFIER

### Features

- Glass Passivated Die Construction
- Low Forward Voltage Drop
- High Current Capability
- High Reliability
- High Surge Current Capability
- Ideal for Printed Circuit Boards
-  Recognized File # E157705

### Mechanical Data

- Case: GBJ-6, Molded Plastic
- Terminals: Plated Leads Solderable per MIL-STD-202, Method 208
- Polarity: As Marked on Body
- Weight: 7.0 grams (approx.)
- Mounting Position: Any
- Mounting Torque: 10 cm·kg (8.8 in·lbs) Max.
- **Lead Free: For RoHS / Lead Free Version, Add "-LF" Suffix to Part Number, See Page 4**

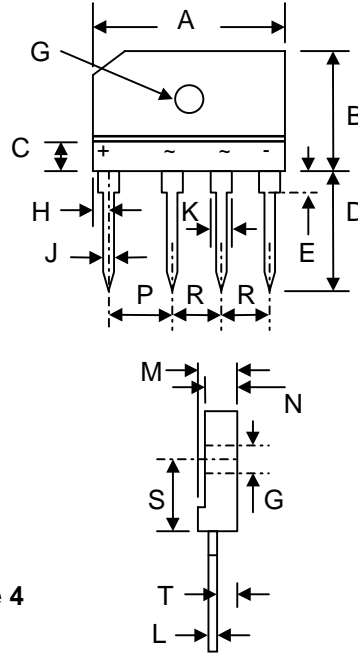

GBJ-6		
Dim	Min	Max
A	29.7	30.3
B	19.7	20.3
C	—	5.0
D	17.0	18.0
E	3.8	4.2
G	3.1Ø	3.4Ø
H	2.3	2.7
J	0.9	1.1
K	1.8	2.2
L	0.6	0.8
M	4.4	4.8
N	3.4	3.8
P	9.8	10.2
R	7.3	7.7
S	10.8	11.2
T	2.3	2.7
All Dimensions in mm		

### Maximum Ratings and Electrical Characteristics @ $T_A=25^\circ\text{C}$ unless otherwise specified

Single Phase, half wave, 60Hz, resistive or inductive load.  
For capacitive load, derate current by 20%.

Characteristic	Symbol	GBJ 25A	GBJ 25B	GBJ 25D	GBJ 25G	GBJ 25J	GBJ 25K	GBJ 25M	Unit
Peak Repetitive Reverse Voltage	$V_{RRM}$								
Working Peak Reverse Voltage	$V_{RWM}$	50	100	200	400	600	800	1000	V
DC Blocking Voltage	$V_R$								
RMS Reverse Voltage	$V_{R(RMS)}$	35	70	140	280	420	560	700	V
Average Rectified Output Current @ $T_C = 100^\circ\text{C}$ (Note 1)	$I_O$	25							A
Non-Repetitive Peak Forward Surge Current 8.3ms Single half sine-wave superimposed on rated load (JEDEC Method)	$I_{FSM}$	350							A
Forward Voltage per diode @ $I_F = 12.5\text{A}$	$V_{FM}$	1.05							V
Peak Reverse Current @ $T_A = 25^\circ\text{C}$ At Rated DC Blocking Voltage @ $T_A = 125^\circ\text{C}$	$I_R$	10 350							$\mu\text{A}$
Typical Thermal Resistance per leg (Note 2)	$R_{\theta JA}$	22							$^\circ\text{C/W}$
Typical Thermal Resistance per leg (Note 1)	$R_{\theta JC}$	1.0							$^\circ\text{C/W}$
Operating and Storage Temperature Range	$T_j, T_{STG}$	-55 to +150							$^\circ\text{C}$

Note: 1. Device mounted on 220 x 220 x 1.6mm thick Al plate heatsink.  
2. Device mounted on P.C.B. without heatsink.

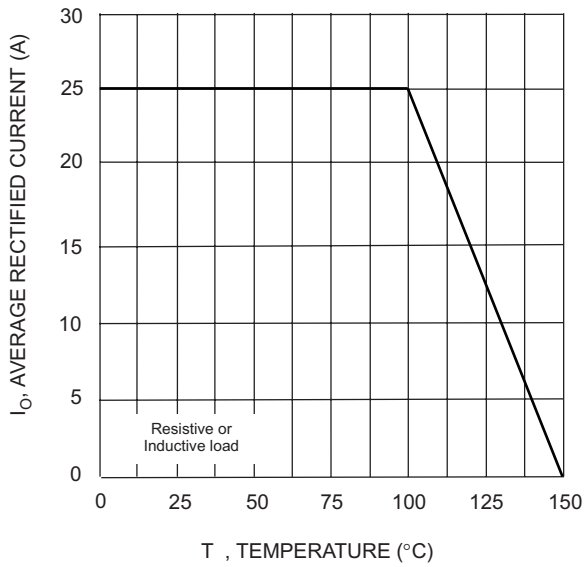

Fig. 1 Forward Current Derating Curve

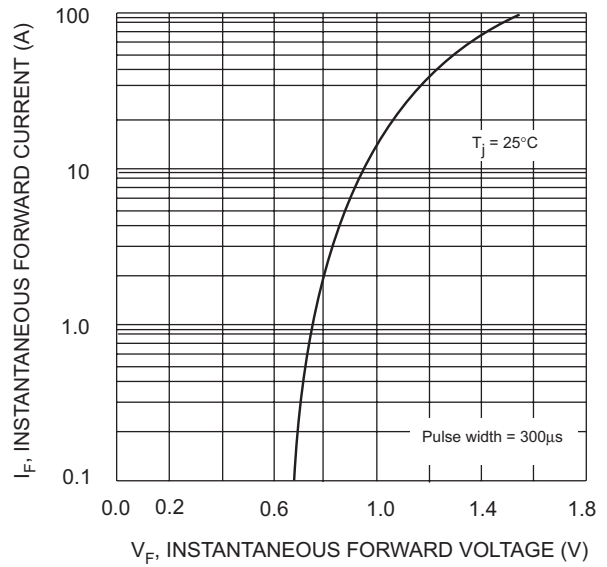

Fig. 2 Typical Fwd Characteristics, per element

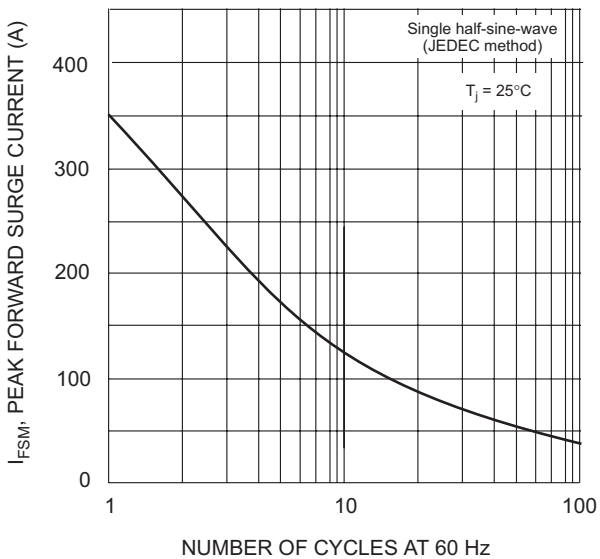

Fig. 3 Maximum Non-Repetitive Surge Current

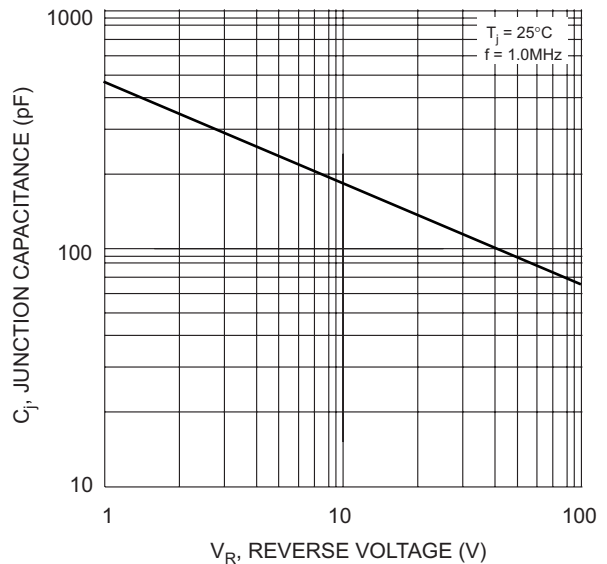
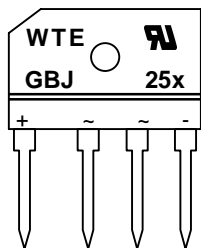

Fig. 4 Typical Junction Capacitance

## MARKING INFORMATION



WTE = Manufacturer's Logo  
 GBJ25x = Device Number  
 x = A, B, D, G, J, K or M  
 Polarity = As Marked on Body

## PACKAGING INFORMATION

### BULK

Tube Size L x W x H (mm)	Quantity (PCS)	Inner Box Size L x W x H (mm)	Quantity (PCS)	Carton Size L x W x H (mm)	Quantity (PCS)	Approx. Gross Weight (KG)
475 x 40 x 7	15	490 x 145 x 135	750	510 x 305 x 160	1,500	16.0

**Note:** 1. Anti-static tube, water clear color.

## ORDERING INFORMATION

Product No.	Package Type	Shipping Quantity
GBJ25A	SIL Bridge	15 Units/Tube
GBJ25B	SIL Bridge	15 Units/Tube
GBJ25D	SIL Bridge	15 Units/Tube
GBJ25G	SIL Bridge	15 Units/Tube
GBJ25J	SIL Bridge	15 Units/Tube
GBJ25K	SIL Bridge	15 Units/Tube
GBJ25M	SIL Bridge	15 Units/Tube

1. Shipping quantity given is for minimum packing quantity only. For minimum order quantity, please consult the Sales Department.
2. **To order Lead Free version (with Lead Free finish), add "-LF" suffix to part number above. For example, GBJ25A-LF.**

Won-Top Electronics Co., Ltd (WTE) has checked all information carefully and believes it to be correct and accurate. However, WTE cannot assume any responsibility for inaccuracies. Furthermore, this information does not give the purchaser of semiconductor devices any license under patent rights to manufacturer. WTE reserves the right to change any or all information herein without further notice.

**WARNING:** DO NOT USE IN LIFE SUPPORT EQUIPMENT. WTE power semiconductor products are not authorized for use as critical components in life support devices or systems without the express written approval.

**Won-Top Electronics Co., Ltd.**

No. 44 Yu Kang North 3rd Road, Chine Chen Dist., Kaohsiung, Taiwan

**Phone:** 886-7-822-5408 or 886-7-822-5410

**Fax:** 886-7-822-5417

**Email:** sales@wontop.com

**Internet:** <http://www.wontop.com>

*We power your everyday.*