

GCU08AA-130

HIGH POWER INVERTER USE
PRESS PACK TYPE

GCU08AA-130

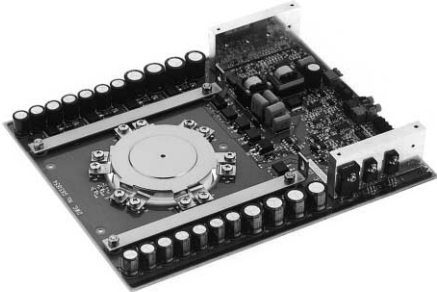

- Symmetrical GCT unit
- GCT and Gate driver are connected
- ITQRM Repetitive controllable on-state current 800A
- IT(AV) Average on-state current 330A
- VDRM Repetitive peak off-state voltage 6500V
- VRRM Repetitive peak reverse voltage 6500V

APPLICATION

Current source inverters, DC choppers, Induction heaters, DC to DC converters.

OUTLINE DRAWING

Dimensions in mm

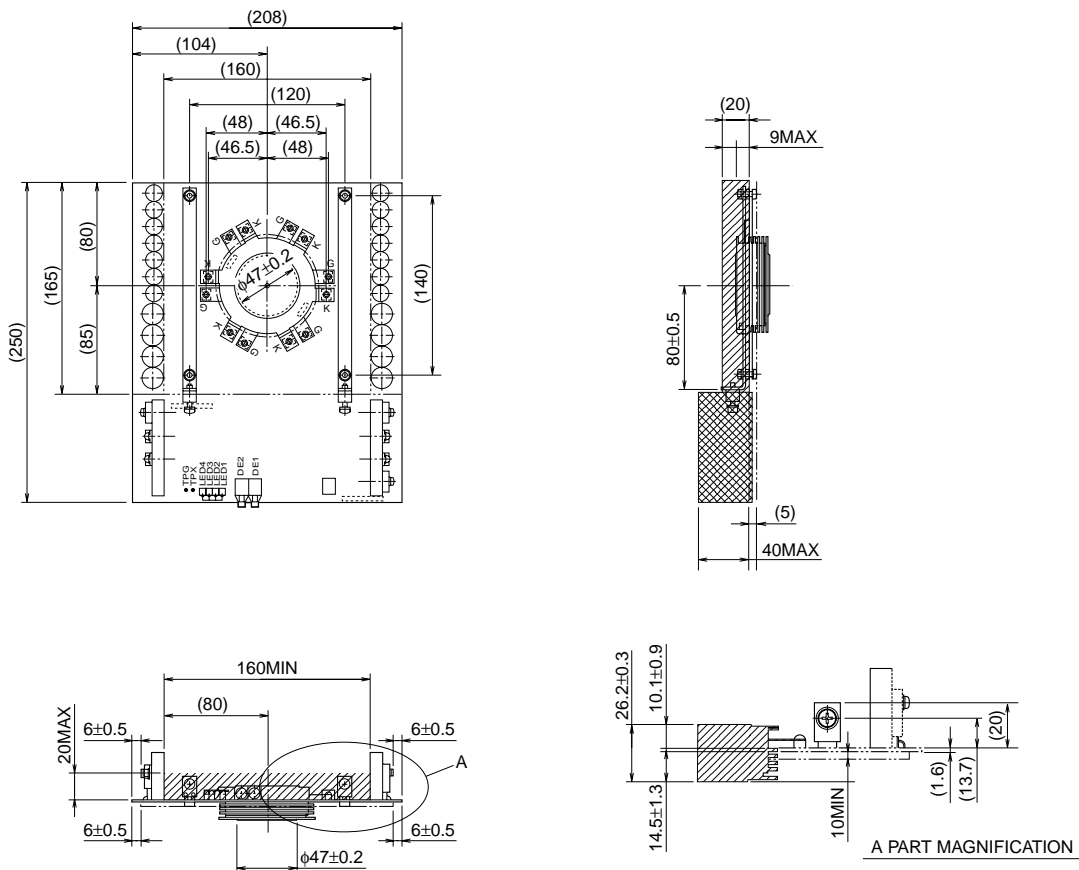

GCT PART (Type name : FGC800A-130DS)

MAXIMUM RATINGS

Symbol	Parameter	Conditions	Voltage class	Unit
VRRM	Repetitive peak reverse voltage	—	6500	V
VRSM	Non-repetitive peak reverse voltage	—	6500	V
VDRM	Repetitive peak off-state voltage	VGK = -2V	6500	V
VDSM	Non-repetitive peak off-state voltage	VGK = -2V	6500	V
VLTD5	Long term DC stability voltage	VGK = -2V, λ = 100 Fit	3600	V

Symbol	Parameter	Conditions	Ratings	Unit
ITQRM	Repetitive controllable on-state current	VDM = 3/4 VDRM, VD = 3000V, LC = 0.3μH Tj = 25/115°C, With GU-D08 (see Fig. 1, 3)	800	A
IT(RMS)	RMS on-state current	Applied for all conduction angles	520	A
IT(AV)	Average on-state current	f = 60Hz, sinewave θ = 180°, Tf = 55°C	330	A
ITSM	Surge on-state current	One half cycle at 60Hz, Tj = 115°C Start	4.8	kA
i ² t	Current-squared, time integration		9.6 × 10 ⁴	A ² s
diT/dt	Critical rate of rise of on-state current	VD = 3000V, IT = 800A, Cs= 0.1μF, RS= 10Ω Tj = 25/115°C, f = 60Hz, With GU-D08 (see Fig. 1,2)	1000	A/μs
VFGM	Peak forward gate voltage		10	V
VRGM	Peak reverse gate voltage		21	V
IFGM	Peak forward gate current		500	A
IRGM	Peak reverse gate current		800	A
PFGM	Peak forward gate power dissipation		5	kW
PRGM	Peak reverse gate power dissipation		17	kW
PFG(AV)	Average forward gate power dissipation		100	W
PRG(AV)	Average reverse gate power dissipation		120	W
Tj	Junction temperature		-20 ~ +115	°C
Tstg	Storage temperature		-20 ~ +150	°C
—	Mounting force required	(Recommended value 13kN)	11.1 ~ 15.8	kN
—	Weight	Typical value	530	g

ELECTRICAL CHARACTERISTICS

Symbol	Parameter	Conditions	Limits			Unit
			Min	Typ	Max	
V _{TM}	On-state voltage	IT = 800A, Tj = 115°C	—	—	6.8	V
I _{RRM}	Repetitive peak reverse current	VRM = 6500V, Tj = 115°C	—	—	150	mA
I _{DRM}	Repetitive peak off-state current	VDM = 6500V, VGK = -2V, Tj = 115°C	—	—	100	mA
I _{GRM}	Reverse gate current	VRG = 21V, Tj = 115°C	—	—	50	mA
dV/dt	Critical rate of rise of off-state voltage	VD = 3000V, VGK = -2V, Tj = 115°C (Expo. wave)	3000	—	—	V/μs
t _{gt}	Turn-on time	IT = 800A, VD = 3000V, di/dt = 1000A/μs, Tj = 115°C	—	—	5.0	μs
t _d	Delay time	Cs= 0.1μF, RS = 10Ω	—	—	1.0	μs
E _{on}	Turn-on switching energy	With GU-D08 (see Fig. 1, 2)	—	—	1.6	J/P
t _s	Storage time	IT = 800A, VDM = 3/4 VDRM, VD = 3000V Cs= 0.1μF, RS = 10Ω, Tj = 115°C	—	—	3.0	μs
E _{off}	Turn-off switching energy	With GU-D08 (see Fig. 1, 5)	—	—	6.0	J/P
Q _{RR}	Reverse recovery charge	VR = 3000V, IT = 800A, di/dt = 1000A/μs	—	—	1650	μC
E _{rec}	Reverse recovery energy	Cs= 0.1μF, RS = 10Ω, Tj = 115°C (see Fig. 4, 5)	—	—	5.0	J/P
I _{GT}	Gate trigger current	DC METHOD : VD = 24V, RL = 0.1Ω, Tj = 25°C	—	—	0.5	A
V _{GT}	Gate trigger voltage		—	—	1.5	V
R _{th(j-f)}	Thermal resistance	Junction to fin	—	—	0.025	K/W

GCU08AA-130

HIGH POWER INVERTER USE
PRESS PACK TYPE

GATE DRIVER PART (Type name : GU-D08)

Symbol	Parameter	Conditions	Limits			Unit
			Min	Typ	Max	
VC	Power supply (Note 1)	DC power supply	19	20	21	V
P	Power consumption (Note 2)	—	2.5	—	—	W
		$I_T = 330A_{rms}$, $f = 780Hz$, duty = 0.33	—	—	35	
—	Control signal (Note 3)	Optical fiber data link Transmitter : HFBR-1521 (HP) Receiver : HFBR-2521 (HP)	—	—	—	—
f	Frequency	$I_T = 330A_{rms}$, duty = 0.33	—	—	780	Hz
t _{fd}	Delay time of on gate current		—	—	3.0	μs
t _{rd}	Delay time of off gate current		—	—	3.0	μs
diG/dt	Critical rate of rise of on gate current		50	—	—	A/μs
I _{GM}	Peak on gate current		—	90	—	A
t _w	Width of on high gate current		3	—	—	μs
I _G	On gate current	$T_j \geq -10^\circ C$	1.25	—	—	A
diGQ/dt	Critical rate of rise of off gate current	VRG= 20V	—	1200	—	A/μs
D _{max}	Maximum duty		—	—	100	%
T _a	Temperature	Operation temperature (Recommend : $\leq 40^\circ C$)	-10	—	+60	°C
—	Weight	With FGC800A-130DS	—	1150	—	g
—	Status signal (Note 4)		—	—	—	—

GCU08AA-130

HIGH POWER INVERTER USE
PRESS PACK TYPE

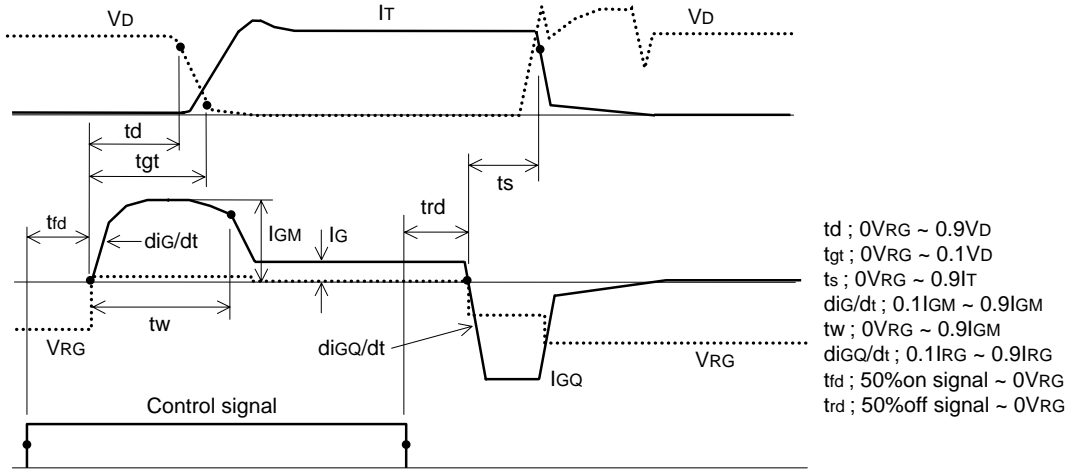

Fig. 1 Turn-on and Turn-off waveform

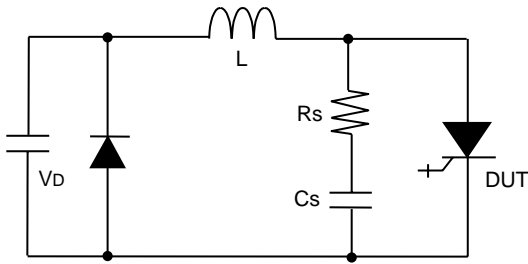

Fig. 2 Turn-on test circuit

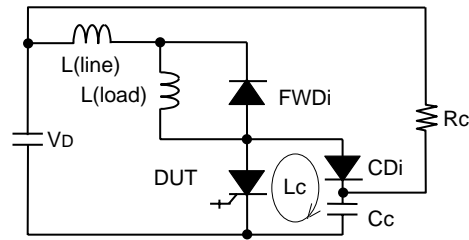

Fig. 3 Turn-off test circuit
(With clamp circuit)

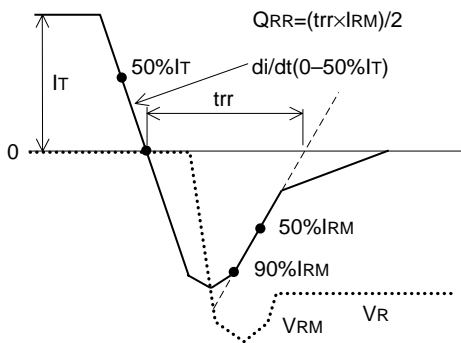

Fig. 4 Reverse recovery waveform

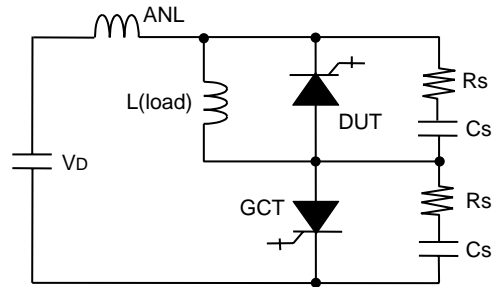

Fig. 5 Turn-off and Reverse recovery test circuit
(With CR snubber circuit)

GCU08AA-130

HIGH POWER INVERTER USE
PRESS PACK TYPE

- Note 1. (1) Guaranteed power supply voltage for operation is 19V minimum and 21V maximum.
 (2) When over voltage occurs, GDU voltage bus (G-K voltage for GCT) is clamped to be 21V if mamimum voltage for input gata voltage from power supply is 25V and maximum duration of over voltage higher than 21V from power supply is 0.4 sec when control signal is on (Please see Fig. 8).
 (3) When over voltage occurs, GDU voltage bus is clamped to be 21V with no time limitation if maximum voltage from power supply is 25V and control signal is off (Please see Fig. 8).

Note 2. GCT is off state and no gate signal is supplied for gate driver. No leakage current flows between gate and cathode of GCT.

Note 3. Optic fiber data link HFBR-1521 and HFBR-2521 are interlocked each other.

Note 4.

1. Status signal from LED

(1) Status signal

Status of GCT	LED 1 (Red)	LED 2 (Yellow)
On state	OFF	ON
Off state	ON	OFF

(2) Fault signal

Status	G-K	PS	PS LED (LED 4)	G-K LED (LED 3)
Normal	Normal	20±1V	On	On
Fault	Normal	Voltage down	Off, V < 17.5V (Typ.)	Off (If V > 12.5V (Typ.) then LED 3 is on)
Fault	G-K short	20±1V	On	Off
Fault	G-K short	Voltage down	Off, V < 17.5V (Typ.)	Off

2. Status signal from Transmitter (Note 5)

(L : Light NL : No light)

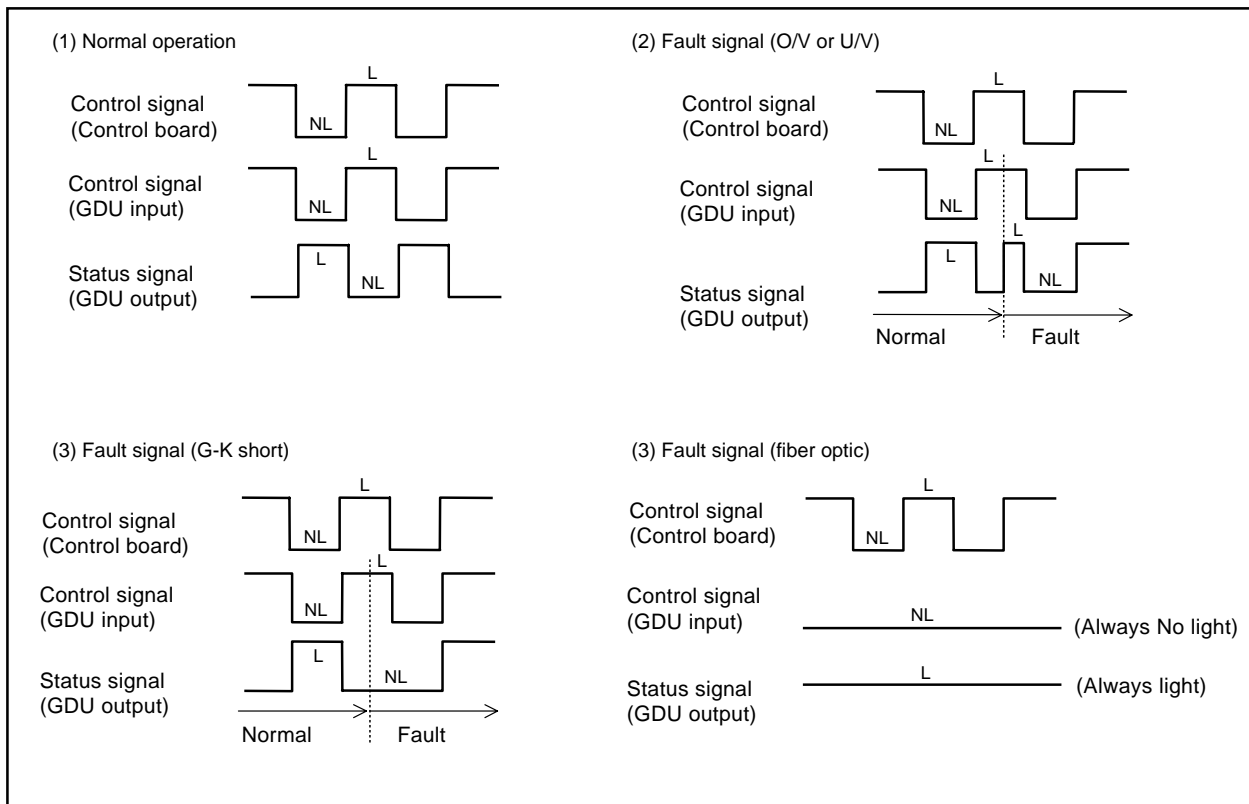

Note 5. About over voltage fault signal, please see Fig. 6.

Fig. 6 Over voltage fault signal timing chart

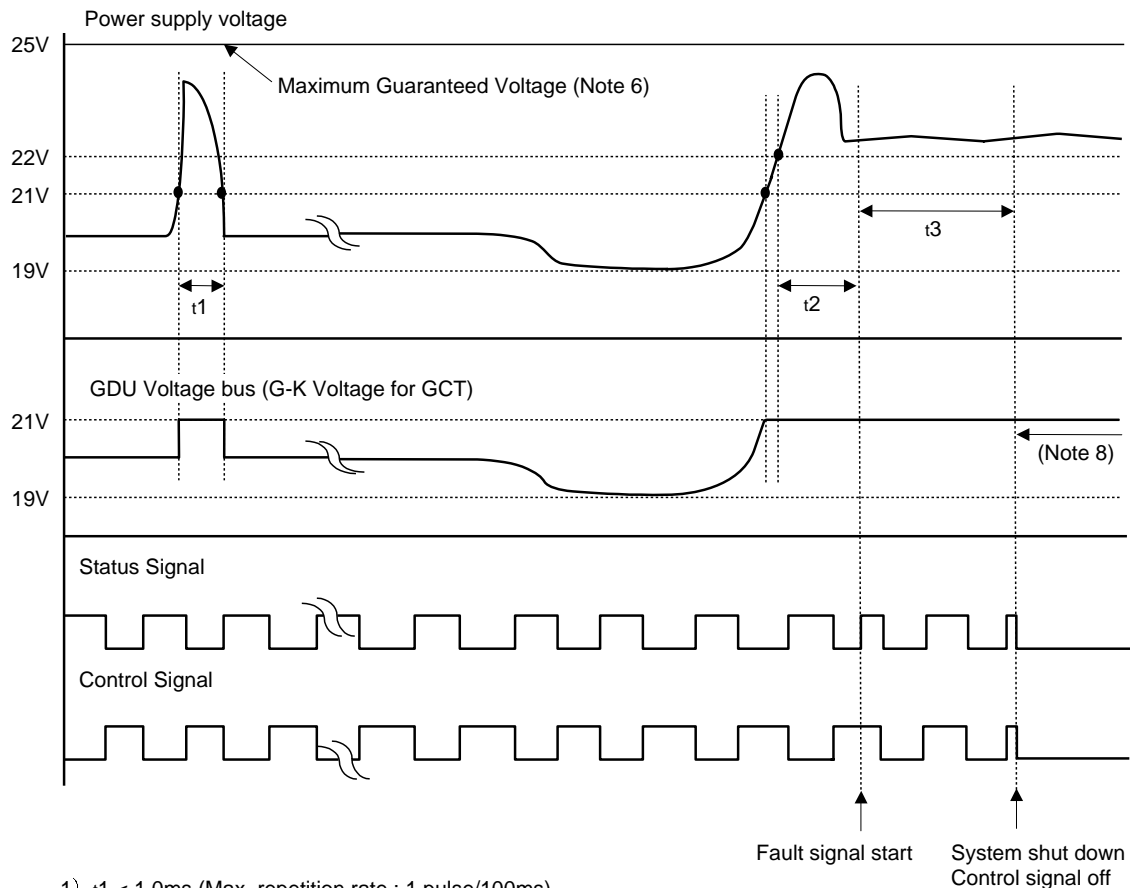

- 1) $t_1 < 1.0\text{ms}$ (Max. repetition rate ; 1 pulse/100ms)
- 2) $t_2 \geq 1.0\text{ms}$
- 3) $t_3 < 0.4\text{sec}$

Note 6. Maximum peak voltage of GDU input voltage from power supply should be lower than 25V.

Note 7. If the period for over voltage $< 1.0\text{ms}$ (period t_1), no fault signal is sent.

If the period for over voltage $\geq 1.0\text{ms}$, fault signal starts after period t_2 from 22V of power supply voltage. System should be shut down (Control signal should be off) within period t_3 from fault signal start.

Note 8. GDU Voltage bus (G-K Voltage for GCT) is clamped to be 21V if power supply voltage is higher than 21V after system shut down (control signal off).

GCU08AA-130

HIGH POWER INVERTER USE
PRESS PACK TYPE

PERFORMANCE CURVES

MAXIMUM ON-STATE CHARACTERISTIC

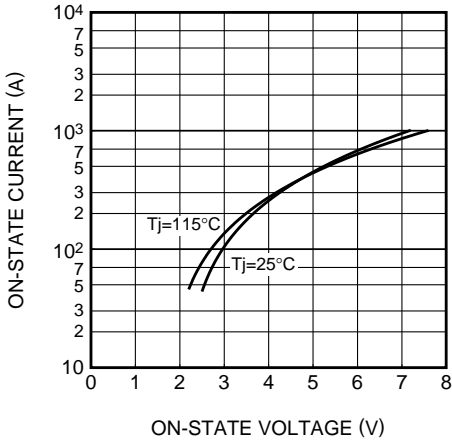

E_{on} VS I_t

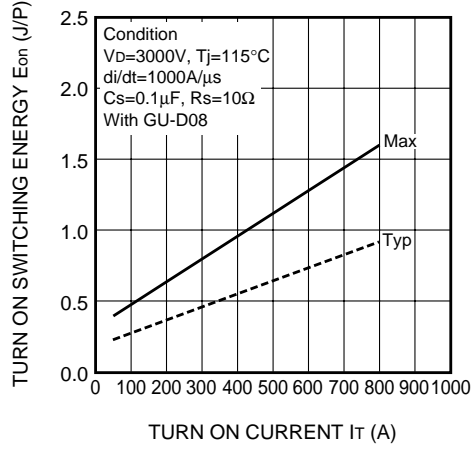

E_{off} VS I_t

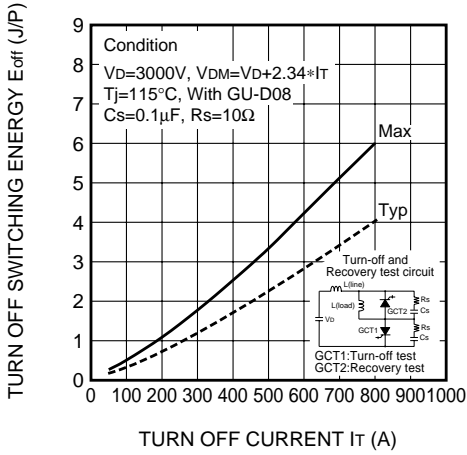

E_{rec} VS I_t

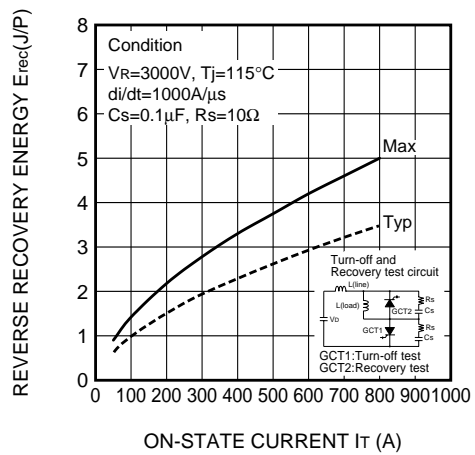

Q_{RR} VS I_t

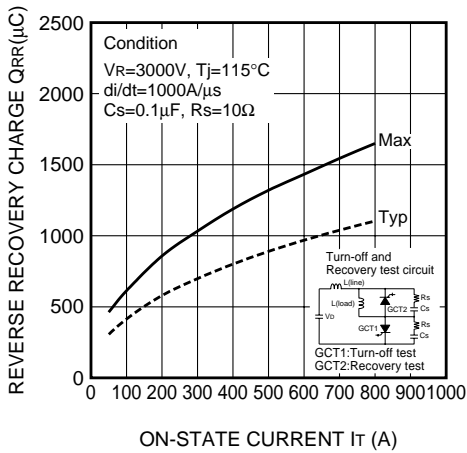

MAXIMUM THERMAL IMPEDANCE CHARACTERISTIC (JUNCTION TO FIN)

