



STGD3NB60HD

N-CHANNEL 6A - 600V - DPAK

PowerMESH™ IGBT

TYPE	V _{CES}	V _{CE(sat)} (Max) @ 25°C	I _C @ 100°C
STGD3NB60HD	600 V	< 2.8 V	6 A

- HIGH INPUT IMPEDANCE
- OFF LOSSES INCLUDE TAIL CURRENT
- LOW GATE CHARGE
- HIGH FREQUENCY OPERATION
- TYPICAL SHORT CIRCUIT WITHSTAND TIME
5micro S-family, 4 micro H family
- CO-PACKAGED WITH TURBOSWITCH™
ANTIPARALLEL DIODE

DESCRIPTION

Using the latest high voltage technology based on a patented strip layout, STMicroelectronics has designed an advanced family of IGBTs, the PowerMESH™ IGBTs, with outstanding performances.

The suffix "H" identifies a family optimized for high frequency applications (up to 50kHz) in order to achieve very high switching performances (reduced t_{fall}) maintaining a low voltage drop.

APPLICATIONS

- HIGH FREQUENCY MOTOR CONTROLS
- SMPS and PFC IN BOTH HARD SWITCH AND
RESONANT TOPOLOGIES

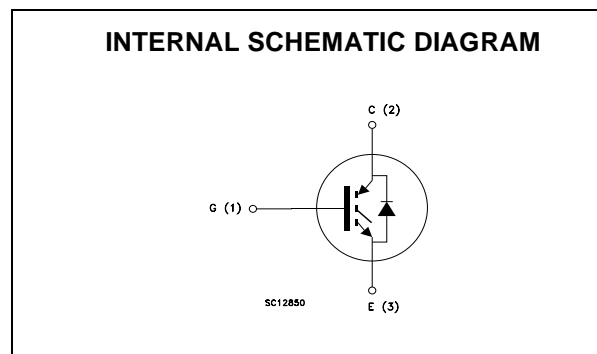
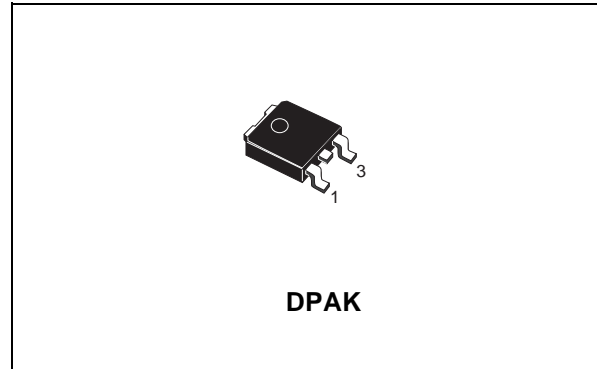

ORDERING INFORMATION

SALES TYPE	MARKING	PACKAGE	PACKAGING
STGD3NB60HDT4	GD3NB60HD	DPAK	TAPE & REEL

STGD3NB60HD

ABSOLUTE MAXIMUM RATINGS

Symbol	Parameter	Value	Unit
V_{CES}	Collector-Emitter Voltage ($V_{GS} = 0$)	600	V
V_{ECR}	Emitter-Collector Voltage	20	V
V_{GE}	Gate-Emitter Voltage	± 20	V
I_C	Collector Current (continuous) at $T_C = 25^\circ\text{C}$	10	A
I_C	Collector Current (continuous) at $T_C = 100^\circ\text{C}$	6	A
I_{CM} (■)	Collector Current (pulsed)	24	A
P_{TOT}	Total Dissipation at $T_C = 25^\circ\text{C}$	50	W
	Derating Factor	0.4	W/ $^\circ\text{C}$
T_{stg}	Storage Temperature	-55 to 150	$^\circ\text{C}$
T_j	Operating Junction Temperature		

(■) Pulse width limited by safe operating area

THERMAL DATA

Rthj-case	Thermal Resistance Junction-case Max	2.5	$^\circ\text{C}/\text{W}$
Rthj-amb	Thermal Resistance Junction-ambient Max	100	$^\circ\text{C}/\text{W}$

ELECTRICAL CHARACTERISTICS ($T_{CASE} = 25^\circ\text{C}$ UNLESS OTHERWISE SPECIFIED)

OFF

Symbol	Parameter	Test Conditions	Min.	Typ.	Max.	Unit
$V_{BR(CES)}$	Collector-Emitter Breakdown Voltage	$I_C = 250\ \mu\text{A}$, $V_{GE} = 0$	600			V
I_{CES}	Collector cut-off ($V_{GE} = 0$)	$V_{CE} = \text{Max Rating}$, $T_C = 25^\circ\text{C}$ $V_{CE} = \text{Max Rating}$, $T_C = 125^\circ\text{C}$			50 100	μA μA
I_{GES}	Gate-Emitter Leakage Current ($V_{CE} = 0$)	$V_{GE} = \pm 20\text{V}$, $V_{CE} = 0$			± 100	nA

ON (1)

Symbol	Parameter	Test Conditions	Min.	Typ.	Max.	Unit
$V_{GE(th)}$	Gate Threshold Voltage	$V_{CE} = V_{GE}$, $I_C = 250\ \mu\text{A}$	3		5	V
$V_{CE(sat)}$	Collector-Emitter Saturation Voltage	$V_{GE} = 15\text{V}$, $I_C = 3\ \text{A}$ $V_{GE} = 15\text{V}$, $I_C = 3\ \text{A}$, $T_j = 125^\circ\text{C}$		2.4 1.9	2.8	V V

ELECTRICAL CHARACTERISTICS (CONTINUED)

DYNAMIC

Symbol	Parameter	Test Conditions	Min.	Typ.	Max.	Unit
g_{fs}	Forward Transconductance	$V_{CE} = 25 \text{ V}, I_C = 3 \text{ A}$		2.4		S
C_{ies} C_{oes} C_{res}	Input Capacitance Output Capacitance Reverse Transfer Capacitance	$V_{CE} = 25 \text{ V}, f = 1 \text{ MHz}, V_{GE} = 0$		235 33 6.6		pF pF pF
Q_g Q_{ge} Q_{gc}	Total Gate Charge Gate-Emitter Charge Gate-Collector Charge	$V_{CE} = 480 \text{ V}, I_C = 3 \text{ A},$ $V_{GE} = 15 \text{ V}$		21 6 7.6	27	nC nC nC
I_{CL}	Latching Current	$V_{clamp} = 480 \text{ V}, T_j = 125^\circ\text{C}$ $R_G = 10 \Omega$	12			A

SWITCHING ON

Symbol	Parameter	Test Conditions	Min.	Typ.	Max.	Unit
$t_{d(on)}$ t_r	Turn-on Delay Time Rise Time	$V_{CC} = 480 \text{ V}, I_C = 3 \text{ A}$ $R_G = 10 \Omega, V_{GE} = 15 \text{ V}$		5 11		ns ns
$(di/dt)_{on}$ E_{on}	Turn-on Current Slope Turn-on Switching Losses	$V_{CC} = 480 \text{ V}, I_C = 3 \text{ A}, R_G = 10 \Omega$ $V_{GE} = 15 \text{ V}, T_j = 125^\circ\text{C}$		400 77		A/ μs μJ

SWITCHING OFF

Symbol	Parameter	Test Conditions	Min.	Typ.	Max.	Unit
t_c $t_r(V_{off})$ $t_{d(off)}$ t_f $E_{off(**)}$ E_{ts}	Cross-over Time Off Voltage Rise Time Delay Time Fall Time Turn-off Switching Loss Total Switching Loss	$V_{CC} = 480 \text{ V}, I_C = 3 \text{ A},$ $R_{GE} = 10 \Omega, V_{GE} = 15 \text{ V}$		76 36 53 77 33 100		ns ns ns ns μJ μJ
t_c $t_r(V_{off})$ $t_{d(off)}$ t_f $E_{off(**)}$ E_{ts}	Cross-over Time Off Voltage Rise Time Delay Time Fall Time Turn-off Switching Loss Total Switching Loss	$V_{CC} = 480 \text{ V}, I_C = 3 \text{ A},$ $R_{GE} = 10 \Omega, V_{GE} = 15 \text{ V}$ $T_j = 125^\circ\text{C}$		180 82 58 110 88 165		ns ns ns ns μJ μJ

Note: 1. Pulsed: Pulse duration = 300 μs , duty cycle 1.5 %.
2. Pulse width limited by max. junction temperature.
(**)Losses include Also the Tail (Jedec Standardization)

COLLECTOR-EMITTER DIODE

Symbol	Parameter	Test Conditions	Min.	Typ.	Max.	Unit
I_f I_{fm}	Forward Current Forward Current pulsed				1.5 12	A A
V_f	Forward On-Voltage	$I_f = 1.5 \text{ A}$ $I_f = 1.5 \text{ A}, T_j = 125^\circ\text{C}$		1.6 1.3	2.1	V V
t_{rr} Q_{rr} I_{rrm}	Reverse Recovery Time Reverse Recovery Charge Reverse Recovery Current	$I_f = 1.5 \text{ A}, V_R = 400 \text{ V},$ $T_j = 125^\circ\text{C}, di/dt = 100 \text{ A}/\mu\text{s}$		95 110 2.7		ns nC A

STGD3NB60HD

Thermal Impedance

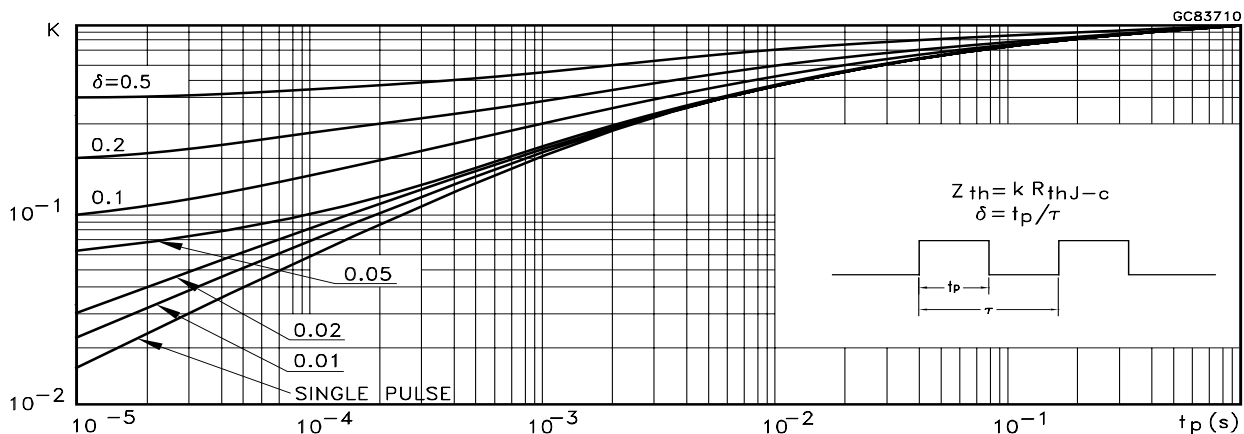

Output Characteristics

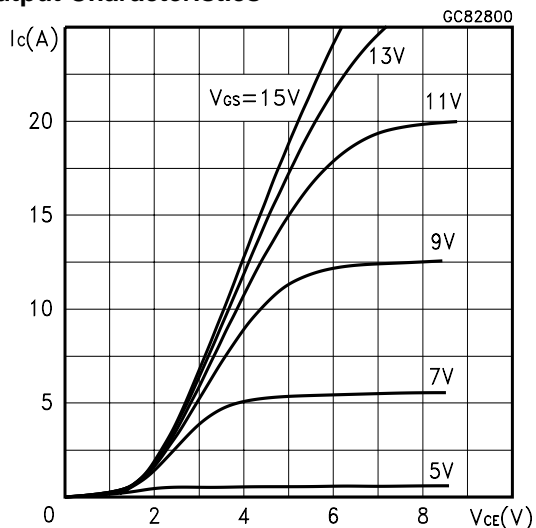

Transfer Characteristics

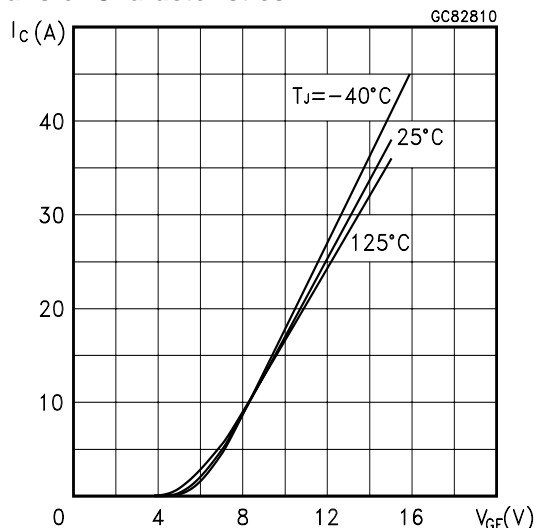

Transconductance

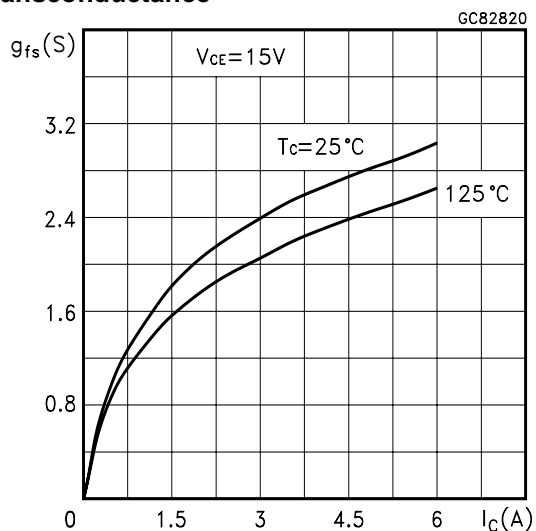

Collector-Emitter On Voltage vs Temperature

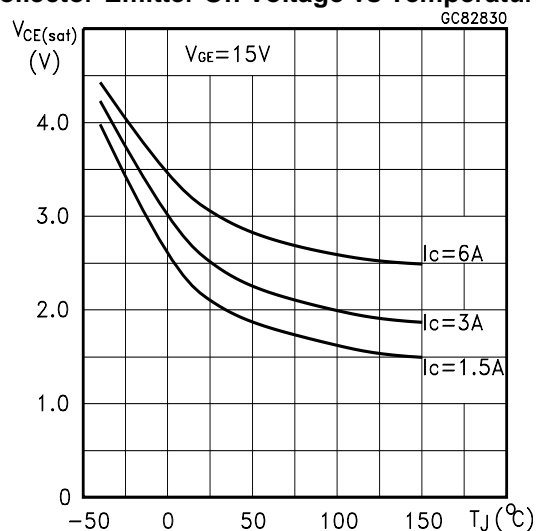

Collector-Emitter On Voltage vs Collector Current

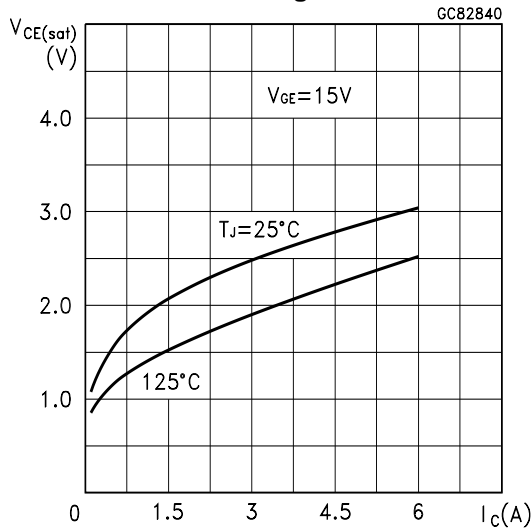

Gate Threshold vs Temperature

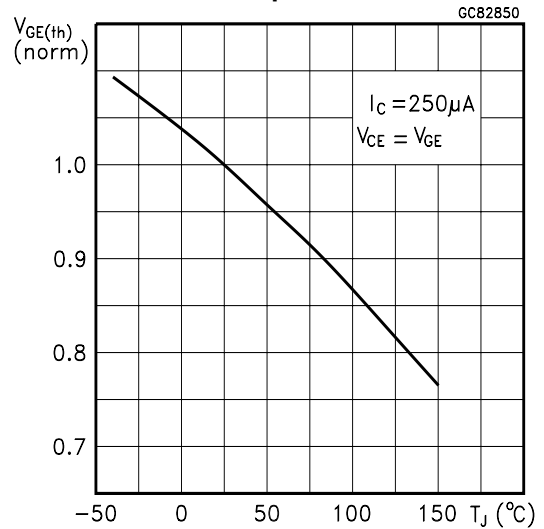

Normalized Breakdown Voltage vs Temperature

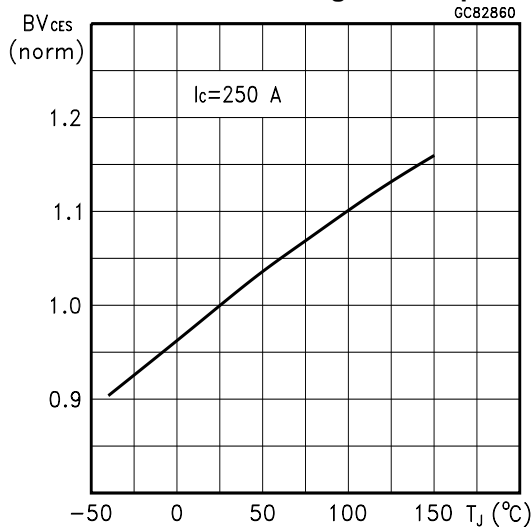

Capacitance Variations

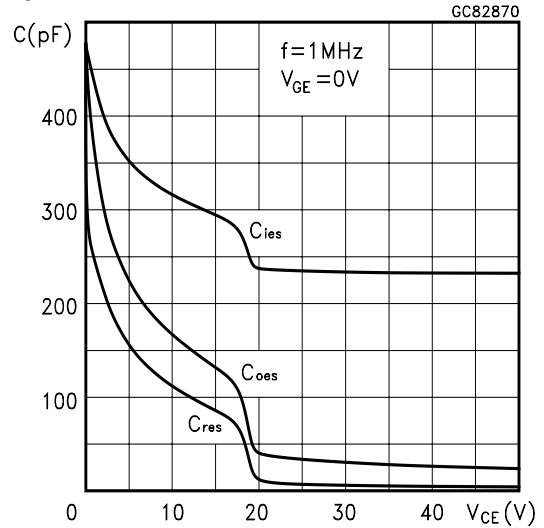

Gate Charge vs Gate-Emitter Voltage

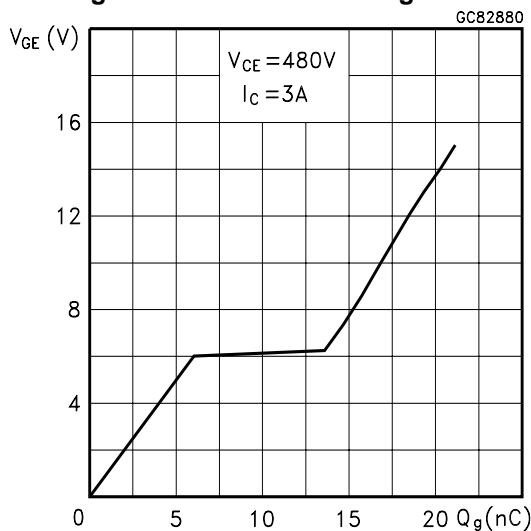

Total Switching Losses vs Gate Resistance

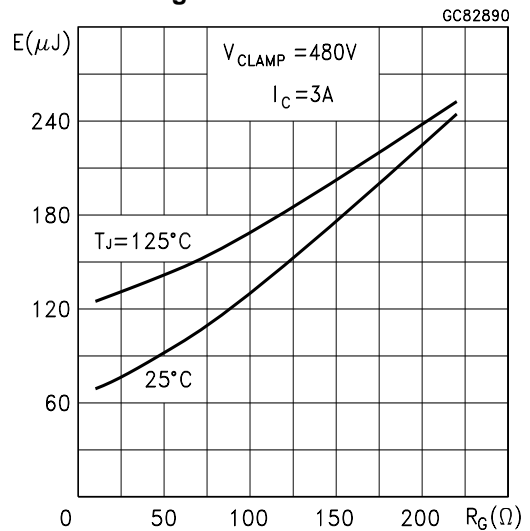

STGD3NB60HD

Total Switching Losses vs Temperature

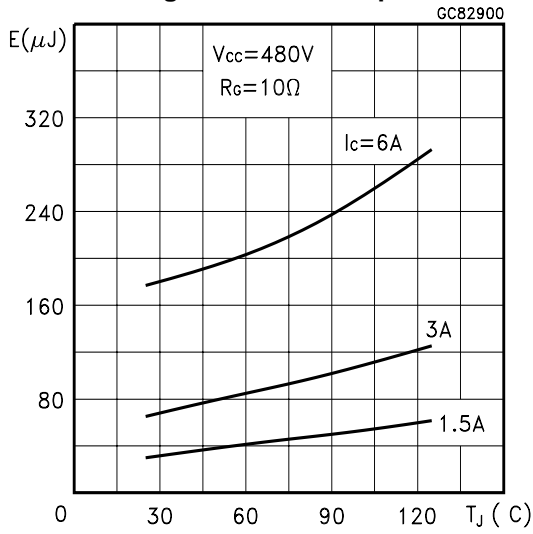

Emitter-collector Diode Characteristics

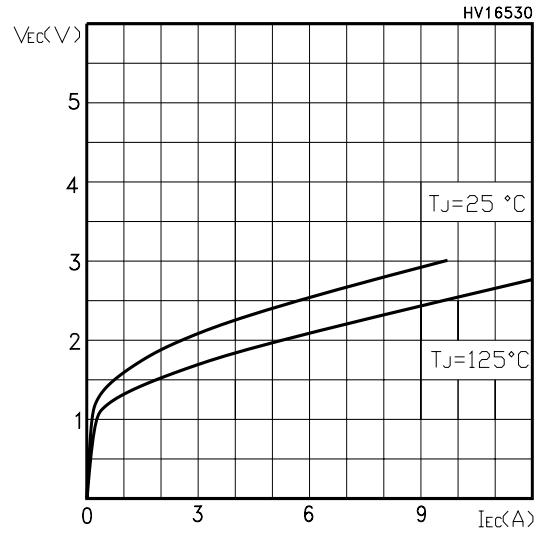

Total Switching Losses vs Collector Current

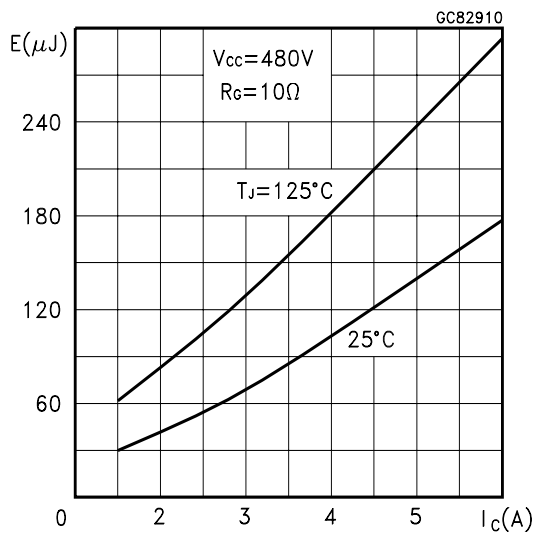

Switching Off Safe Operating Area

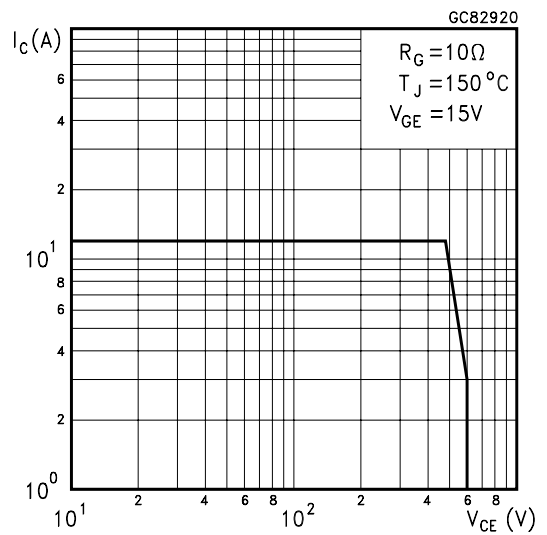

TO-252 (DPAK) MECHANICAL DATA

DIM.	mm			inch		
	MIN.	TYP.	MAX.	MIN.	TYP.	MAX.
A	2.20		2.40	0.087		0.094
A1	0.90		1.10	0.035		0.043
A2	0.03		0.23	0.001		0.009
B	0.64		0.90	0.025		0.035
B2	5.20		5.40	0.204		0.213
C	0.45		0.60	0.018		0.024
C2	0.48		0.60	0.019		0.024
D	6.00		6.20	0.236		0.244
E	6.40		6.60	0.252		0.260
G	4.40		4.60	0.173		0.181
H	9.35		10.10	0.368		0.398
L2		0.8			0.031	
L4	0.60		1.00	0.024		0.039
V2	0°		8°	0°		0°

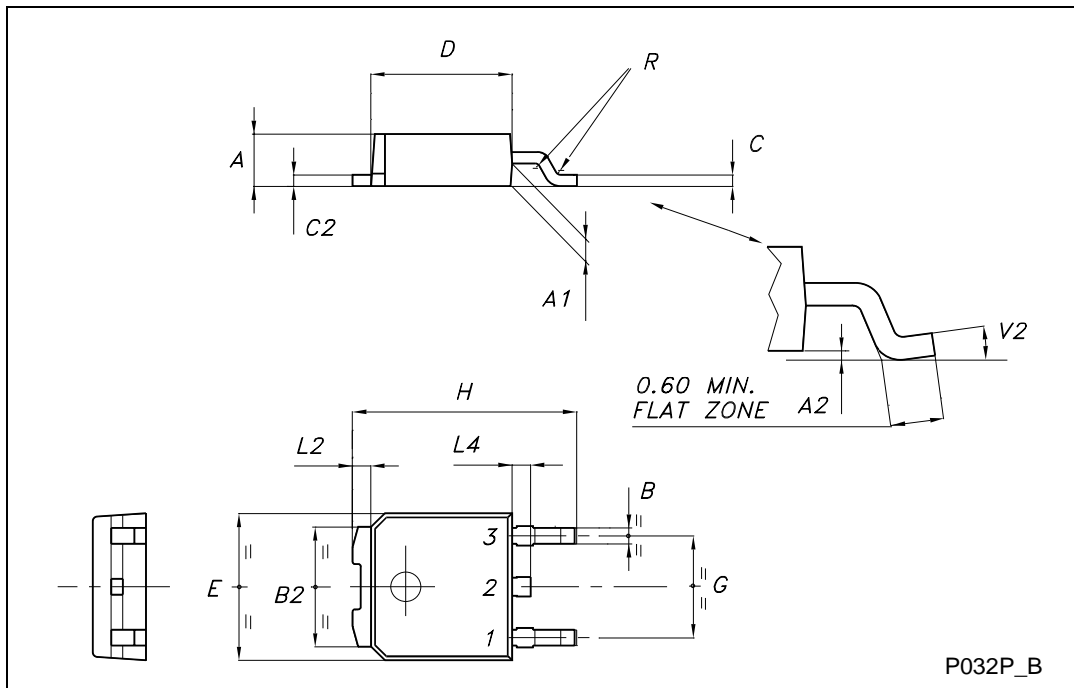

P032P_B

DPAK FOOTPRINT

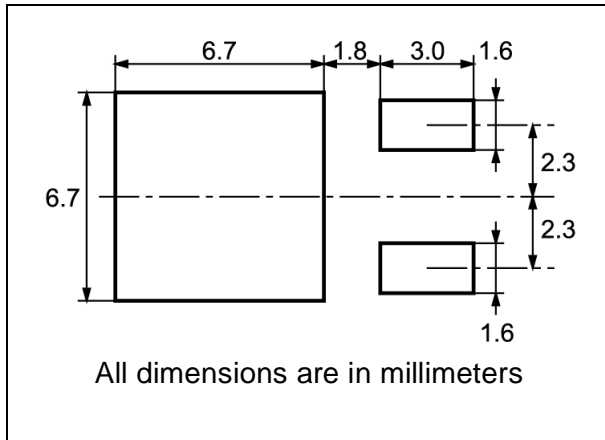

TUBE SHIPMENT (no suffix)*

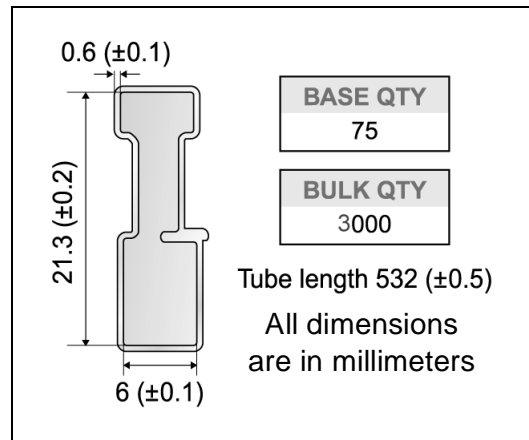

TAPE AND REEL SHIPMENT (suffix "T4")*

40 mm min. Access hole at slot location

Tape slot in core for tape start 2.5mm min. width

Full radius

G measured at hub

REEL MECHANICAL DATA

DIM.	mm		inch	
	MIN.	MAX.	MIN.	MAX.
A		330		12.992
B	1.5		0.059	
C	12.8	13.2	0.504	0.520
D	20.2		0.795	
G	16.4	18.4	0.645	0.724
N	50		1.968	
T		22.4		0.881

BASE QTY	BULK QTY
2500	2500

TAPE MECHANICAL DATA

DIM.	mm		inch	
	MIN.	MAX.	MIN.	MAX.
A0	6.8	7	0.267	0.275
B0	10.4	10.6	0.409	0.417
B1		12.1		0.476
D	1.5	1.6	0.059	0.063
D1	1.5		0.059	
E	1.65	1.85	0.065	0.073
F	7.4	7.6	0.291	0.299
K0	2.55	2.75	0.100	0.108
P0	3.9	4.1	0.153	0.161
P1	7.9	8.1	0.311	0.319
P2	1.9	2.1	0.075	0.082
R	40		1.574	
W	15.7	16.3	0.618	0.641

TOP COVER TAPE

10 pitches cumulative tolerance on tape +/- 0.2 mm

Center line of cavity

User Direction of Feed

FEED DIRECTION

Bending radius R min.

For machine ref. only including draft and radii concentric around B0

Information furnished is believed to be accurate and reliable. However, STMicroelectronics assumes no responsibility for the consequences of use of such information nor for any infringement of patents or other rights of third parties which may result from its use. No license is granted by implication or otherwise under any patent or patent rights of STMicroelectronics. Specifications mentioned in this publication are subject to change without notice. This publication supersedes and replaces all information previously supplied. STMicroelectronics products are not authorized for use as critical components in life support devices or systems without express written approval of STMicroelectronics.

© The ST logo is a registered trademark of STMicroelectronics

© 2003 STMicroelectronics - Printed in Italy - All Rights Reserved
STMicroelectronics GROUP OF COMPANIES

Australia - Brazil - Canada - China - Finland - France - Germany - Hong Kong - India - Israel - Italy - Japan - Malaysia - Malta - Morocco
Singapore - Spain - Sweden - Switzerland - United Kingdom - United States.

© <http://www.st.com>