

DATA SHEET

GDZJ2.0~GDZJ56

AXIAL LEAD ZENER DIODES

VOLTAGE 2.0 to 56 Volts

POWER 500 mWatts

DO-35

Unit: inch (mm)

FEATURES

- Planar Die construction
- 500mW Power Dissipation
- Ideally Suited for Automated Assembly Processes
- Pb free product are available : 99% Sn above can meet Rohs environment substance directive request

MECHANICAL DATA

- Case: Molded Glass DO-35
- Terminals: Solderable per MIL-STD-202G, Method 208
- Polarity: See Diagram Below
- Approx. Weight: 0.13 grams
- Mounting Position: Any
- Ordering information: Suffix : " -35 " to order DO-35 Package
- Packing information
 - B - 2K per Bulk box
 - T/R - 10K per 13" plastic Reel
 - T/B - 5K per horiz. tape & Ammo box

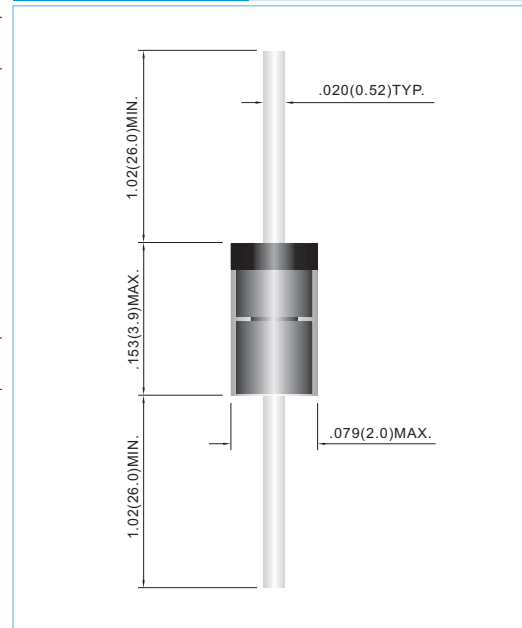

MAXIMUM RATINGS AND ELECTRICAL CHARACTERISTICS

Parameter	Symbol	Value	Units
Power Dissipation at Tamb = 25 °C	P _{TO T}	500	mW
Junction Temperature	T _J	175	°C
Storage Temperature Range	T _S	-65 to +175	°C

Valid provided that leads at a distance of 10mm from case are kept at ambient temperature.

Parameter	Symbol	Min.	Typ.	Max.	Units
Thermal Resistance Junction to Ambient Air	R _{thA}	—	—	0.3	K / W
Forward Voltage at I _F = 100mA	V _F	—	—	1	V

Valid provided that leads at a distance of 10mm from case are kept at ambient temperature.

Part Number	CLASS	Vz @ Izt		IZ (mA)	VR (V)	IR(μA) MAX	Izt (mA)	ZzT(Ω) MAX	Izk (mA)	Zzk(Ω) MAX	MARKING CODE
		Min. V	Max. V								
GDZJ 2.0	A	1.88	2.10	5	0.5	120	5	100	0.5	1000	Z2A0
	B	2.02	2.20								Z2B0
GDZJ 2.2	A	2.12	2.30	5	0.7	100	5	100	0.5	1000	Z2A2
	B	2.22	2.41								Z2B2
GDZJ 2.4	A	2.33	2.52	5	1.0	120	5	100	0.5	1000	Z2A4
	B	2.43	2.63								Z2B4
GDZJ 2.7	A	2.54	2.75	5	1.0	100	5	110	0.5	1000	Z2A7
	B	2.69	2.91								Z2B7
GDZJ 3.0	A	2.85	3.07	5	1.0	50	5	120	0.5	1000	Z3A0
	B	3.01	3.22								Z3B0
GDZJ 3.3	A	3.16	3.38	5	1.0	20	5	120	0.5	1000	Z3A3
	B	3.32	3.53								Z3B3
GDZJ 3.6	A	3.455	3.695	5	1.0	10	5	100	1	1000	Z3A6
	B	3.60	3.845								Z3B6
GDZJ 3.9	A	3.74	4.01	5	1.0	5	5	100	1	1000	Z3A9
	B	3.89	4.16								Z3B9
GDZJ 4.3	A	4.04	4.29	5	1.0	5	5	100	1	1000	Z4A3
	B	4.17	4.43								Z4B3
	C	4.30	4.57								Z4C3
GDZJ 4.7	A	4.44	4.68	5	1.0	5	5	90	1	900	Z4A7
	B	4.55	4.80								Z4B7
	C	4.68	4.93								Z4C7
GDZJ 5.1	A	4.81	5.07	5	1.5	5	5	80	1	800	Z5A1
	B	4.94	5.20								Z5B1
	C	5.09	5.37								Z5C1
GDZJ 5.6	A	5.28	5.55	5	2.5	5	5	60	1	500	Z5A6
	B	5.45	5.73								Z5B6
	C	5.61	5.91								Z5C6
GDZJ 6.2	A	5.78	6.09	5	3.0	5	5	60	1	300	Z6A2
	B	5.96	6.27								Z6B2
	C	6.12	6.44								Z6C2
GDZJ 6.8	A	6.29	6.63	5	3.5	2	5	20	0.5	150	Z6A8
	B	6.49	6.83								Z6B8
	C	6.66	7.01								Z6C8
GDZJ 7.5	A	6.85	7.22	5	4.0	0.5	5	20	0.5	120	Z7A5
	B	7.07	7.45								Z7B5
	C	7.29	7.67								Z7C5
GDZJ 8.2	A	7.53	7.92	5	5.0	0.5	5	20	0.5	120	Z8A2
	B	7.78	8.19								Z8B2
	C	8.03	8.45								Z8C2
GDZJ 9.1	A	8.29	8.73	5	6.0	0.5	5	25	0.5	120	Z9A1
	B	8.57	9.01								Z9B1
	C	8.83	9.30								Z9C1
GDZJ 10	A	9.12	9.59	5	7.0	0.2	5	30	0.5	120	Z10A
	B	9.41	9.90								Z10B
	C	9.70	10.20								Z10C
	D	9.94	10.44								Z11D
GDZJ 11	A	10.18	10.71	5	8.0	0.2	5	30	0.5	120	Z11A
	B	10.50	11.05								Z11B
	C	10.82	11.38								Z11C

Part Number	CLASS	Vz @ IZT		IZ (mA)	VR (V)	IR(μA) MAX	Izt (mA)	ZzT(Ω) MAX	Izk (mA)	Zzk(Ω) MAX	MARKING CODE
		Min. V	Max. V								
GDZJ 12	A	11.13	11.71	5	9.0	0.2	5	30	0.5	110	Z12A
	B	11.44	12.03								Z12B
	C	11.74	12.35								Z12C
GDZJ 13	A	12.11	12.75	5	10	0.2	5	35	0.5	110	Z13A
	B	12.55	13.21								Z13B
	C	12.99	13.66								Z13C
GDZJ 15	A	13.44	14.13	5	11	0.2	5	40	0.5	110	Z15A
	B	13.89	14.62								Z15B
	C	14.35	15.09								Z15C
GDZJ 16	A	14.80	15.57	5	12	0.2	5	40	0.5	150	Z16A
	B	15.25	16.04								Z16B
	C	15.69	16.51								Z16C
GDZJ 18	A	16.22	17.06	5	13	0.2	5	45	0.5	150	Z18A
	B	16.82	17.70								Z18B
	C	17.42	18.33								Z18C
GDZJ 20	A	18.02	18.96	5	15	0.2	5	55	0.5	200	Z20A
	B	18.63	19.59								Z20B
	C	19.23	20.22								Z20C
	D	19.72	20.72								Z20D
GDZJ 22	A	20.15	21.20	5	17	0.2	5	30	0.5	200	Z22A
	B	20.64	21.71								Z22B
	C	21.08	22.17								Z22C
	D	21.52	22.63								Z22D
GDZJ 24	A	22.05	23.18	5	19	0.2	5	35	0.5	200	Z24A
	B	22.61	23.77								Z24B
	C	23.12	24.31								Z24C
	D	23.63	24.85								Z24D
GDZJ 27	A	24.26	25.52	5	21	0.2	5	45	0.5	250	Z27A
	B	24.97	26.26								Z27B
	C	25.63	26.95								Z27C
	D	26.29	27.64								Z27D
GDZJ 30	A	26.99	28.39	5	23	0.2	5	55	0.5	250	Z30A
	B	27.70	29.13								Z30B
	C	28.36	29.82								Z30C
	D	29.02	30.51								Z30D
GDZJ 33	A	29.68	31.22	5	25	0.2	5	65	0.5	250	Z33A
	B	30.32	31.88								Z33B
	C	30.90	32.50								Z33C
	D	31.49	33.11								Z33D
GDZJ 36	A	32.14	33.79	5	27	0.2	5	75	0.5	250	Z36A
	B	32.79	34.49								Z36B
	C	33.40	35.13								Z36C
	D	34.01	35.77								Z36D
GDZJ 39	A	34.68	36.47	5	30	0.2	5	85	0.5	250	Z39A
	B	35.36	37.19								Z39B
	C	36.00	37.85								Z39C
	D	36.63	38.52								Z39D
GDZJ 43		40.00	45.00	5	33	0.2	5	90	--	--	Z41
GDZJ 47		44.00	49.00	5	36	0.2	5	90	--	--	Z43
GDZJ 51		48.00	54.00	5	39	0.2	5	110	--	--	Z47
GDZJ 56		53.00	60.00	5	43	0.2	5	110	--	--	Z51

Typical Characteristics ($T_{amb} = 25\text{ }^{\circ}\text{C}$ unless otherwise specified)

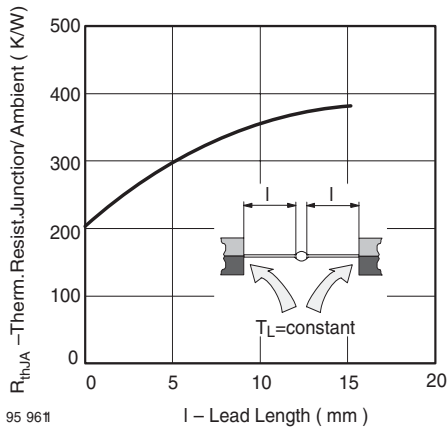

Fig. 1 Thermal Resistance vs. Lead Length

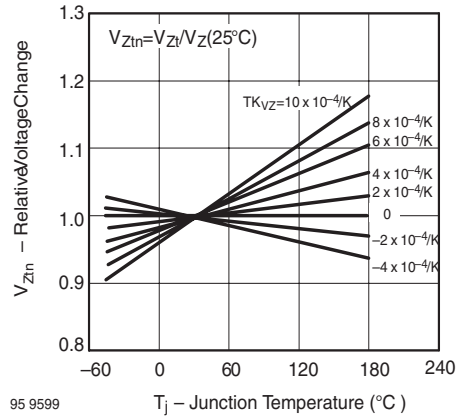

Fig. 4 Typical Change of Working Voltage vs. Junction Temperature

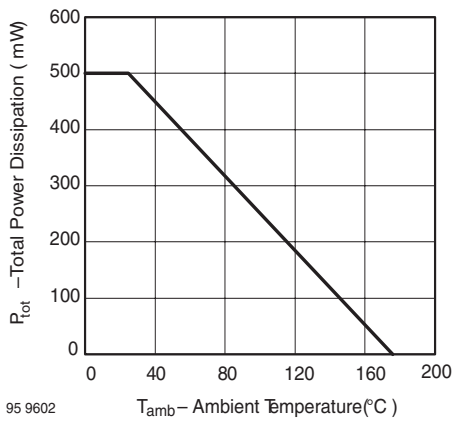

Fig. 2 Total Power Dissipation vs. Ambient Temperature

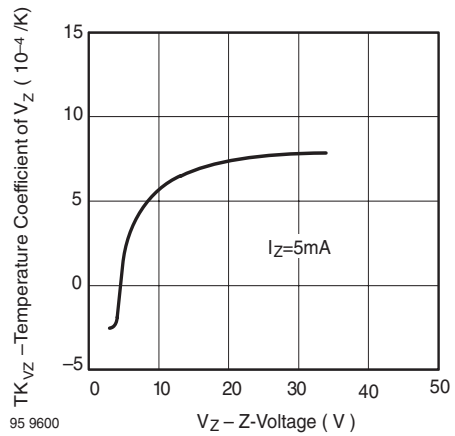

Fig. 5 Temperature Coefficient of V_Z vs. Z-Voltage

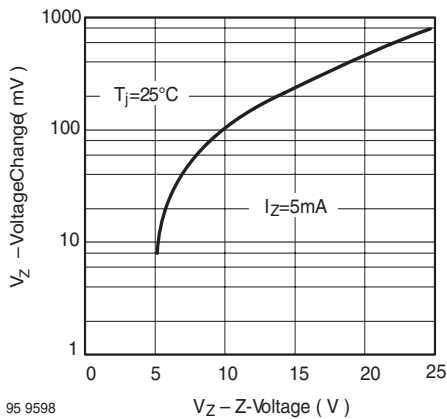

Fig. 3 Typical Change of Working Voltage under Operating Conditions at $T_{amb}=25\text{ }^{\circ}\text{C}$

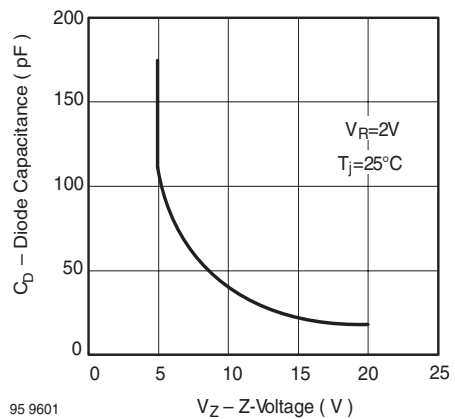

Fig. 6 Diode Capacitance vs. Z-Voltage

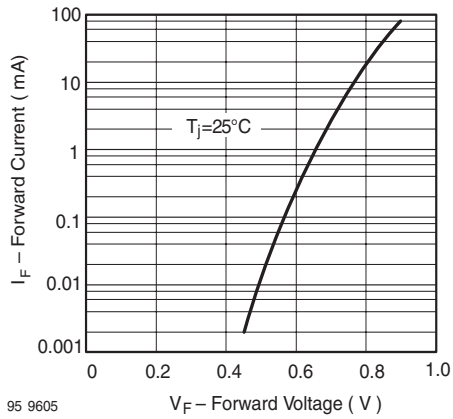

Fig. 7 Forward Current vs. Forward Voltage

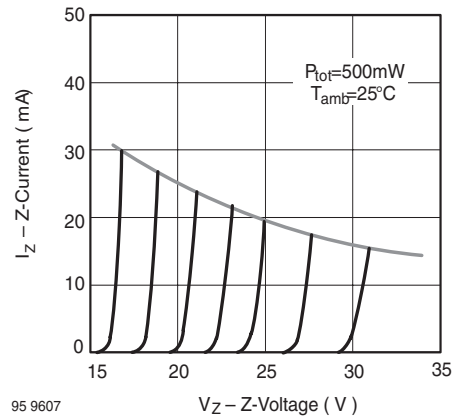

Fig. 9 Z-Current vs. Z-Voltage

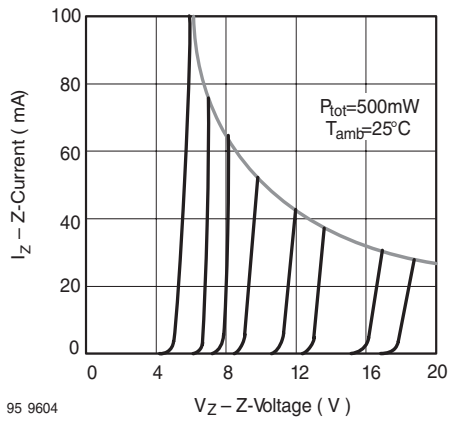

Fig. 8 Z-Current vs. Z-Voltage

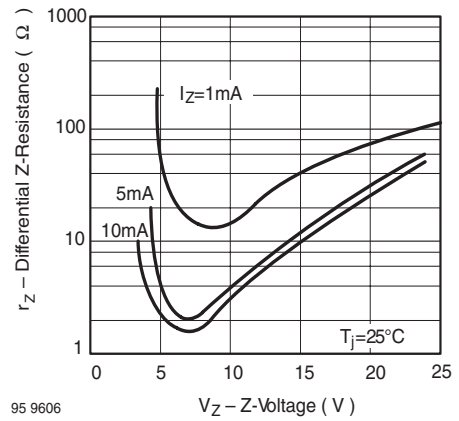

Fig. 10 Differential Z-Resistance vs. Z-Voltage

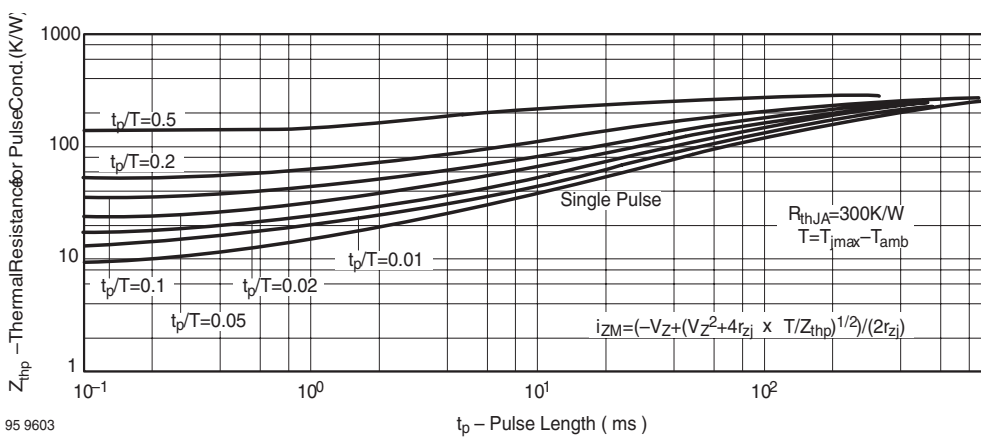

Fig. 11 Thermal Response