

# GL390/GL390V

## Thin Bow Type Resin Mold Package Infrared Emitting Diodes

### ■ Features

- Thin bow type resin mold package  
(Resin area : 2.0 x 3.1 x 5.2 mm)
- Low peak forward voltage (**GL390V**)  
 $V_{FM}$  : TYP. 1.9V at  $I_{FM}=0.5A$

### ■ Applications

- Cameras
- Infrared remote controllers

### ■ Outline Dimensions

(Unit : mm)

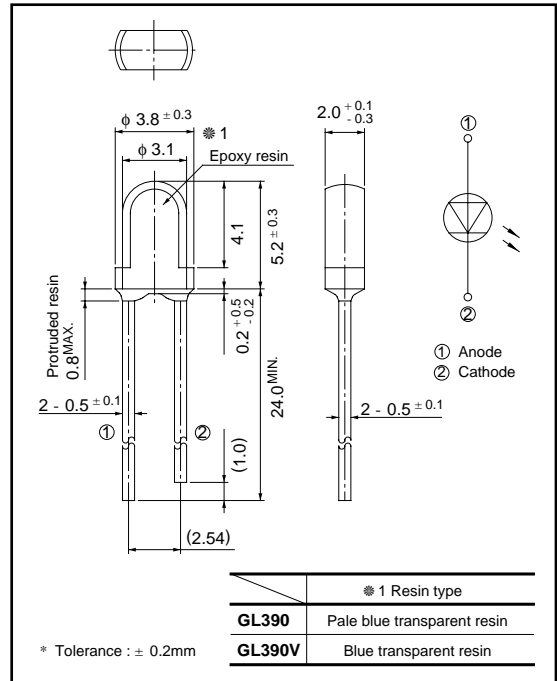

### ■ Model Lineup

Model	GL390	GL390V
Radiant intensity (mW/sr)	TYP. 13	TYP. 16
Half intensity angle (°)	TYP. ± 18	

### ■ Absolute Maximum Ratings

(Ta=25°C)

Parameter	Symbol	Rating	Unit
Forward current	$I_F$	60	mA
*1 Peak forward current	$I_{FM}$	1	A
Reverse voltage	$V_R$	6	V
Power dissipation	P	150	mW
Operating temperature	$T_{opr}$	- 25 to 85	°C
Storage temperature	$T_{stg}$	- 40 to 85	°C
*2 Soldering temperature	$T_{sol}$	260	°C

\*1 Pulse width ≤ 100μs, Duty ratio=0.01

\*2 For 3 seconds at the position of 2.6 mm from the resin edge

**Electro-optical Characteristics**

(Ta=25°C)

Parameter	Symbol	Conditions	MIN.	TYP.	MAX.	Unit
Forward voltage	$V_F$	$I_F = 50\text{mA}$	-	1.3	1.5	V
Peak forward voltage	<b>GL390</b>	$I_{FM} = 0.5\text{A}$	-	2.2	3.5	V
	<b>GL390V</b>		-	1.9	3.0	
Reverse current	$I_R$	$V_R = 3\text{V}$	-	-	10	$\mu\text{A}$
*3 Radiant intensity	<b>GL390</b>	$I_F = 50\text{mA}$	7	13	-	mW/sr
	<b>GL390V</b>		9	16	-	
Peak emission wavelength	$\lambda_P$	$I_F = 5\text{mA}$	-	950	-	nm
Half intensity wavelength	$\Delta\lambda$	$I_F = 5\text{mA}$	-	45	-	nm
Terminal capacitance	<b>GL390</b>	$V_R = 0\text{ f} = 1\text{MHz}$	-	70	-	pF
	<b>GL390V</b>		-	50	-	
Response frequency	$f_c$		-	300	-	kHz
Half intensity angle	$\Delta\theta$	$I_F = 20\text{mA}$	-	$\pm 18$	-	°

\*3  $I_E$  : Value obtained by converting the value in power of radiant fluxes emitted at the solid angle of 0.01 sr (steradian) in the direction of mechanical axis of the lens portion into 1 sr or all those emitted from the light emitting diode.

**Fig. 1 Forward Current vs. Ambient Temperature**

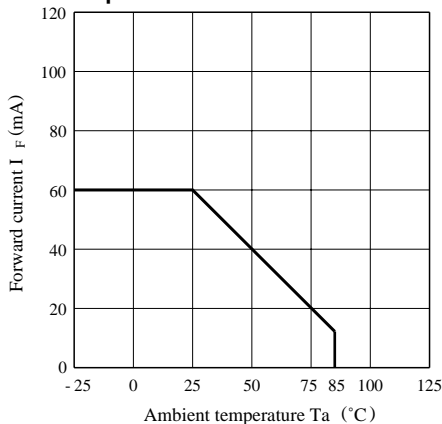

**Fig. 2 Peak Forward Current vs. Duty Ratio**

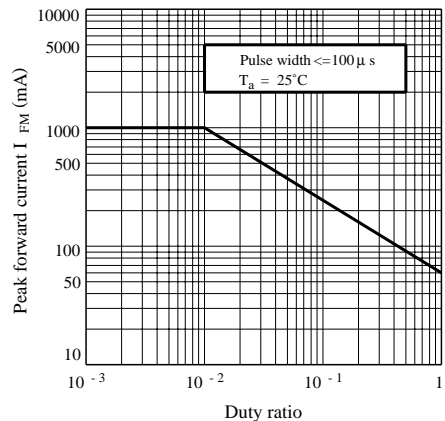

Fig. 3 Spectral Distribution

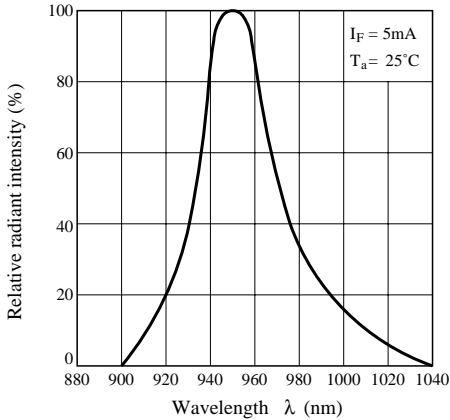

Fig. 4 Peak Emission Wavelength vs. Ambient Temperature

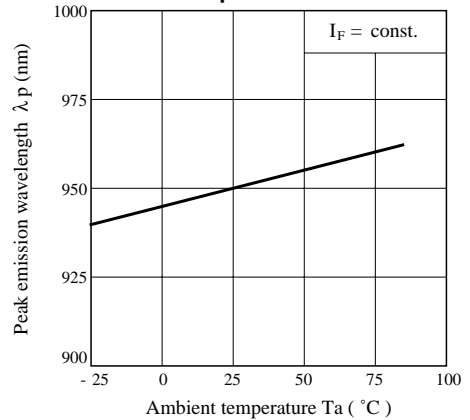

Fig. 5-1 Forward Current vs. Forward Voltage (GL390)

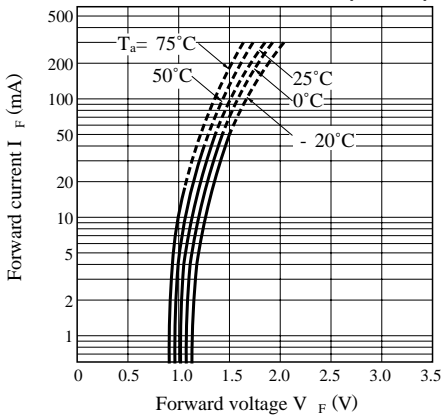

Fig. 5-2 Forward Current vs. Forward Voltage (GL390V)

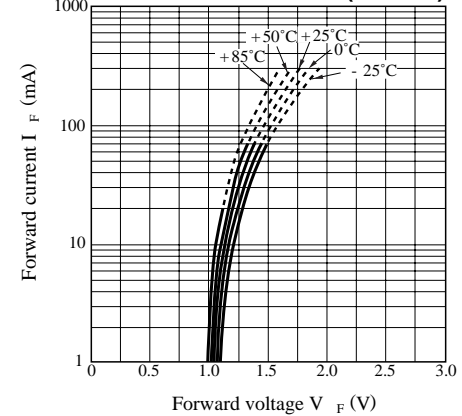

Fig. 6 Relative Radiant Flux vs. Ambient Temperature

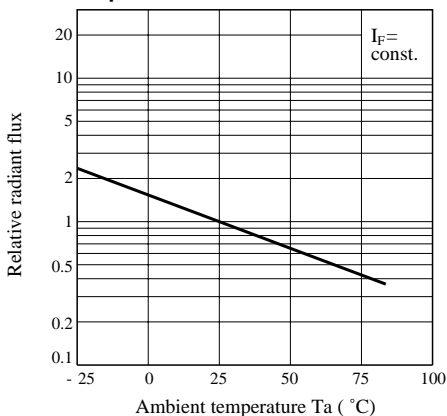

Fig. 7 Radiant Intensity vs. Forward Current

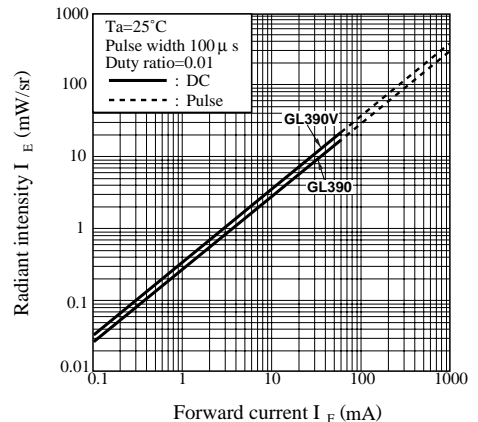

Fig. 8-1 Radiation Diagram (Horizontal Direction)

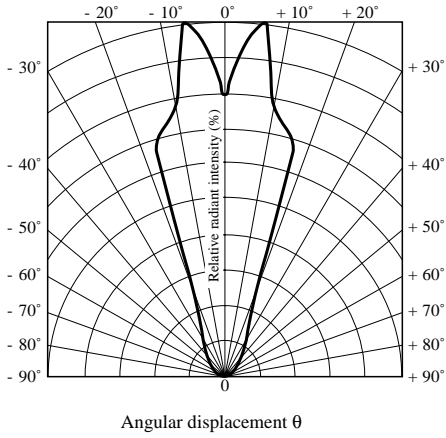
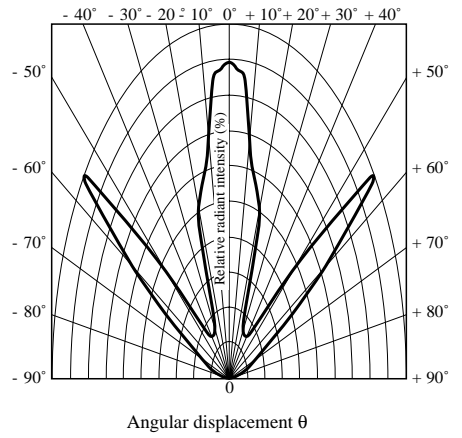

Fig. 8-2 Radiation Diagram (Vertical Direction)



● Please refer to the chapter "Precautions for Use". (Page 78 to 93)