

GL8□□5 series

1.9X3.9mm, Rectangle Type, Milky Diffusion, Dichromatic LED Lamps for Indicator

Outline Dimensions

(Unit : mm)

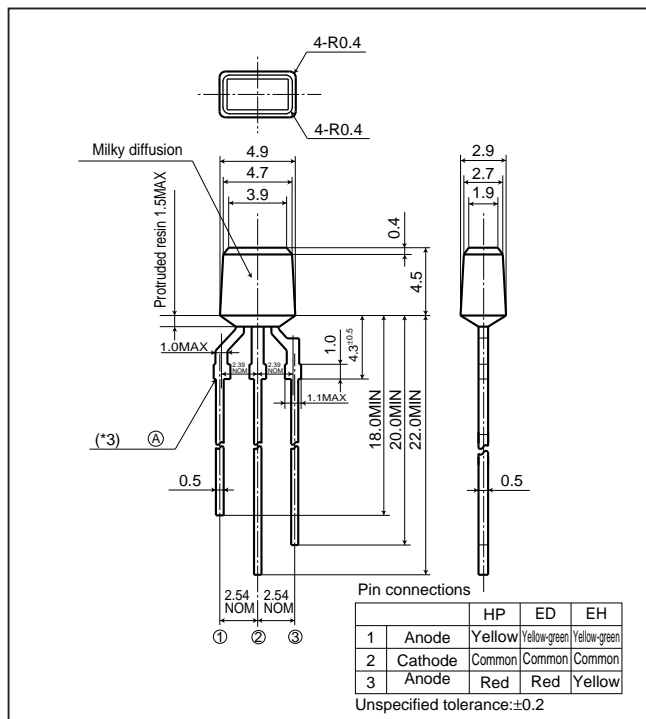

Absolute Maximum Ratings

(T_a=25°C)

Model No.	Radiation color	Radiation material	Power dissipation P ^{*1} (mW)	Forward current I _F (mA)	Peak forward current I _{FM} ^{*2} (mA)	Derating factor (mA/°C)		Reverse voltage V _R (V)	Operating temperature T _{opr} (°C)	Storage temperature T _{stg} (°C)	Soldering temperature T _{sol} ^{*3} (°C)
						DC	Pulse				
GL8ED5	Yellow-green	GaP	84	30	50	0.40	0.67	5	-25 to +85	-25 to +100	260
	Red	GaAsP on GaP	84	30	50	0.40	0.67	5			
GL8EH5	Yellow-green	GaP	84	30	50	0.40	0.67	5	-25 to +85	-25 to +100	260
	Yellow	GaAsP on GaP	84	30	50	0.40	0.67	5			
GL8HP5	Yellow	GaAsP on GaP	50	20	50	0.27	0.67	5	-25 to +85	-25 to +100	260
	Red	GaP	35	15	50	0.27	0.67	5			

*1 The value is specified under the condition that either color is lightened separately. When the both diodes are lightened simultaneously, the power dissipation of each diode should be less than the half of the value specified in this table.

*2 Duty ratio=1/10, Pulse width=0.1ms

*3 5s or less (At the position of 1.6mm or more from the bottom face of resin package)

Electro-optical Characteristics

(T_a=25°C)

Lens type	Model No.	Radiation color	Forward voltage V _F (V)		Peak emission wavelength λ _p (nm)		Luminous intensity I _v (mcd)		Spectrum radiation bandwidth Δλ(nm)		Reverse current I _R (μA)		Terminal capacitance C _t (pF)		Page for characteristics diagrams
			TYP	MAX	TYP	I _F (mA)	TYP	I _F (mA)	TYP	I _F (mA)	MAX	V _R (V)	TYP	(MHz)	
Milky diffusion	GL8ED5	Yellow-green	2.1	2.8	565	20	10.0	20	30	20	10	4	35	1	→
		Red	2.0	2.8	635	20	6.5	20	35	20	10	4	20	1	→
	GL8EH5	Yellow-green	2.1	2.8	565	20	15.0	20	30	20	10	4	35	1	→
		Yellow	2.0	2.8	585	20	13.0	20	35	20	10	4	30	1	→
	GL8HP5	Yellow	1.9	2.5	585	10	3.0	10	30	10	10	4	35	1	→
		Red	1.9	2.3	695	10	1.5	10	100	10	10	4	55	1	→

(Notice) • In the absence of confirmation by device specification sheets, SHARP takes no responsibility for any defects that may occur in equipment using any SHARP devices shown in catalogs, data books, etc. Contact SHARP in order to obtain the latest device specification sheets before using any SHARP device.
 (Internet) • Data for sharp's optoelectronic/power device is provided for internet. (Address <http://www.sharp.co.jp/ecg/>)

LED Lamp Characteristics Diagrams

PR series

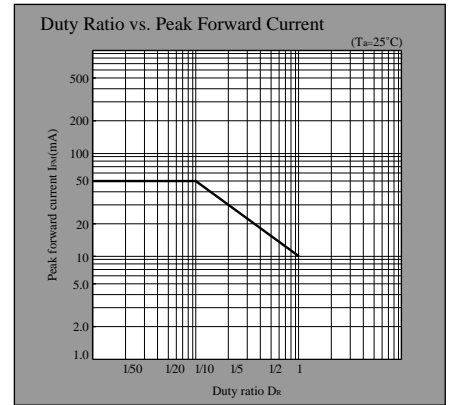
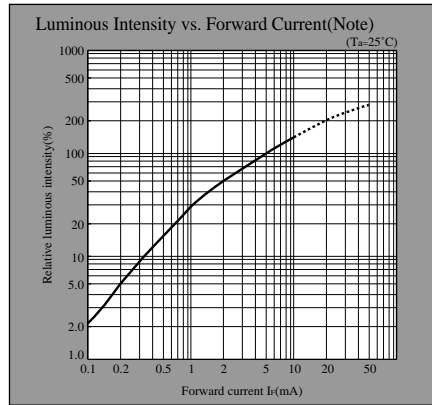
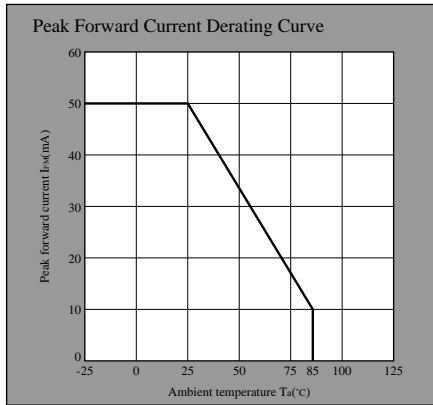
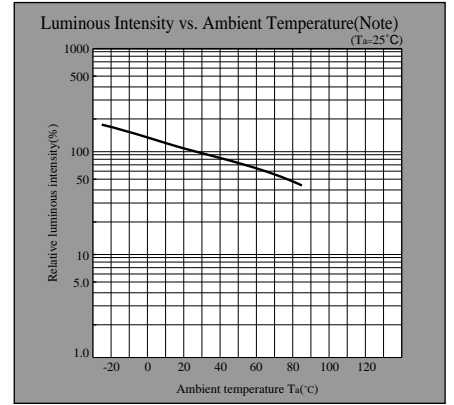
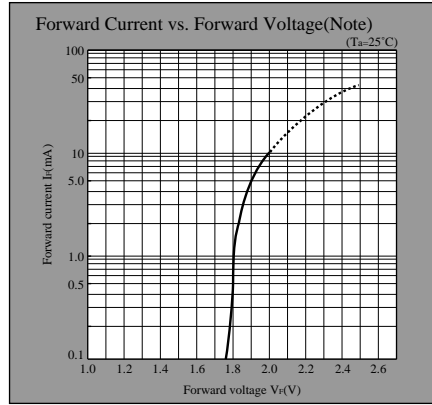
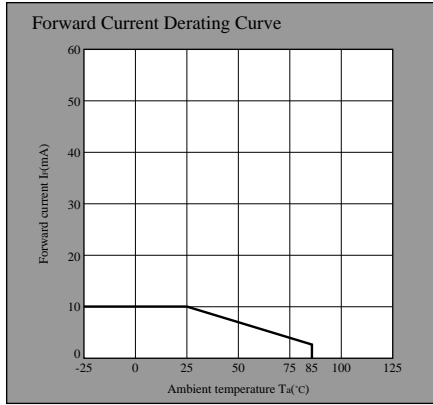

HD series

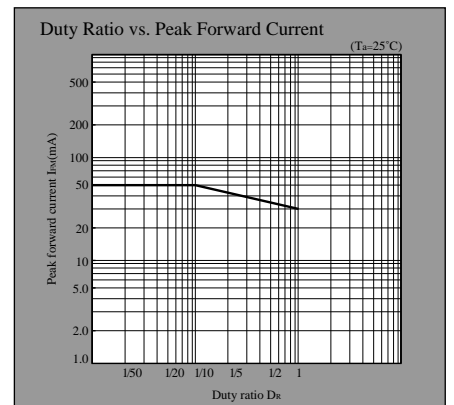
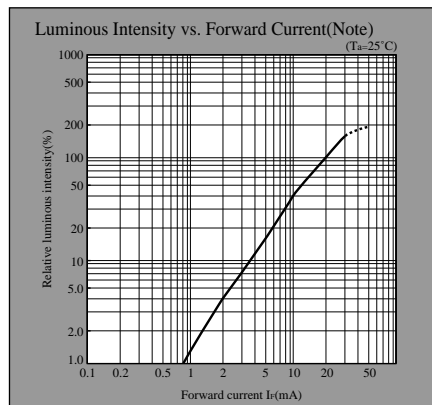
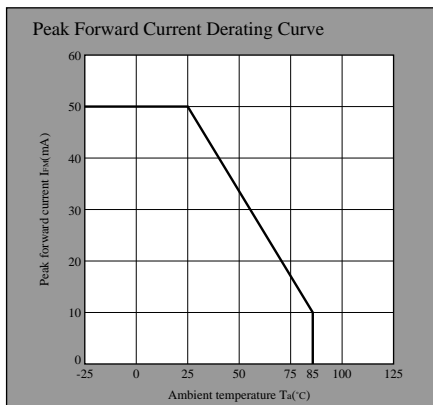
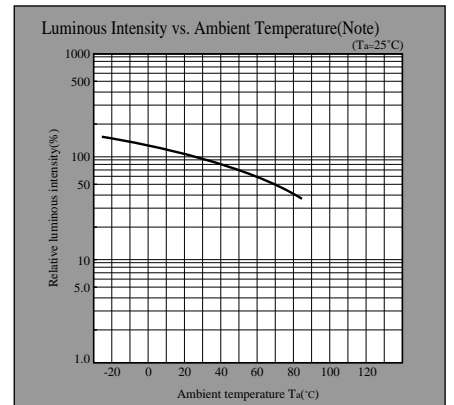
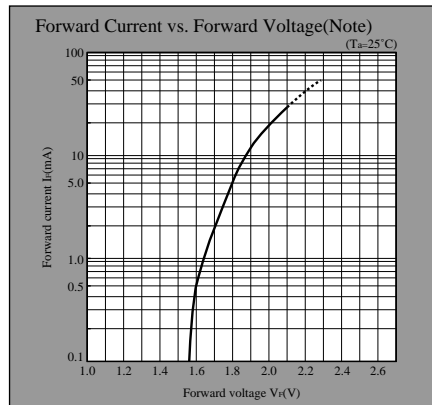
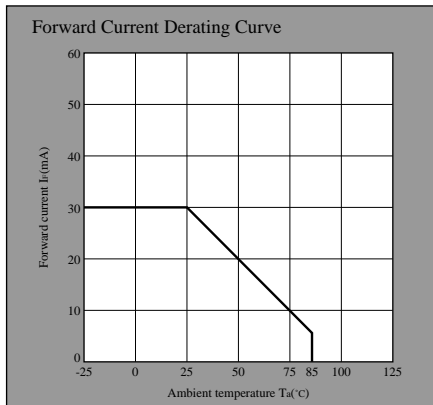

Note) Characteristics shown in diagrams are typical values. (not assurance value)

- (Notice) • In the absence of confirmation by device specification sheets, SHARP takes no responsibility for any defects that may occur in equipment using any SHARP devices shown in catalogs, data books, etc. Contact SHARP in order to obtain the latest device specification sheets before using any SHARP device.
- (Internet) • Data for sharp's optoelectronic/power device is provided for internet.(Address <http://www.sharp.co.jp/ecg/>)

Forward Current Derating Curve

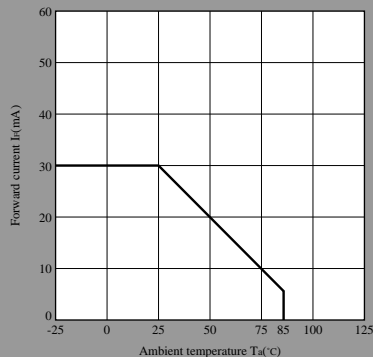

Forward Current vs. Forward Voltage(Note)

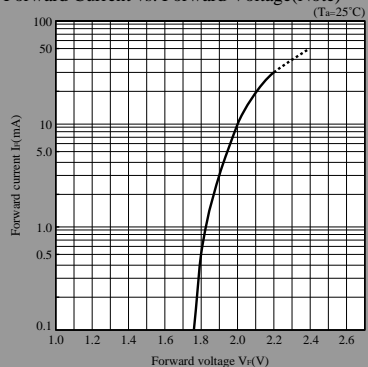

Luminous Intensity vs. Ambient Temperature(Note)

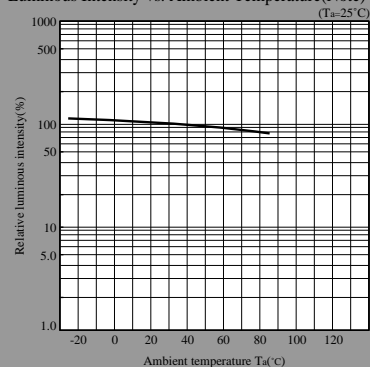

Peak Forward Current Derating Curve

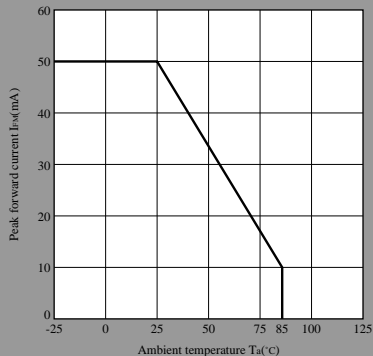

Luminous Intensity vs. Forward Current(Note)

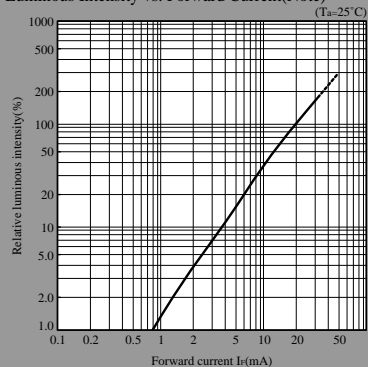

Duty Ratio vs. Peak Forward Current

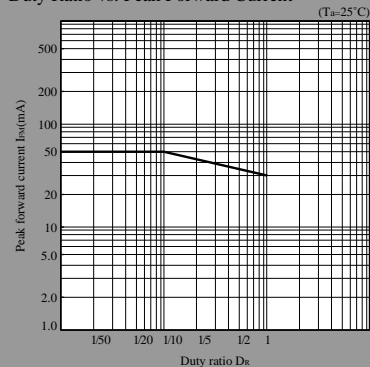

Note) Characteristics shown in diagrams are typical values. (not assurance value)

HY series

Forward Current Derating Curve

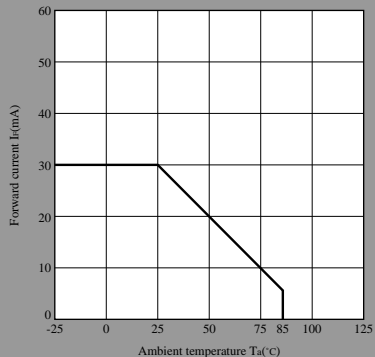

Forward Current vs. Forward Voltage(Note)

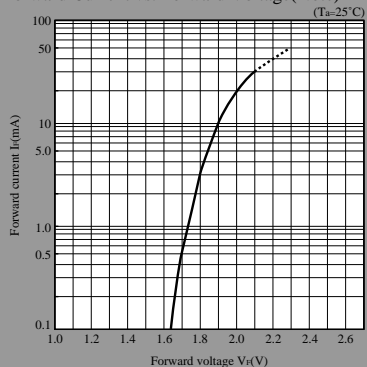

Luminous Intensity vs. Ambient Temperature(Note)

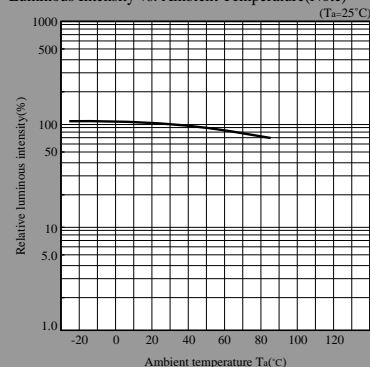

Peak Forward Current Derating Curve

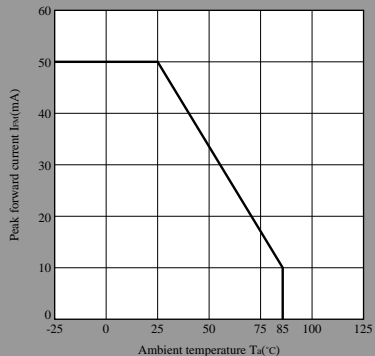

Luminous Intensity vs. Forward Current(Note)

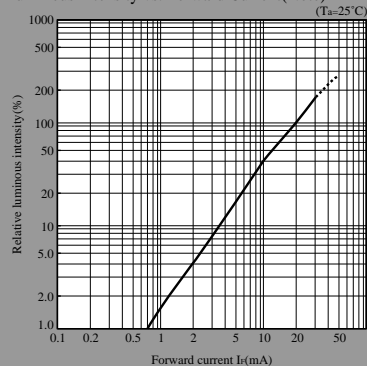

Duty Ratio vs. Peak Forward Current

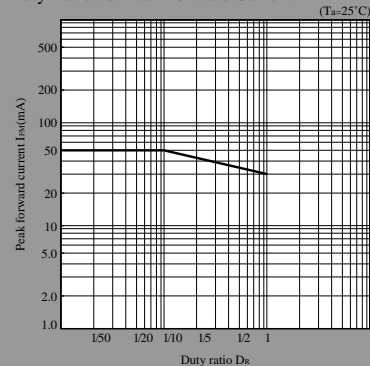

Note) Characteristics shown in diagrams are typical values. (not assurance value)