

ESD Protection Diode Array

Features

- Transient protection for data lines as per **IEC 61000 - 4 - 2 (ESD) 15 kV (air), 8 kV (contact), IEC 61000 - 4 - 5 (Lightning) 12 A (tp = 8/20 μs)**
- Small package for use in portable electronics
- Bidirectional protection of 4 I/O lines
- Unidirectional protection of 5 I/O lines
- Low leakage current
- Ideal for cellular handsets, cordless phones, notebooks, handhelds and digital cameras

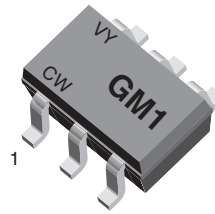

18538-2

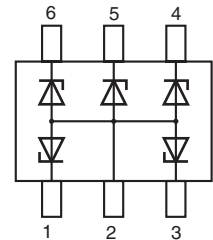

VY - V = Vishay
Y = year, is variable for digit from 0 to 9
(e.g. 4 = 2004, 5 = 2005)

CW = Calendar Week, is variable for number from 01 to 52

GM1 = code for GMF05C

Mechanical Data

Case: SOT-363 Plastic case

Molding Compound Flammability Rating:

UL 94 V-0

Terminals: High temperature soldering guaranteed:

260 °C/10 sec. at terminals

Weight: approx. 6.0 mg

Parts Table

Part	Ordering code	Marking	Remarks
GMF05C	GMF05C-GS08	GM1	Tape and Reel

Absolute Maximum Ratings

Ratings at 25 °C, ambient temperature unless otherwise specified

Parameter	Test condition	Symbol	Value	Unit
Peak pulse power	8/20 μs waveform	P_{ppm}	200	W
Peak pulse current	8/20 μs waveform	I_{pp}	12	A

Thermal Characteristics

Ratings at 25 °C, ambient temperature unless otherwise specified

Parameter	Test condition	Symbol	Value	Unit
Operating temperature		T_j	- 55 to + 125	°C
Storage temperature		T_{STG}	- 55 to + 150	°C

Electrical Characteristics

Ratings at 25 °C, ambient temperature unless otherwise specified

Parameter	Test condition	Symbol	Min	Typ.	Max	Unit
Reverse stand-off voltage		V_{RWM}			5	V
Reverse breakdown voltage	$I_t = 1 \text{ mA}$	V_{BR}	6			V
Reverse leakage current	$V_{RWM} = 5 \text{ V}$	I_R			1	μA
Clamping voltage	$I_{PP} = 1 \text{ A}$, 8/20 μs waveform	V_C			9.5	V
	$I_{PP} = 12 \text{ A}$, 8/20 μs waveform	V_C			12.5	V
Peak forward voltage	$I_F = 1 \text{ A}$, 8/20 μs waveform	V_F		1.5		V
Junction capacitance between I/O pins and Gnd	$V_R = 0 \text{ V}$, $f = 1 \text{ MHz}$	C_j			150	pF

Typical Characteristics ($T_{amb} = 25 \text{ }^\circ\text{C}$ unless otherwise specified)

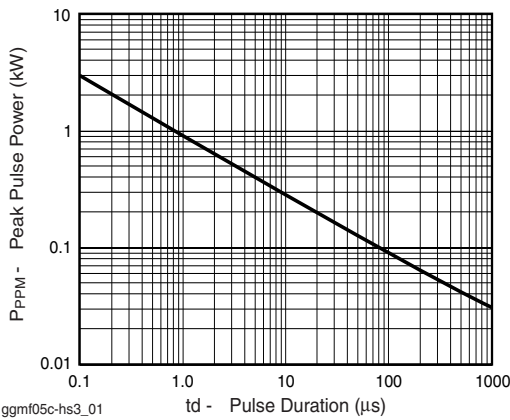

Figure 1. Non -Repetitive Peak Pulse Power vs. Pulse Time

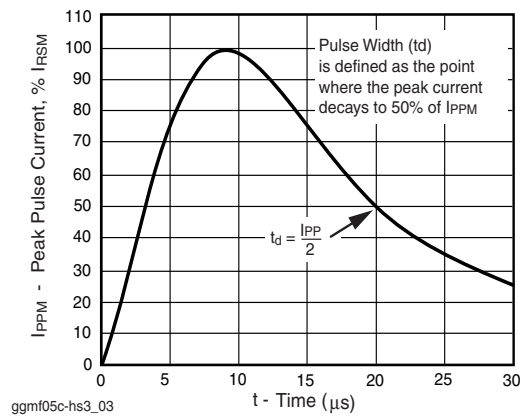

Figure 3. Pulse Waveform

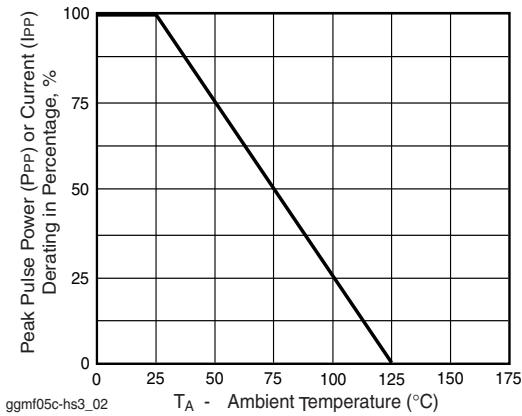

Figure 2. Pulse Derating Curve

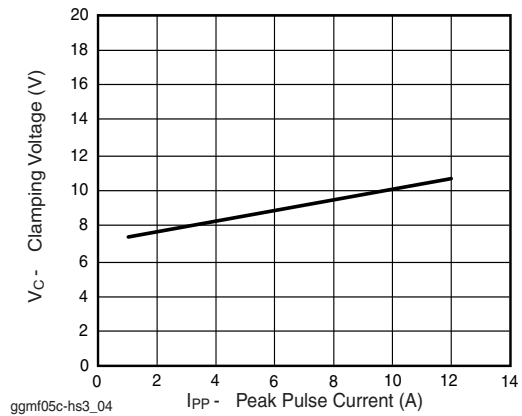
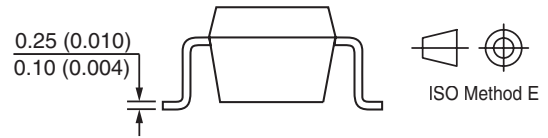
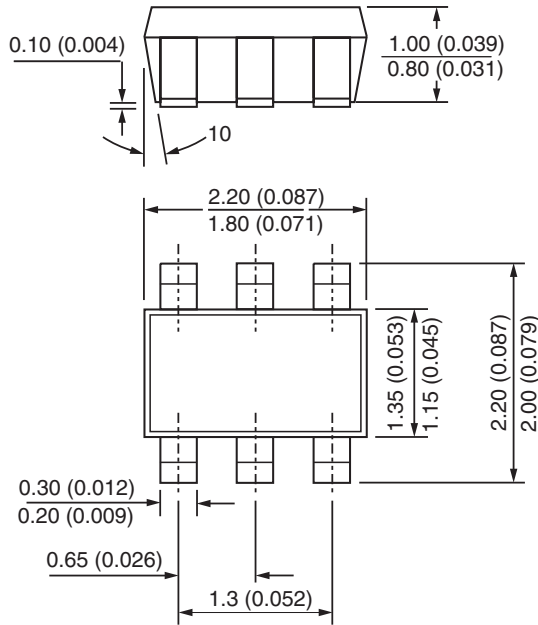
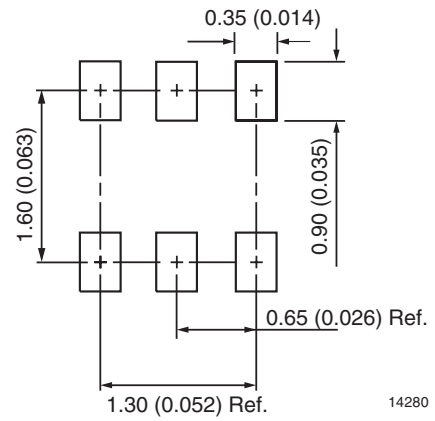

Figure 4. Clamping Voltage vs. Peak Pulse Current

Package Dimensions in mm (Inches)



Mounting Pad Layout



14280

Ozone Depleting Substances Policy Statement

It is the policy of Vishay Semiconductor GmbH to

1. Meet all present and future national and international statutory requirements.
2. Regularly and continuously improve the performance of our products, processes, distribution and operating systems with respect to their impact on the health and safety of our employees and the public, as well as their impact on the environment.

It is particular concern to control or eliminate releases of those substances into the atmosphere which are known as ozone depleting substances (ODSs).

The Montreal Protocol (1987) and its London Amendments (1990) intend to severely restrict the use of ODSs and forbid their use within the next ten years. Various national and international initiatives are pressing for an earlier ban on these substances.

Vishay Semiconductor GmbH has been able to use its policy of continuous improvements to eliminate the use of ODSs listed in the following documents.

1. Annex A, B and list of transitional substances of the Montreal Protocol and the London Amendments respectively
2. Class I and II ozone depleting substances in the Clean Air Act Amendments of 1990 by the Environmental Protection Agency (EPA) in the USA
3. Council Decision 88/540/EEC and 91/690/EEC Annex A, B and C (transitional substances) respectively.

Vishay Semiconductor GmbH can certify that our semiconductors are not manufactured with ozone depleting substances and do not contain such substances.

We reserve the right to make changes to improve technical design
and may do so without further notice.

Parameters can vary in different applications. All operating parameters must be validated for each customer application by the customer. Should the buyer use Vishay Semiconductors products for any unintended or unauthorized application, the buyer shall indemnify Vishay Semiconductors against all claims, costs, damages, and expenses, arising out of, directly or indirectly, any claim of personal damage, injury or death associated with such unintended or unauthorized use.

Vishay Semiconductor GmbH, P.O.B. 3535, D-74025 Heilbronn, Germany
Telephone: 49 (0)7131 67 2831, Fax number: 49 (0)7131 67 2423