

### Description

Dual center tap Schottky rectifier designed for high frequency Switched Mode Power Supplies.

### Features

- High junction temperature capability
- Good trade off between leakage current and forward voltage drop
- Low leakage current

### Applications

- |  |  |
|--|--|
| <ul style="list-style-type: none"> <li>■ Switching Power Supply</li> <li>■ Industrial Application</li> <li>■ Computer and Peripheral</li> <li>■ Home Appliance</li> <li>■ Consumer Product</li> <li>■ Battery Charger/Adapter</li> </ul> | <ul style="list-style-type: none"> <li>■ LCD Monitor/TV</li> <li>■ AC-DC Converter</li> <li>■ DC-DC Converter</li> <li>■ Telecommunication</li> <li>■ Free Wheeling Diodes</li> <li>■ Polarity Protection</li> </ul> |
|--|--|

### Marking Information and Pin Configurations (Top View)

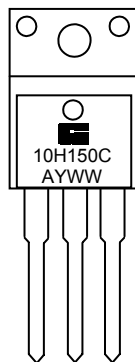

TO - 220FPAB & TO - 220AB

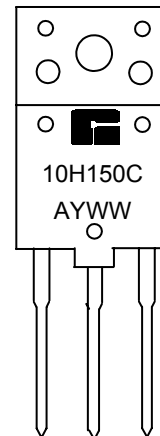

TO - 3PF

10: Maximum average forward rectified current - 10A  
 H: Low  $V_F$  family  
 150: Repetitive peak reverse voltage - 150V  
 C: Dual Cathode Common  
 A: Assembly Location  
 Y: Year  
 WW: Work Week

### Ordering Information

ORDERING NUMBER	PACKAGE	SHIPPING
GMR10H150CTA3T	TO263	50 Units/ Tube
GMR10H150CTA3R	TO263	800 Units/ Tape & Reel
GMR10H150CTB3T	TO220AB	50 Units/ Tube
GMR10H150CTBF3T	TO220FPAB	50 Units/ Tube
GMR10H150CTPF3	TO-3PF	30 Units/ Tube

### Block Diagram

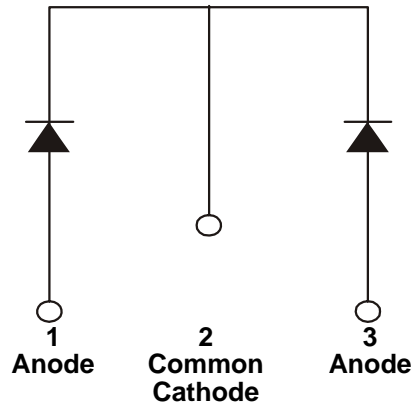

## Absolute Maximum Ratings

PARAMETER	SYMBOL	VALUE	UNITS
Repetitive Peak Reverse Voltage	$V_{RPM}$	150	V
RMS Forward Current	$I_{F(RMS)}$	10	A
Peak Forward Surge Current 8.3ms single half sine-wave superimposed on rated load (JEDEC METHOD)	$I_{FSM}$	110	A
Maximum Operating Junction Temperature	$T_J$	175	°C
Operating storage temperature	$T_{STG}$	-45 to +150	°C
Voltage Rate of Change	dV/dt	10,000	V/μs
Electrostatic Discharge Voltage. JEDEC Method. ESD HBM. Contact	VESD	± 8	kV

## Thermal Characteristics

PARAMETER	SYMBOL	TO220AB	TO220FPAB	TO263	TO-3PF	UNITS
Typical thermal resistance	$\Theta_{JC}$	2.4	4.2	2.4	1.2	°C/W

## Electrical Characteristics (per diode) $T_J = 25^\circ\text{C}$ , Unless otherwise noted

PARAMETER	SYMBOL	Test Condition	Min	Typ	Max	Units
DC Forward Voltage	$V_F$	$I_F = 5\text{A}$		0.85	0.87	V
Average Rectified Forward Current	$I_{F(AV)}$				5.0	A
Maximum Reverse Current	$I_R$	$V_R = 150\text{V}$	-	-	5	μA
		$V_R = 150\text{V}, T_J = 125^\circ\text{C}$		-	5	mA

### Package Outline Dimensions – TO263

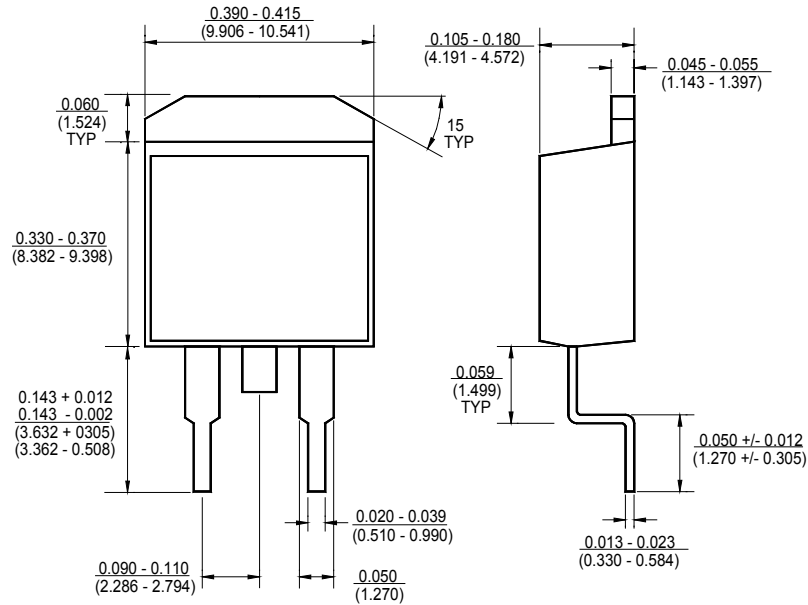

### Package Outline Dimensions – TO220AB

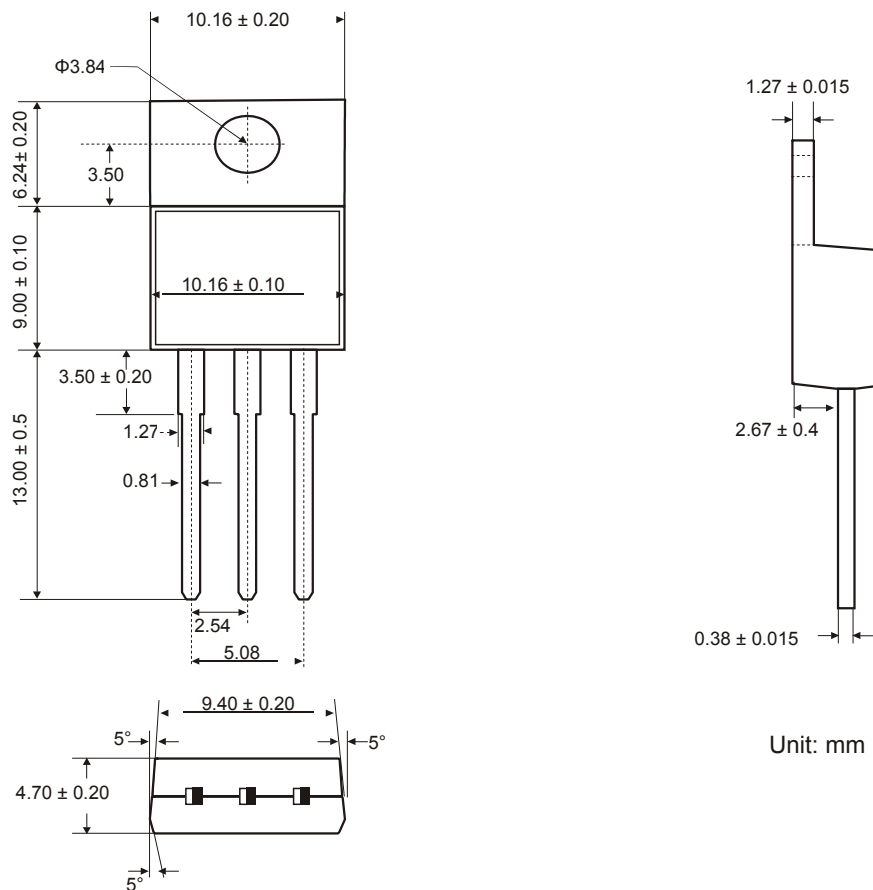

Unit: mm

## Package Outline Dimensions – TO220FPAB

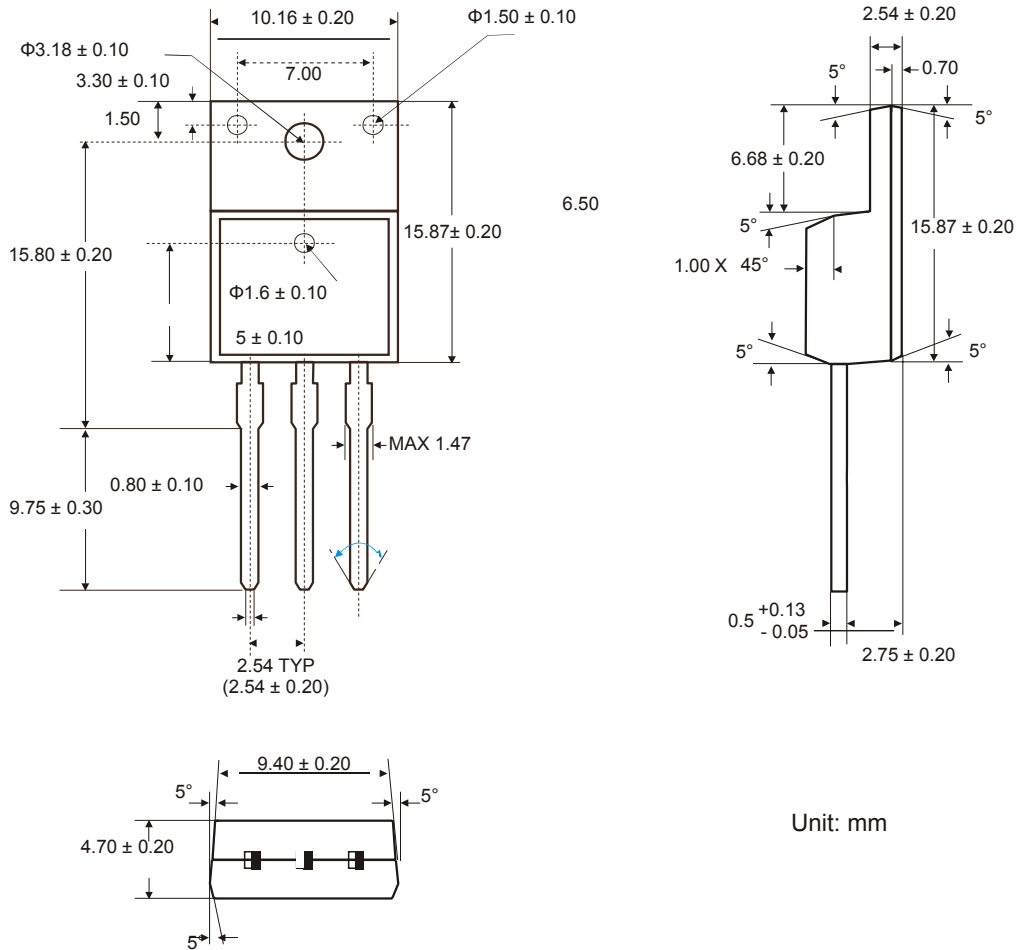

### Package Outline Dimensions – TO-3PF

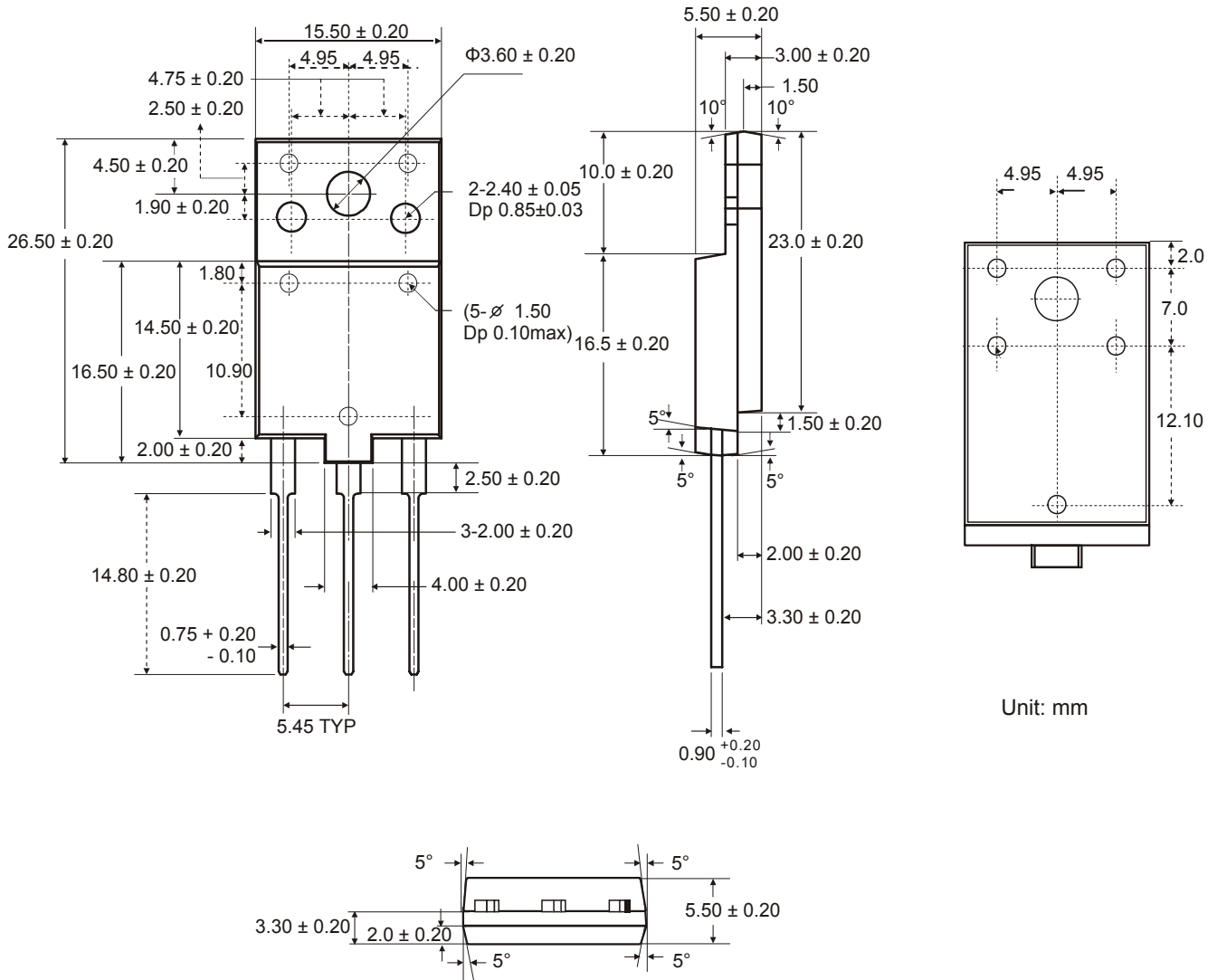

### Ordering Number

**GM R 10 H 150 C TA3 I**

APM  
Gamma  
Micro

Circuit  
Type:  
Rectifier

Rated  
Current  
10A

Low  $V_F$   
Family

Rated  
Voltage  
150V

Dual  
Cathode  
Common

Package

TA3: TO263  
TB3: TO220AB  
TBF3: TO220FPAB  
TPF3: TO-3PF

Shipping

T: Tube  
R: Tape & Reel