

GP1A50HR/GP1A51HR GP1A52HR/GP1A53HR

OPIC Photointerrupter

■ Features

1. High sensing accuracy (Slit width : 0.5mm)
2. LSTTL and TTL compatible output
3. Both-sides mounting type : **GP1A50HR** (Gap: 3mm)
 Either-side mounting type : **GP1A51HR** (Gap: 3mm)
 PWB mounting type : **GP1A52HR** (Gap: 3mm)
GP1A53HR (Gap: 5mm)

■ Applications

1. OA equipment, such as printers, facsimiles, etc.
2. VCRs

OPIC (Optical IC) is a trademark of the SHARP Corporation.
 An OPIC consists of a light-detecting element and signal-processing circuit integrated onto a single chip.

■ Outline Dimensions

(Unit : mm)

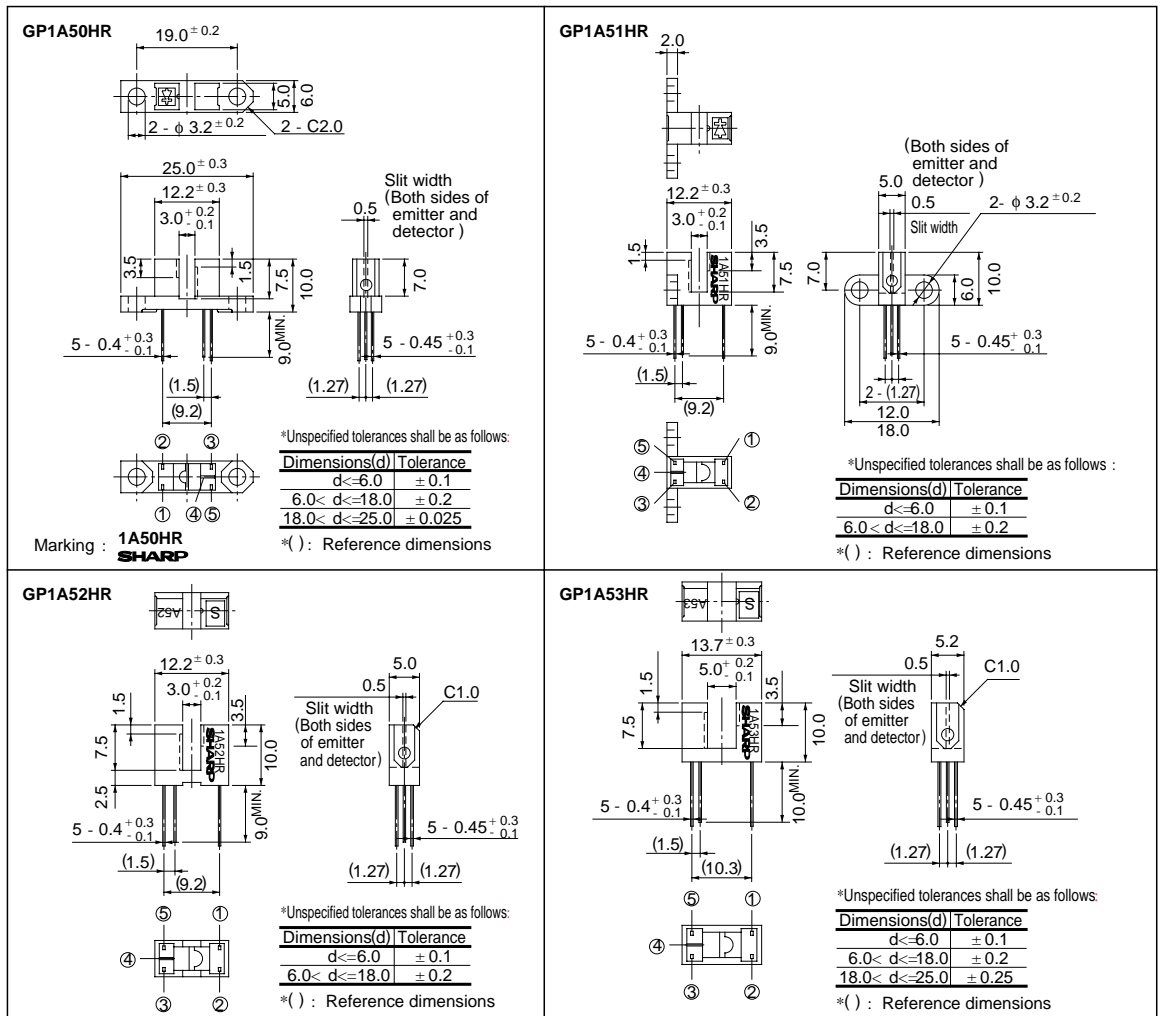

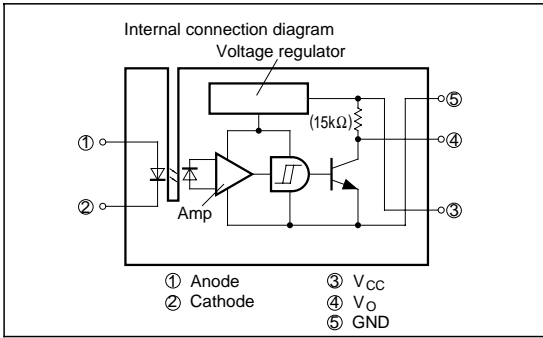

Absolute Maximum Ratings

(T_a = 25°C)

| | Parameter | Symbol | Rating | Unit |
|--------------------------|-------------------------|------------------|---------------|------|
| Input | Forward current | I _F | 50 | mA |
| | *1 Peak forward current | I _{FM} | 1 | A |
| | Reverse voltage | V _R | 6 | V |
| | Power dissipation | P | 75 | mW |
| Output | Supply voltage | V _{CC} | - 0.5 to + 17 | V |
| | Output current | I _O | 50 | mA |
| | Power dissipation | P _O | 250 | mW |
| Operating temperature | | T _{opr} | - 25 to + 85 | °C |
| Storage temperature | | T _{stg} | - 40 to + 100 | °C |
| *2 Soldering temperature | | T _{sol} | 260 | °C |

*1 Pulse width ≤ 100 μs, Duty ratio = 0.01

*2 For 5 seconds

Electro-optical Characteristics

(T_a = 25°C)

| Parameter | | Symbol | Conditions | MIN. | TYP. | MAX. | Unit | |
|--------------------------|---------------------------------------|-----------------------------------|--|--|------|------|------|----|
| Input | Forward voltage | GP1A50HR/GP1A51HR GP1A52HR | V _F I _F = 5mA | - | 1.1 | 1.4 | V | |
| | | GP1A53HR | V _F I _F = 8mA | - | 1.14 | 1.4 | V | |
| | Reverse current | I _R | V _R = 3V | - | - | 10.0 | μA | |
| Operating supply voltage | | V _{CC} | | 4.5 | - | 17.0 | V | |
| Output | Low level output voltage | V _{OL} | V _{CC} = 5V, I _F = 0, I _{OL} = 16mA | - | 0.15 | 0.4 | V | |
| | High level output voltage | V _{OH} | V _{CC} = 5V, *5 I _F = 5mA | 4.9 | - | - | V | |
| | Low level supply current | I _{CCL} | V _{CC} = 5V, I _F = 0 | - | 1.7 | 3.8 | mA | |
| | High level supply current | I _{CCH} | V _{CC} = 5V, *5 I _F = 5mA | - | 0.7 | 2.2 | mA | |
| Transfer characteristics | *3 "Low→High" threshold input current | GP1A50HR/GP1A51HR GP1A52HR | I _{FLH} V _{CC} = 5V | - | 1.0 | 5.0 | mA | |
| | | GP1A53HR | I _{FLH} V _{CC} = 5V | - | 1.5 | 8.0 | mA | |
| | *4 Hysteresis | | I _{FHL} / I _{FLH} | V _{CC} = 5V | 0.55 | 0.75 | 0.95 | |
| | Response time | "Low→High" propagation delay time | t _{PLH} | V _{CC} = 5V, *5 I _F = 5mA R _L = 280Ω | - | 3.0 | 9.0 | μs |
| | | "High→Low" propagation delay time | t _{PHL} | | - | 5.0 | 15.0 | |
| | | Rise time | t _r | | - | 0.1 | 0.5 | |
| Fall time | | t _f | - | | 0.05 | 0.5 | | |

*3 I_{FLH} represents forward current when output changes from low to high.*4 I_{FHL} represents forward current when output changes from high to low. Hysteresis stands for I_{FHL} / I_{FLH}.*5 GP1A53HR Condition of V_{OH}, I_{CCH}, Response time; I_F = 8mA

■ Recommended Operating Conditions

| Parameter | Symbol | Operating temp. | MIN. | MAX. | Unit |
|--------------------------|----------|---|------|------|------|
| Low level output current | I_{OL} | $T_a = 0 \text{ to } +70^\circ\text{C}$ | - | 16.0 | mA |
| Forward current | I_F | | 10.0 | 20.0 | mA |

Fig. 1 Forward Current vs. Ambient Temperature

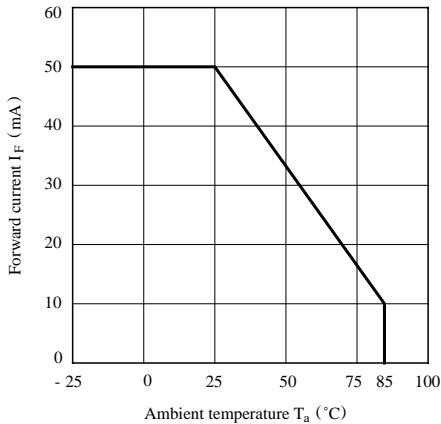

Fig. 2 Output Power Dissipation vs. Ambient Temperature

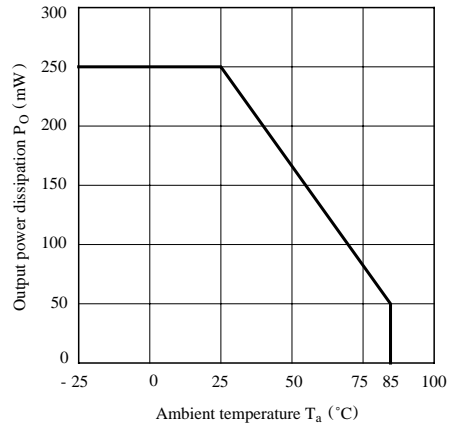

Fig. 3 Low Level Output Current vs. Ambient Temperature

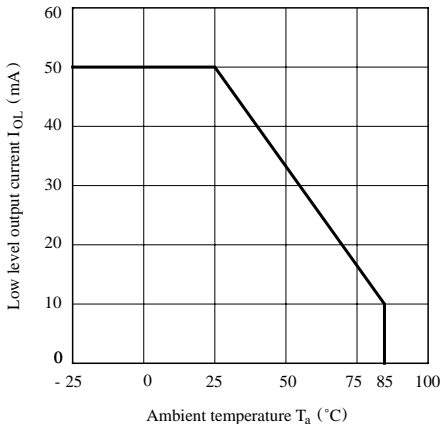

Fig. 4 Forward Current vs. Forward Voltage

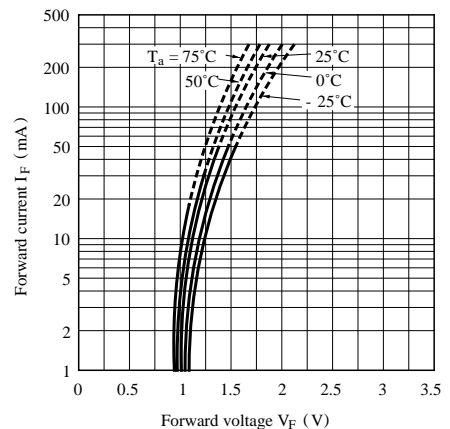

Fig. 5 Relative Threshold Input Current vs. Supply Voltage

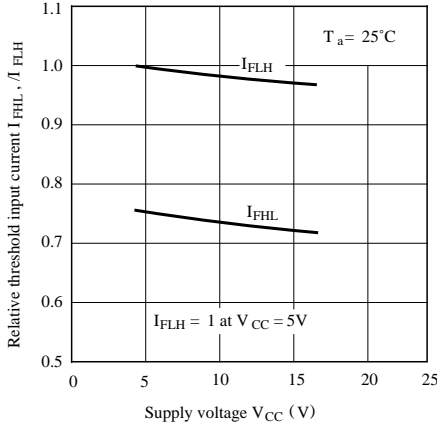

Fig. 6 Relative Threshold Input Current vs. Ambient Temperature

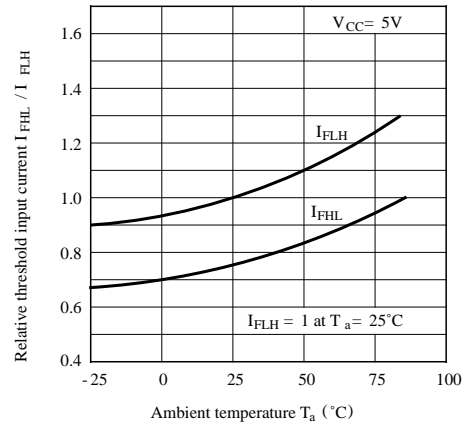

Fig. 7 Low Level Output Voltage vs. Low Level Output Current

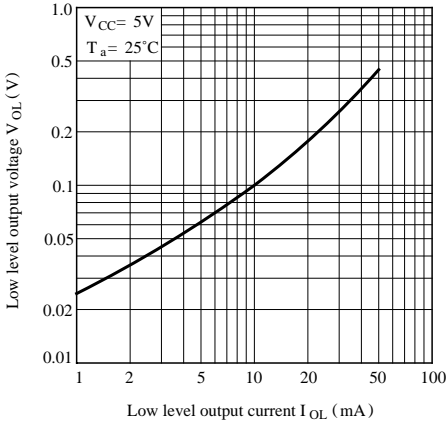

Fig. 8 Low Level Output Voltage vs. Ambient Temperature

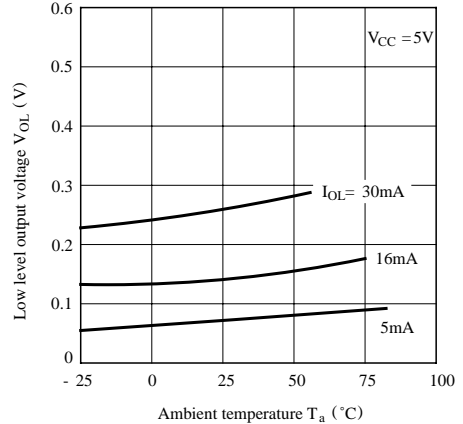

Fig. 9 Supply Current vs. Ambient Temperature

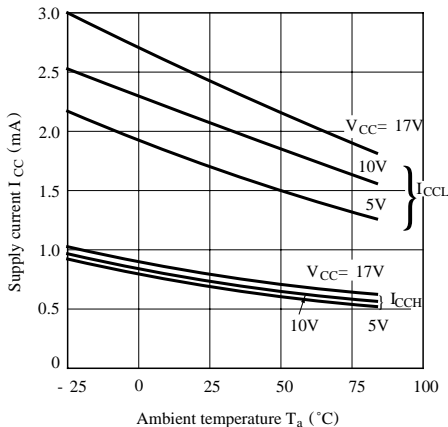

Fig.10-a Propagation Delay Time vs. Forward Current (GP1A50HR/GP1A51HR/GP1A52HR)

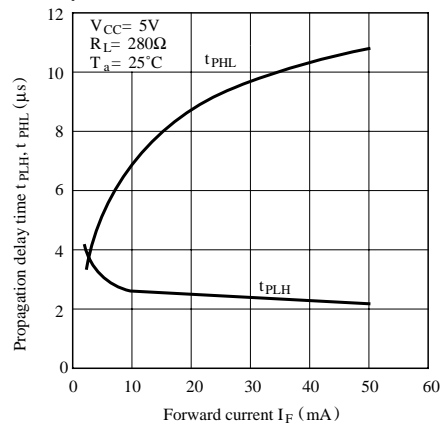

Fig.10-b Propagation Delay Time vs. Forward Current (GP1A53HR)

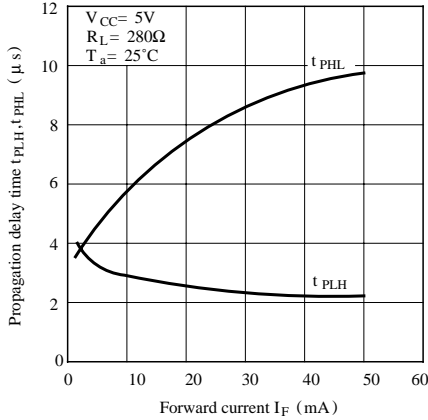
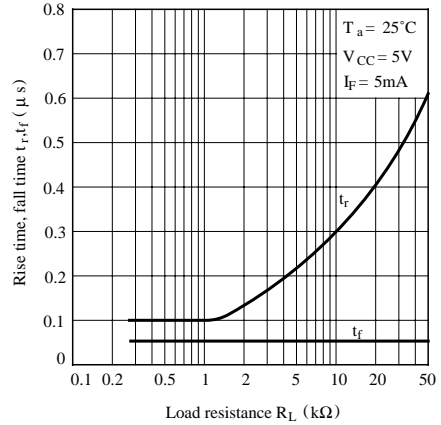
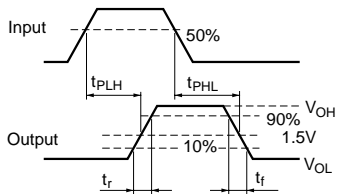
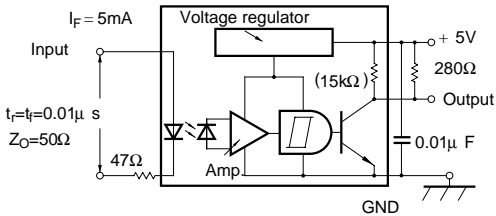

Fig.12 Rise Time, Fall Time vs. Load Resistance



Test Circuit for Response Time



■ Precautions for Use

- (1) In order to stabilize power supply line, connect a by-pass capacitor of more than $0.01\mu F$ between V_{CC} and GND near the device.
- (2) In case of cleaning, use only the following type of cleaning solvent.
Ethyl alcohol, Methyl alcohol, Isopropyl alcohol
- (3) As for other general cautions refer to the chapter "Precautions for Use".