

GP2S30

Long Focal Distance Type Photointerrupter with Connector

■ Features

1. Long focal distance
Detection distance: 3 to 7mm
2. High sensing accuracy by laser
trimming of resistor
3. 3-pin connector

■ Applications

1. Printers
2. Facsimiles
3. Copiers

■ Outline Dimensions

(Unit : mm)

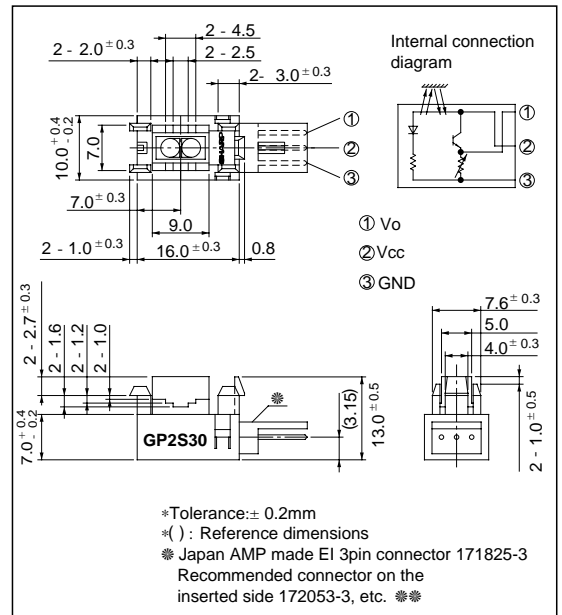

* * * Recommended connectors on the inserted side are shown on the below page.

■ Absolute Maximum Ratings (Ta = 25°C)

Parameter	Symbol	Rating	Unit
Supply voltage	V _{CC}	- 0.5 to + 7	V
Output current	I _O	I	mA
^{#1} Operating temperature	T _{opr}	- 20 to + 70	°C
^{#1} Storage temperature	T _{stg}	- 40 to + 80	°C

*1 The connector should be plugged in/out and the unit's hook should be used at normal temperature.

■ Electro-optical Characteristics

(V_{CC} = 5V, Ta = 25°C unless otherwise specified)

Parameter	Symbol	Conditions	MIN.	TYP.	MAX.	Unit
Operating supply voltage	V _{CC}	Ta = - 20 to + 70°C	4.5	5.0	5.5	V
Dissipation current	I _{CC}	^{#2} At detecting, d = 5mm	-	26	35	mA
Low level output voltage	V _{OL}	^{#3} At non-detecting, d = 5mm	-	0.2	0.8	V
High level output voltage	V _{OH}	^{#2} At detecting, d = 5mm	2.1	3.0	3.9	V
Response frequency	f	*4	-	-	170	Hz

*2 At detecting : White PPC paper as a reflective object without external disturbing light in Fig. 1.

*3 At non-detecting : Black suede tape as a reflective object without external disturbing light in Fig. 1.

*4 The definition of response frequency is shown in Fig. 2.

Fig. 1 Test Condition for V_o

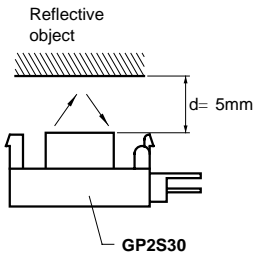
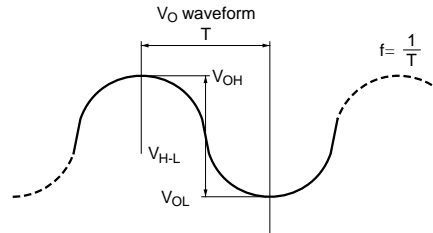
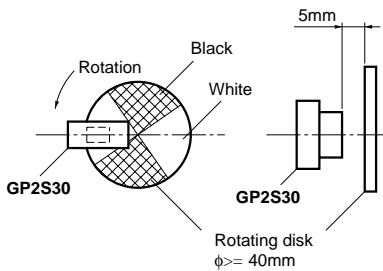

Fig. 2 Definition of Response Frequency



Response frequency: Rotational frequency f when V_{H-L} decreases 3dB from DC.

Fig. 3 Relative Output Voltage vs. Ambient Temperature

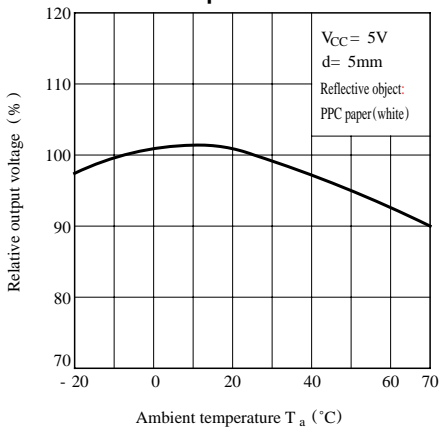

Fig. 4 Dissipation Current vs. Supply Voltage

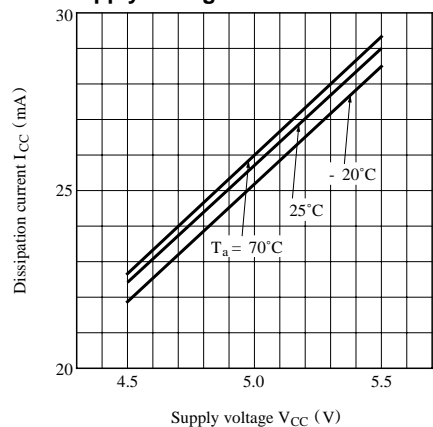

Fig. 5 Relative Output Voltage vs. Detecting Distance

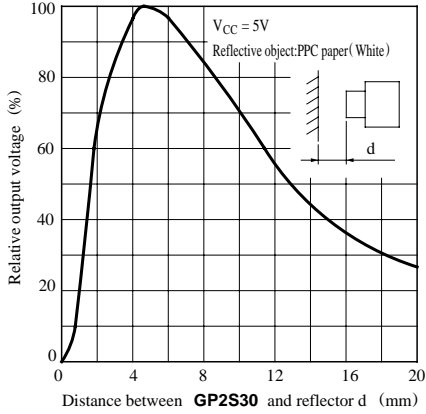

Fig. 6 Relative Collector Voltage vs. Reflector Moving Distance (1)

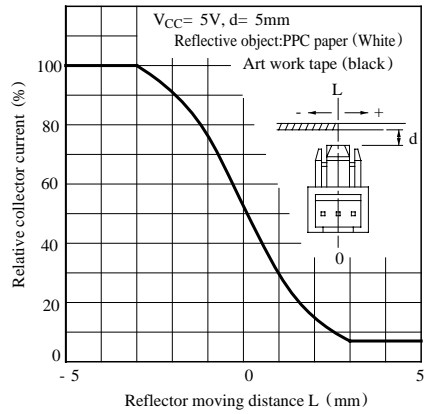
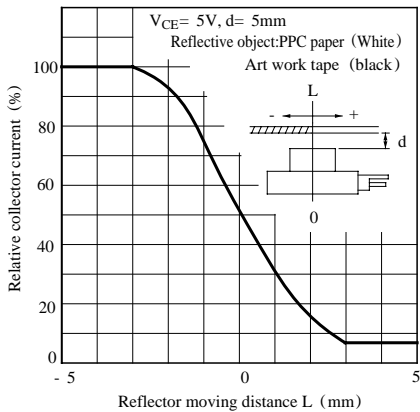
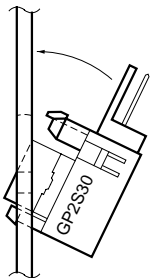

Fig. 7 Relative Collector Voltage vs. Reflector Moving Distance (2)



Recommended Mounting Holes (mm)



Board thickness $1.6^{+0.17}_{-0.12}$ mm

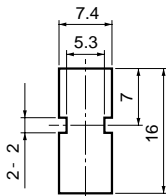

Board thickness $1.2^{+0.17}_{-0.12}$ mm

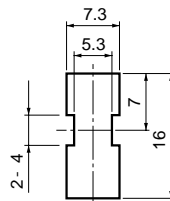

Board thickness $1.0^{+0.17}_{-0.12}$ mm

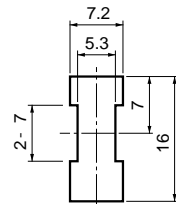

Mounting Method

Recommended Mounting Holes

■ Recommended Connectors on the Inserted Side

● JAPAN AMP made EI series connector (standard type)

Housing color	Natural color	Black	Blue	Green	Red
Housing Model No.	171822-3	2-171822-3	4-171822-3	6-171822-3	8-171822-3
Special terminal Model No.	AWG size	Product shape	Material	Model No.	
	AWG 26 to 20	Chain	Brass	170204-1	
			phosphor bronze	170204-2	
		Bulk	Brass	170262-1	
			phosphor bronze	170262-2	
	AWG 30 to 26	Chain	Brass	170205-1	
			phosphor bronze	170205-2	
		Bulk	Brass	170263-1	
phosphor bronze			170263-2		

● JAPAN AMP made EI Series connectors (low profile type)

Housing color	Natural color	Black	Blue	Green	Red
Housing Model No.	172142-3	2-172142-3	4-172142-3	6-172142-3	8-172142-3
Special terminal Model No. (Material: phosphor bronze)	AWG size	Product shape	Model No.		
	AWG 26 to 22	Bulk	170369-1		
		Chain	170354-1		
	AWG 30 to 26	Bulk	170370-1		
Chain		170355-1			

● JAPAN AMP made EI Series connectors (amp. mass termination)

Housing terminal united type connector	AWG28 (Green)	AWG26 (Natural color)	AWG24 (Black)	AWG22 (Red)
	172054-3	172053-3	172052-3	172051-3

* Terminal Material: phosphor bronze

■ Recommended Circuit

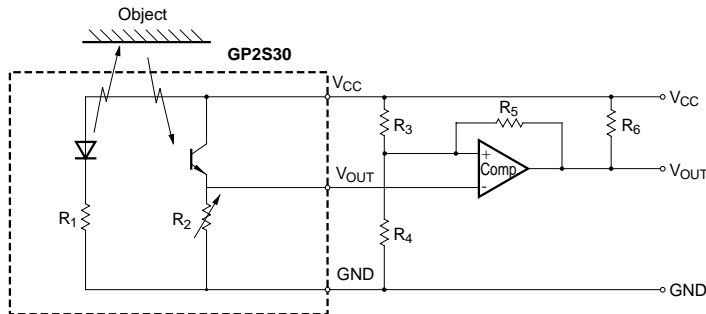

■ Precautions for Use

- (1) In this product, the PWB is fixed with a hook, and cleaning solvent may remain inside the case; therefore, dip cleaning or ultrasonic are prohibited.
- (2) Remove dust or stains, using an air blower or a soft cloth moistened in cleaning solvent. However, do not perform the above cleaning using a soft cloth with cleaning solvent in the marking portion.

In this case, use only the following type of cleaning solvent used for wiping off:

Ethyl alcohol, Methyl alcohol, Isopropyl alcohol,

When the cleaning solvents except for specified materials are used, please consult us.

- (3) As for other general cautions, refer to the chapter "Precautions for Use".