

GP2S40

Long Focal Distance, Subminiature Photointerrupter

■ Features

1. Ultra compact DIP package
(Volume: 1/3 of **GP2S05**)
2. Long focal distance type
(focal distance: 3mm)
3. Effective detection distance: 1.5 to 6.5mm

■ Applications

1. Copiers
2. Facsimiles
3. Printers

■ Outline Dimensions

(Unit : mm)

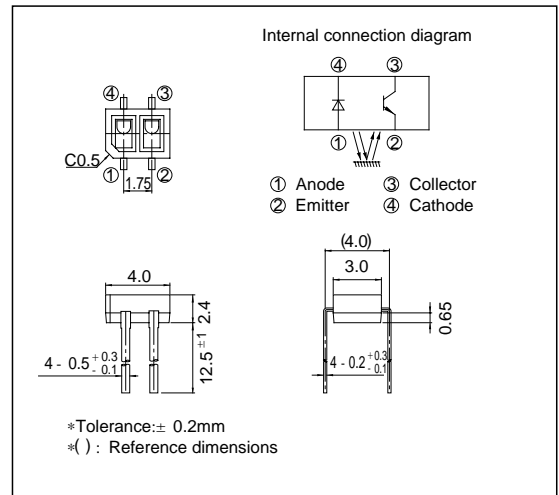

■ Absolute Maximum Ratings

(Ta = 25°C)

Parameter		Symbol	Rating	Unit
Input	Forward current	I _F	50	mA
	Reverse voltage	V _R	6	V
	Power dissipation	P _D	75	mW
Output	Collector-emitter voltage	V _{CEO}	35	V
	Emitter-collector voltage	V _{ECO}	6	V
	Collector current	I _C	20	mA
	Collector power dissipation	P _C	75	mW
Total power dissipation		P _{tot}	100	mW
Operating temperature		T _{opr}	- 25 to + 85	°C
Storage temperature		T _{sg}	- 40 to + 100	°C
*1 Soldering temperature		T _{sol}	260	°C

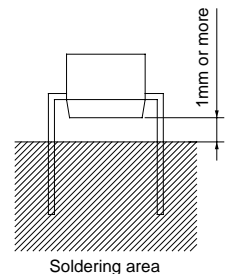

*1 For 5 seconds

Electro-optical Characteristics

($T_a = 25^\circ\text{C}$)

Parameter		Symbol	Condition	MIN.	TYP.	MAX.	Unit	
Input	Forward voltage	V_F	$I_F = 20\text{mA}$	-	1.2	1.4	V	
	Reverse current	I_R	$V_R = 3\text{V}$	-	-	10	μA	
Output	Collector dark current	I_{CEO}	$V_{CE} = 20\text{V}$	-	1	100	nA	
Transfer characteristics	Collector current	I_C	$V_{CE} = 5\text{V}, I_F = 20\text{mA}$	0.5	-	3.0	mA	
	*2Leak current		I_{LEAK}	$V_{CE} = 5\text{V}, I_F = 20\text{mA}$	-	-	500	nA
	*3Response time	Rise time	t_r	$V_{CE} = 2\text{V}, I_C = 100\mu\text{A}$	-	50	150	μs
		Fall time	t_f	$R_L = 1\,000\Omega, d = 4\text{mm}$	-	50	150	μs

*2 No reflective object

*3 "d" is glass thickness of reflective mirror.

Test Arrangement of Collector Current

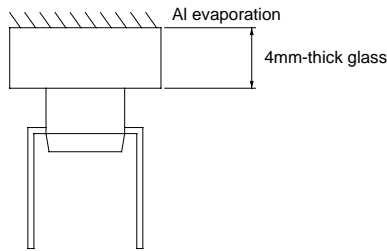

Fig. 1 Forward Current vs. Ambient Temperature

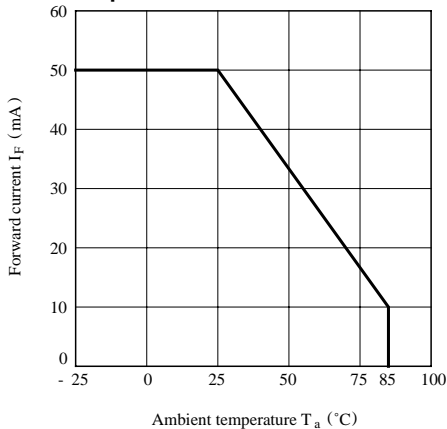

Fig. 2 Power Dissipation vs. Ambient Temperature

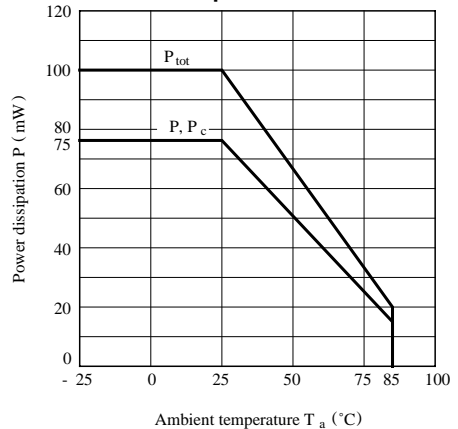

Fig. 3 Forward Current vs. Forward Voltage

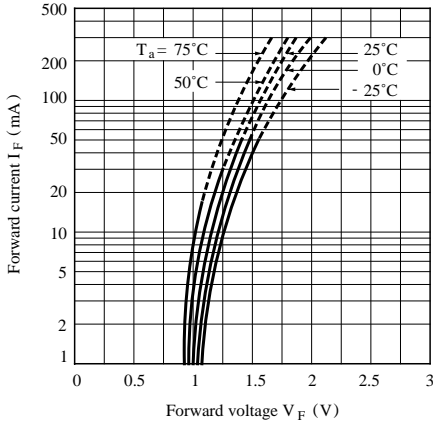

Fig. 4 Collector Current vs. Forward Current

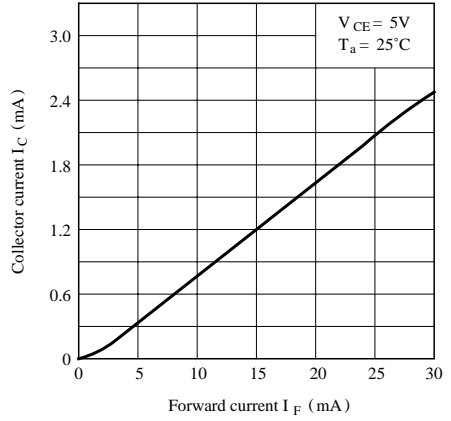

Fig. 5 Collector Current vs. Collector-emitter Voltage

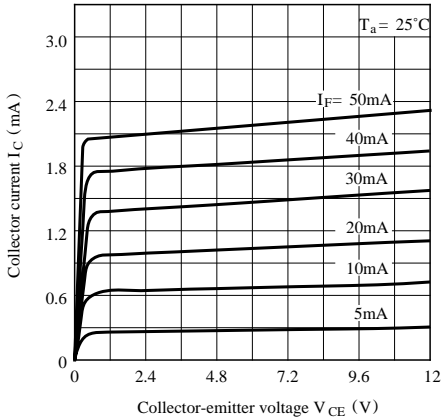

Fig. 6 Relative Collector Current vs. Ambient Temperature

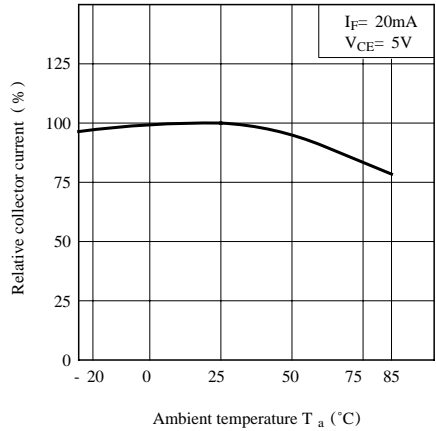

Fig. 7 Collector Dark Current vs. Ambient Temperature

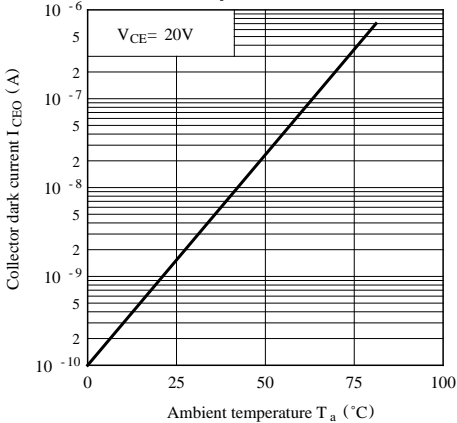
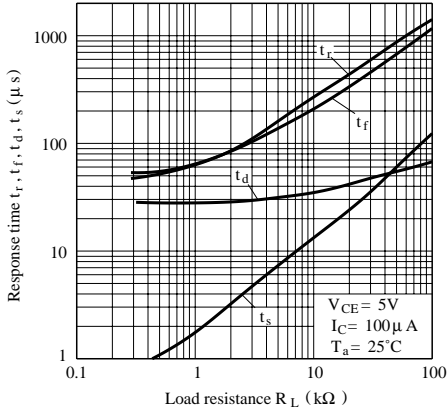

Fig. 8 Response Time vs. Load Resistance



Test Circuit for Response Time

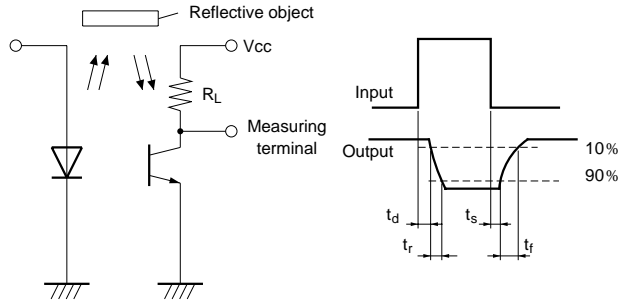

Fig. 9 Relative Collector Current vs. Sensor moving Distance (1)

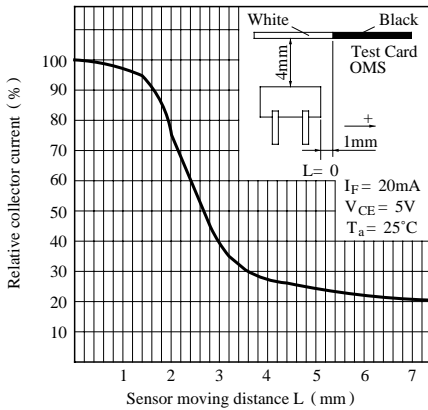

Fig.10 Relative Collector Current vs. Sensor moving Distance (2)

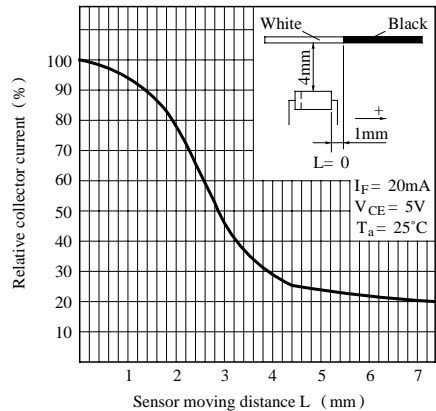

Fig. 11 Relative Collector Current vs. Distance

