

FEATURES

- Non Punch Through Silicon
- Isolated Copper Baseplate with AL_2O_3 Substrate
- Low Inductance Internal Construction

APPLICATIONS

- High Power Inverters
- Motor Controllers
- Induction Heating
- Resonant Converters

The Powerline range of high power modules includes dual, half bridge and single switch configurations covering voltages from 600V to 3300V and currents up to 4800A.

The GP800NSS33 is a single switch 3300V, n channel enhancement mode, insulated gate bipolar transistor (IGBT) module. The IGBT has a wide reverse bias safe operating area (RBSOA) ensuring reliability in demanding applications.

The module incorporates an electrically isolated base plate and low inductance construction enabling circuit designers to optimise circuit layouts and utilise earthed heat sinks for safety.

ORDERING INFORMATION

Order As:

GP800NSS33

Note: When ordering, please use the whole part number.

KEY PARAMETERS

V_{CES}		3300V
$V_{CE(sat)}$	(typ)	3.6V
I_C	(max)	800A
$I_{C(PK)}$	(max)	1600A

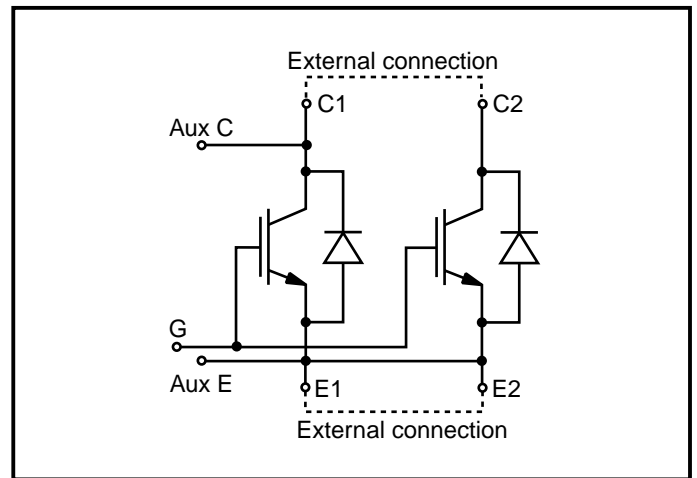

Fig. 1 Single switch circuit diagram

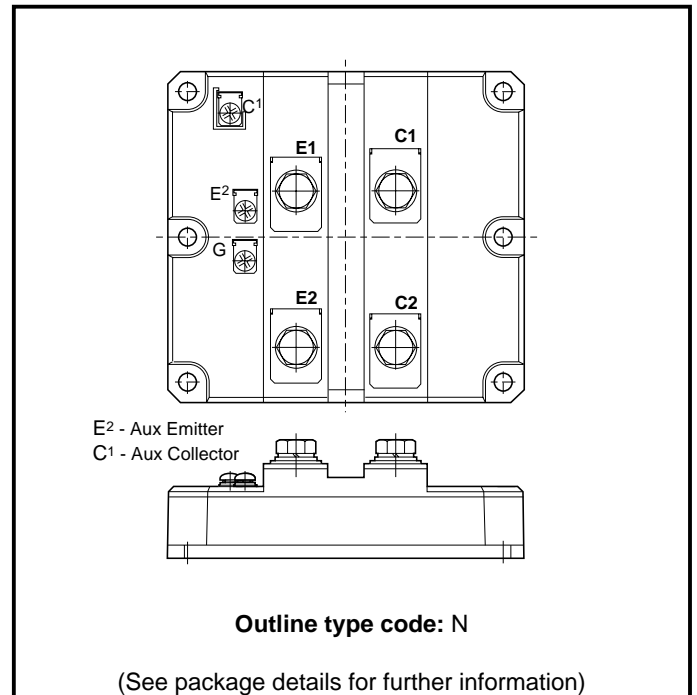

Fig. 2 Electrical connections - (not to scale)

ABSOLUTE MAXIMUM RATINGS

Stresses above those listed under 'Absolute Maximum Ratings' may cause permanent damage to the device. In extreme conditions, as with all semiconductors, this may include potentially hazardous rupture of the package. Appropriate safety precautions should always be followed. Exposure to Absolute Maximum Ratings may affect device reliability.

$T_{case} = 25^{\circ}\text{C}$ unless stated otherwise

Symbol	Parameter	Test Conditions	Max.	Units
V_{CES}	Collector-emitter voltage	$V_{GE} = 0V$	3300	V
V_{GES}	Gate-emitter voltage	-	± 20	V
I_C	Continuous collector current	$T_{case} = 70^{\circ}\text{C}$	800	A
$I_{C(PK)}$	Peak collector current	1ms, $T_{case} = 110^{\circ}\text{C}$	1600	A
P_{max}	Max. transistor power dissipation	$T_{case} = 25^{\circ}\text{C}$, $T_j = 150^{\circ}\text{C}$	8.3	kW
V_{isol}	Isolation voltage	Commoned terminals to base plate. AC RMS, 1 min, 50Hz	6	kV

THERMAL AND MECHANICAL RATINGS

Symbol	Parameter	Test Conditions	Min.	Max.	Units
$R_{th(j-c)}$	Thermal resistance - transistor	Continuous dissipation - junction to case	-	15	$^{\circ}\text{C}/\text{kW}$
$R_{th(j-c)}$	Thermal resistance - diode	Continuous dissipation - junction to case	-	30	$^{\circ}\text{C}/\text{kW}$
$R_{th(c-h)}$	Thermal resistance - case to heatsink (per module)	Mounting torque 5Nm (with mounting grease)	-	8	$^{\circ}\text{C}/\text{kW}$
T_j	Junction temperature	Transistor	-	125	$^{\circ}\text{C}$
		Diode	-	125	$^{\circ}\text{C}$
T_{stg}	Storage temperature range	-	-40	125	$^{\circ}\text{C}$
-	Screw torque	Mounting - M6	-	5	Nm
		Electrical connections - M4	-	2	Nm
		Electrical connections - M8	-	10	Nm

ELECTRICAL CHARACTERISTICS
 $T_{case} = 25^{\circ}\text{C}$ unless stated otherwise.

Symbol	Parameter	Test Conditions	Min.	Typ.	Max.	Units
I_{CES}	Collector cut-off current	$V_{GE} = 0\text{V}, V_{CE} = V_{CES}$	-	-	2	mA
		$V_{GE} = 0\text{V}, V_{CE} = V_{CES}, T_{case} = 125^{\circ}\text{C}$	-	-	70	mA
I_{GES}	Gate leakage current	$V_{GE} = \pm 20\text{V}, V_{CE} = 0\text{V}$	-	-	12	μA
$V_{GE(TH)}$	Gate threshold voltage	$I_C = 120\text{mA}, V_{GE} = V_{CE}$	4	-	7.5	V
$V_{CE(sat)}$	Collector-emitter saturation voltage	$V_{GE} = 15\text{V}, I_C = 800\text{A}$	-	3.6	4.3	V
		$V_{GE} = 15\text{V}, I_C = 800\text{A}, T_{case} = 125^{\circ}\text{C}$	-	4.5	5	V
I_F	Diode forward current	DC	-	-	800	A
I_{FM}	Diode maximum forward current	$t_p = 1\text{ms}$	-	-	1600	A
V_F	Diode forward voltage	$I_F = 800\text{A}$	-	2.3	2.9	V
		$I_F = 800\text{A}, T_{case} = 125^{\circ}\text{C}$	-	2.4	3	V
C_{ies}	Input capacitance	$V_{CE} = 25\text{V}, V_{GE} = 0\text{V}, f = 1\text{MHz}$	-	200	-	nF
L_M	Module inductance	-	-	15	-	nH

ELECTRICAL CHARACTERISTICS

 $T_{\text{case}} = 25^{\circ}\text{C}$ unless stated otherwise

Symbol	Parameter	Test Conditions	Min.	Typ.	Max.	Units
$t_{d(\text{off})}$	Turn-off delay time	$I_C = 800\text{A}$	-	3.2	-	μs
t_f	Fall time	$V_{GE} = \pm 15\text{V}$	-	0.7	-	μs
E_{OFF}	Turn-off energy loss	$V_{CE} = 1800\text{V}$	-	1	-	J
$t_{d(\text{on})}$	Turn-on delay time	$R_{G(\text{ON})} = 3.3\Omega$	-	1.1	-	μs
t_r	Rise time	$R_{G(\text{OFF})} = 6.8\Omega$	-	0.4	-	μs
E_{ON}	Turn-on energy loss	$C_{GE} = 440\text{nF}$, $L \sim 100\text{nH}$	-	1.2	-	J
Q_{rr}	Diode reverse recovery charge	$I_F = 800\text{A}$, $V_R = 1800\text{V}$,	-	750	-	μC
I_{rr}	Diode reverse current	$di_F/dt = 3600\text{A}/\mu\text{s}$	-	400	-	A
E_{REC}	Diode reverse recovery energy		-	0.45	-	J

 $T_{\text{case}} = 125^{\circ}\text{C}$ unless stated otherwise

Symbol	Parameter	Test Conditions	Min.	Typ.	Max.	Units
$t_{d(\text{off})}$	Turn-off delay time	$I_C = 800\text{A}$	-	3.4	-	μs
t_f	Fall time	$V_{GE} = \pm 15\text{V}$	-	1.1	-	μs
E_{OFF}	Turn-off energy loss	$V_{CE} = 1800\text{V}$	-	1.5	-	J
$t_{d(\text{on})}$	Turn-on delay time	$R_{G(\text{ON})} = 3.3\Omega$	-	1.1	-	μs
t_r	Rise time	$R_{G(\text{OFF})} = 6.8\Omega$	-	0.5	-	μs
E_{ON}	Turn-on energy loss	$C_{GE} = 440\text{nF}$, $L \sim 100\text{nH}$	-	1.5	-	J
Q_{rr}	Diode reverse recovery charge	$I_F = 800\text{A}$, $V_R = 1800\text{V}$,	-	800	-	μC
I_{rr}	Diode reverse current	$di_F/dt = 3000\text{A}/\mu\text{s}$	-	650	-	A
E_{REC}	Diode reverse recovery energy		-	0.7	-	J

TYPICAL CHARACTERISTICS

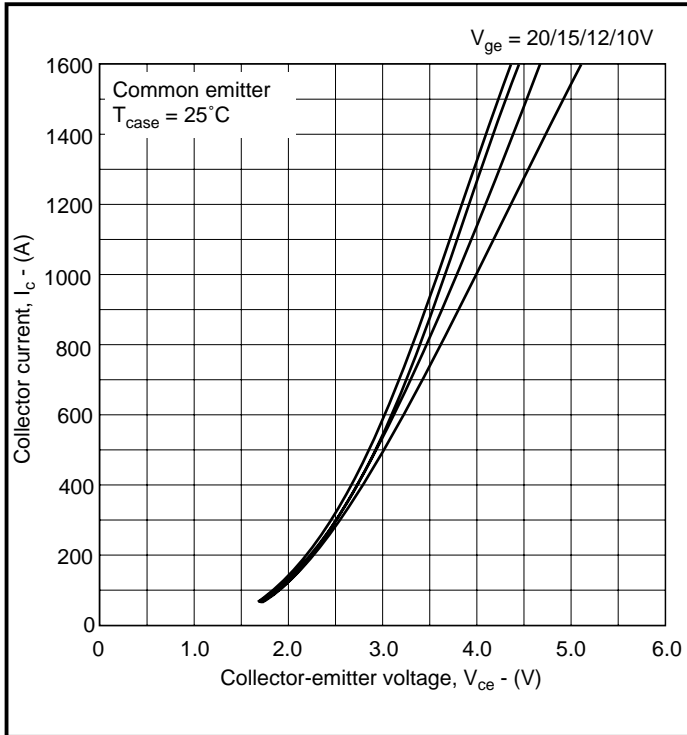

Fig.3 Typical output characteristics

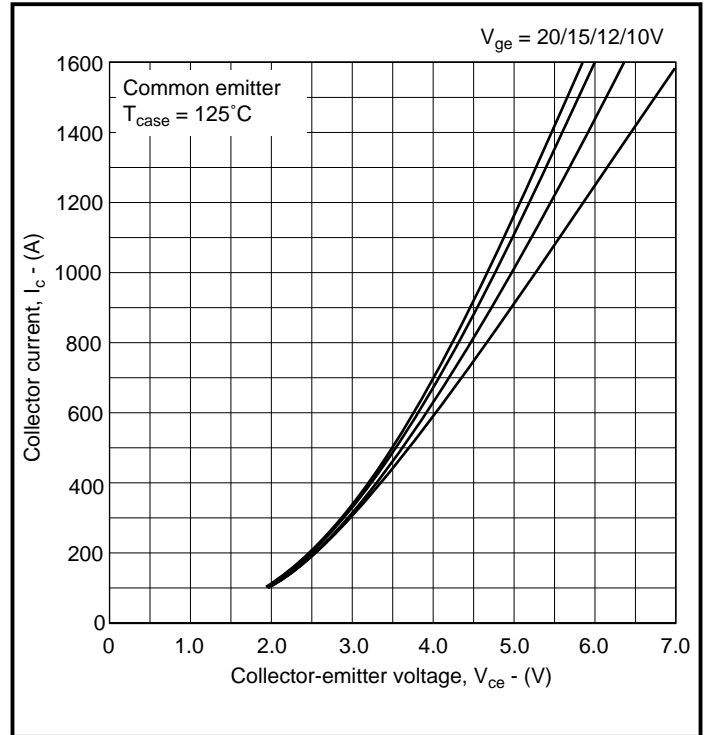

Fig.4 Typical output characteristics

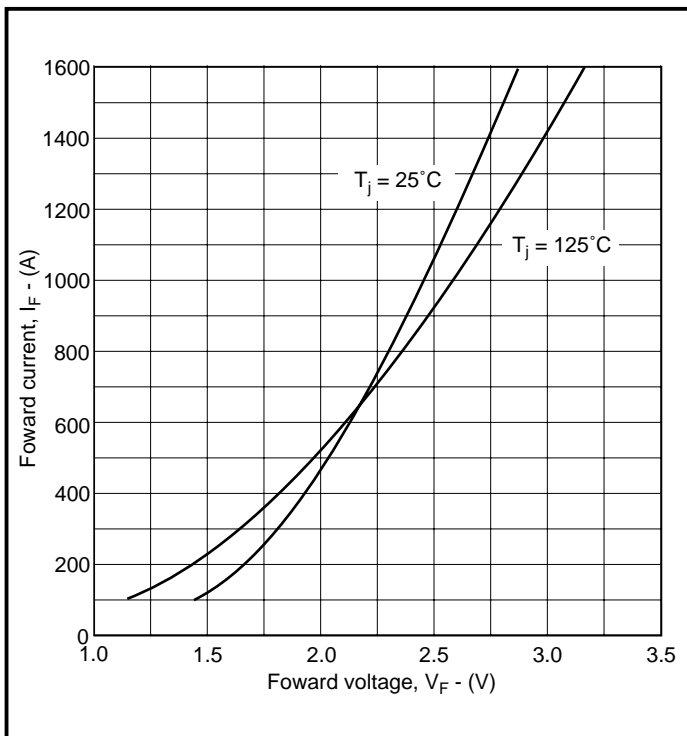

Fig.5 Diode typical forward characteristics

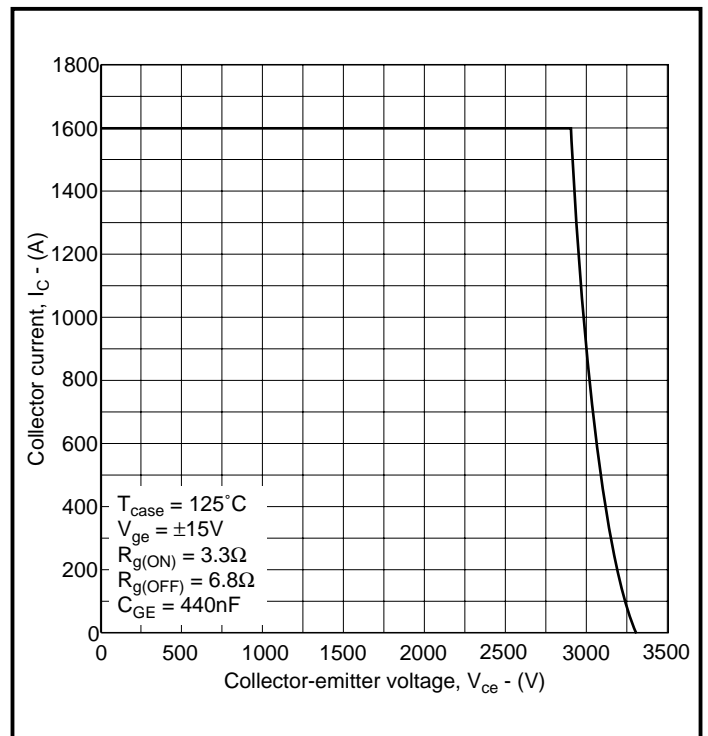

Fig.6 Reverse bias safe operating area

Caution: This device is sensitive to electrostatic discharge. Users should follow ESD handling procedures.

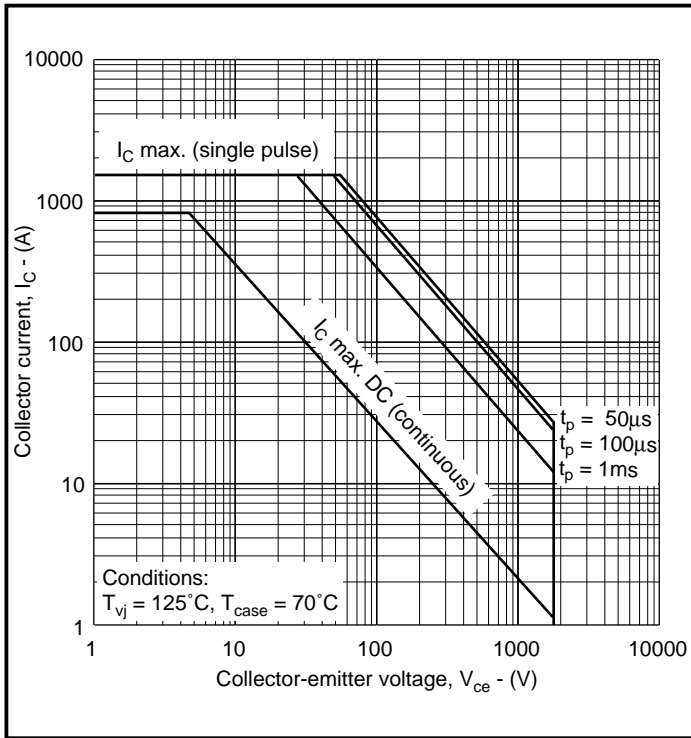

Fig.7 Forward bias safe operating area

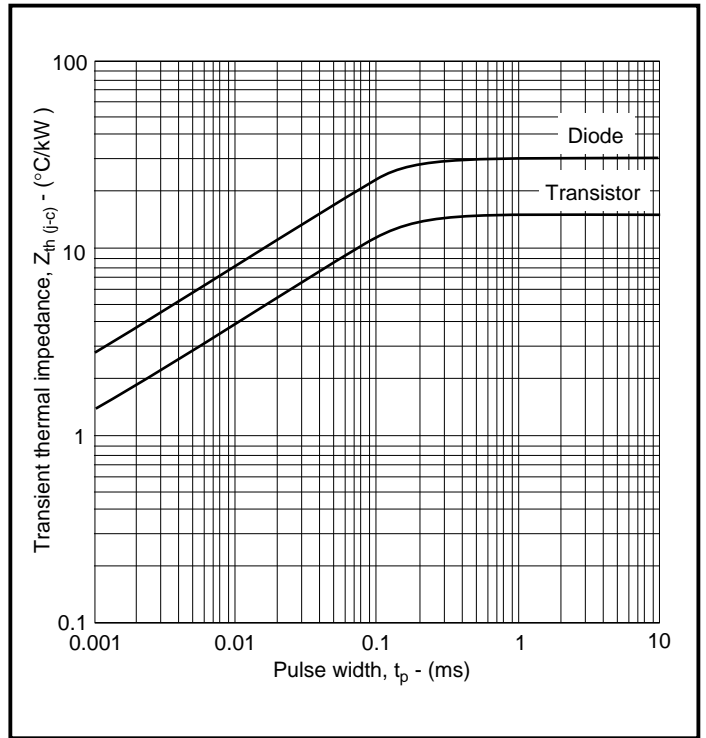

Fig.8 Transient thermal impedance

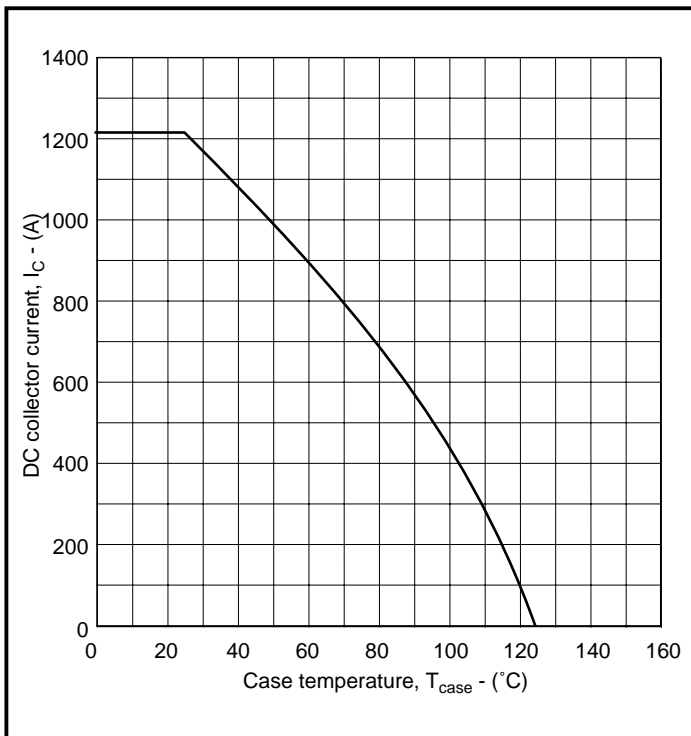

Fig.9 DC current rating vs case temperature

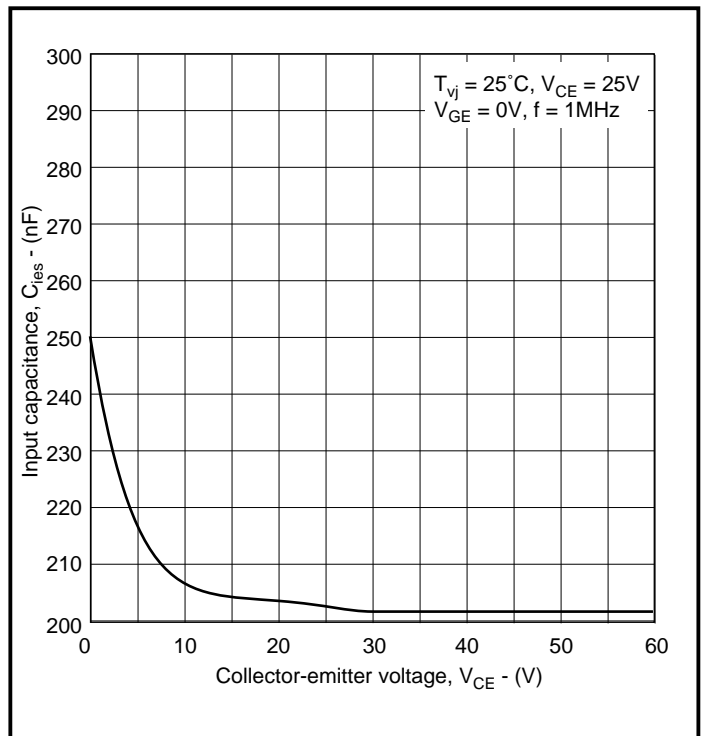
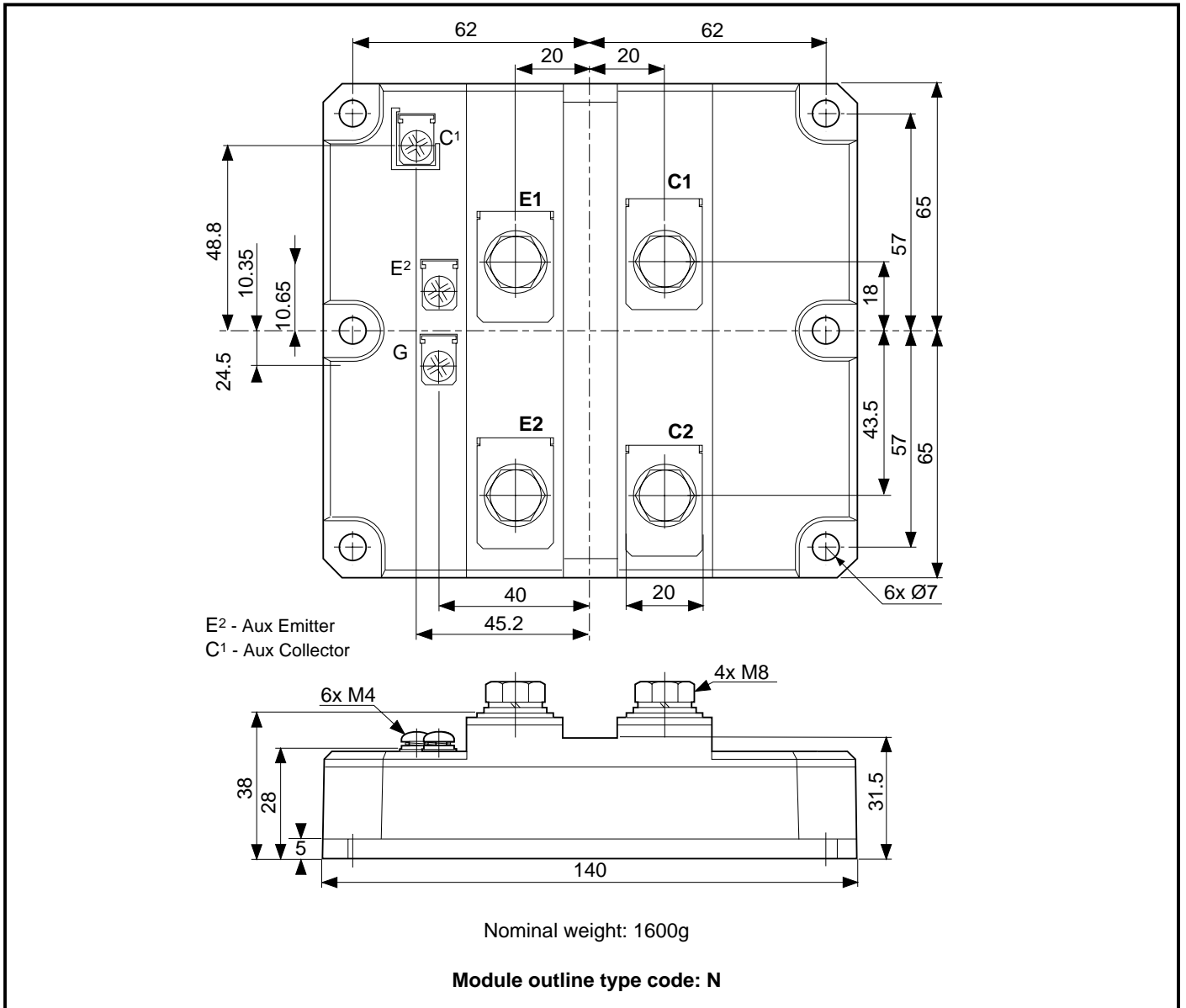

Fig.10 Typical input capacitance

PACKAGE DETAILS

For further package information, please visit our website or contact your nearest Customer Service Centre. All dimensions in mm, unless stated otherwise. DO NOT SCALE.



ASSOCIATED PUBLICATIONS

Title	Application Note Number
Electrostatic handling precautions	AN4502
An introduction to IGBTs	AN4503
IGBT ratings and characteristics	AN4504
Heatsink requirements for IGBT modules	AN4505
Calculating the junction temperature of power semiconductors	AN4506
Gate drive considerations to maximise IGBT efficiency	AN4507
Parallel operation of IGBTs – punch through vs non-punch through characteristics	AN4508
Guidance notes for formulating technical enquiries	AN4869
Principle of rating parallel connected IGBT modules	AN5000
Short circuit withstand capability in IGBTs	AN5167
Driving high power IGBTs with Concept gate drivers	AN5190

POWER ASSEMBLY CAPABILITY

The Power Assembly group provides support for those customers requiring more than the basic semiconductor switch. Using CAD design tools the group has developed a flexible range of heatsink / clamping systems in line with advances in device types and the voltage and current capability of Dynex semiconductors.

An extensive range of air and liquid cooled assemblies is available covering the range of circuit designs in general use today.

HEATSINKS

The Power Assembly group has a proprietary range of extruded aluminium heatsinks. These were designed to optimise the performance of Dynex semiconductors. Data with respect to air natural, forced air and liquid cooling (with flow rates) is available on request.

For further information on device clamps, heatsinks and assemblies, please contact your nearest sales representative or customer service office.



<http://www.dynexsemi.com>

e-mail: power_solutions@dynexsemi.com

HEADQUARTERS OPERATIONS
DYNEX SEMICONDUCTOR LTD
Doddington Road, Lincoln.
Lincolnshire. LN6 3LF. United Kingdom.
Tel: 00-44-(0)1522-500500
Fax: 00-44-(0)1522-500550

DYNEX POWER INC.
99 Bank Street, Suite 410,
Ottawa, Ontario, Canada, K1P 6B9
Tel: 613.723.7035
Fax: 613.723.1518
Toll Free: 1.888.33.DYNEX (39639)

CUSTOMER SERVICE CENTRES
Central Europe Tel: +33 (0)1 58 04 91 00. Fax: +33 (0)1 46 38 51 33
North America Tel: 011-800-5554-5554. Fax: 011-800-5444-5444
UK, Scandinavia & Rest Of World Tel: +44 (0)1522 500500. Fax: +44 (0)1522 500020

SALES OFFICES
Central Europe Tel: +33 (0)1 58 04 91 00. Fax: +33 (0)1 46 38 51 33
North America Tel: (613) 723-7035. Fax: (613) 723-1518. Toll Free: 1.888.33.DYNEX (39639) /
Tel: (949) 733-3005. Fax: (949) 733-2986.
UK, Scandinavia & Rest Of World Tel: +44 (0)1522 500500. Fax: +44 (0)1522 500020

These offices are supported by Representatives and Distributors in many countries world-wide.
© Dynex Semiconductor 2001 Publication No. DS5358-2 Issue No. 2.1 March 2001
TECHNICAL DOCUMENTATION – NOT FOR RESALE. PRINTED IN UNITED KINGDOM

Datasheet Annotations:

Dynex Semiconductor annotate datasheets in the top right hand corner of the front page, to indicate product status. The annotations are as follows:-

Target Information: This is the most tentative form of information and represents a very preliminary specification. No actual design work on the product has been started.

Preliminary Information: The product is in design and development. The datasheet represents the product as it is understood but details may change.

Advance Information: The product design is complete and final characterisation for volume production is well in hand.

No Annotation: The product parameters are fixed and the product is available to datasheet specification.

This publication is issued to provide information only which (unless agreed by the Company in writing) may not be used, applied or reproduced for any purpose nor form part of any order or contract nor to be regarded as a representation relating to the products or services concerned. No warranty or guarantee express or implied is made regarding the capability, performance or suitability of any product or service. The Company reserves the right to alter without prior notice the specification, design or price of any product or service. Information concerning possible methods of use is provided as a guide only and does not constitute any guarantee that such methods of use will be satisfactory in a specific piece of equipment. It is the user's responsibility to fully determine the performance and suitability of any equipment using such information and to ensure that any publication or data used is up to date and has not been superseded. These products are not suitable for use in any medical products whose failure to perform may result in significant injury or death to the user. All products and materials are sold and services provided subject to the Company's conditions of sale, which are available on request.

All brand names and product names used in this publication are trademarks, registered trademarks or trade names of their respective owners.

Caution: This device is sensitive to electrostatic discharge. Users should follow ESD handling procedures.

www.dynexsemi.com