



Smart, simple solutions for the 12 most common design concerns

NXP I²C-bus solutions
2H 2011



I²C-bus: The serial revolution

By replacing complex parallel interfaces with a straightforward yet powerful serial structure, the I²C-bus revolutionized chip-to-chip communications.

Invented by NXP (Philips) more than 30 years ago, the I²C-bus uses a simple two-wire format to carry data one bit at a time. It performs inter-chip addressing, selection, control, and data transfer. Speeds are up to 400 kHz (Fast-mode), 1 MHz (Fast-mode Plus), 3.4 MHz (High Speed-mode), or 5 MHz (Ultra Fast-mode).

The I²C-bus shrinks the IC footprint and leads to lower IC costs. Plus, since far fewer copper traces are needed, it enables a smaller PCB, reduces design complexity, and lowers system cost.

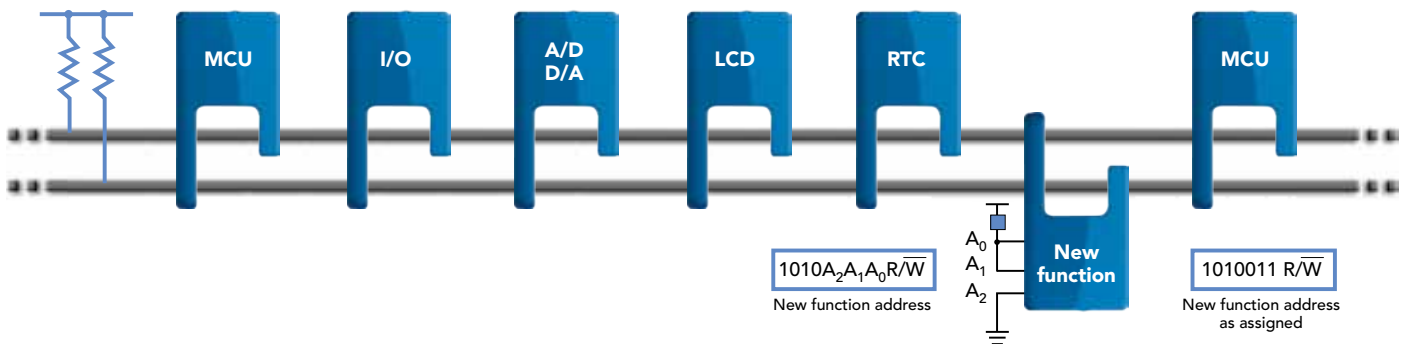
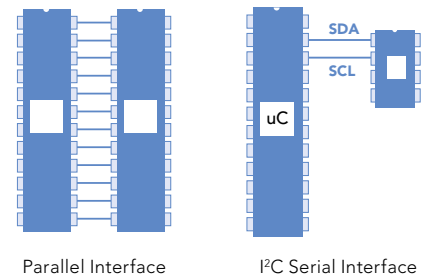

I²C-bus devices are available in a wide range of functions. Each slave device has its own I²C-bus address, selectable using address pins set high (1) or low (0). Information is transmitted byte by byte, and each byte is acknowledged by the receiver. There can be multiple devices on the same bus, and more than one IC can act as master. The master role is typically played by a microcontroller.

Write data

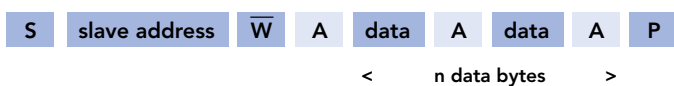

Read data

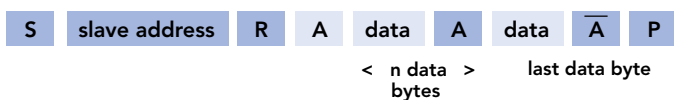

S = Start condition R/W-bar = read/write
 A = Acknowledge A-bar = Not acknowledge P = Stop condition

Master



The master always sends the clock

NXP's I²C peripherals portfolio is grouped into twelve families, one for each of the most common, everyday design concerns.

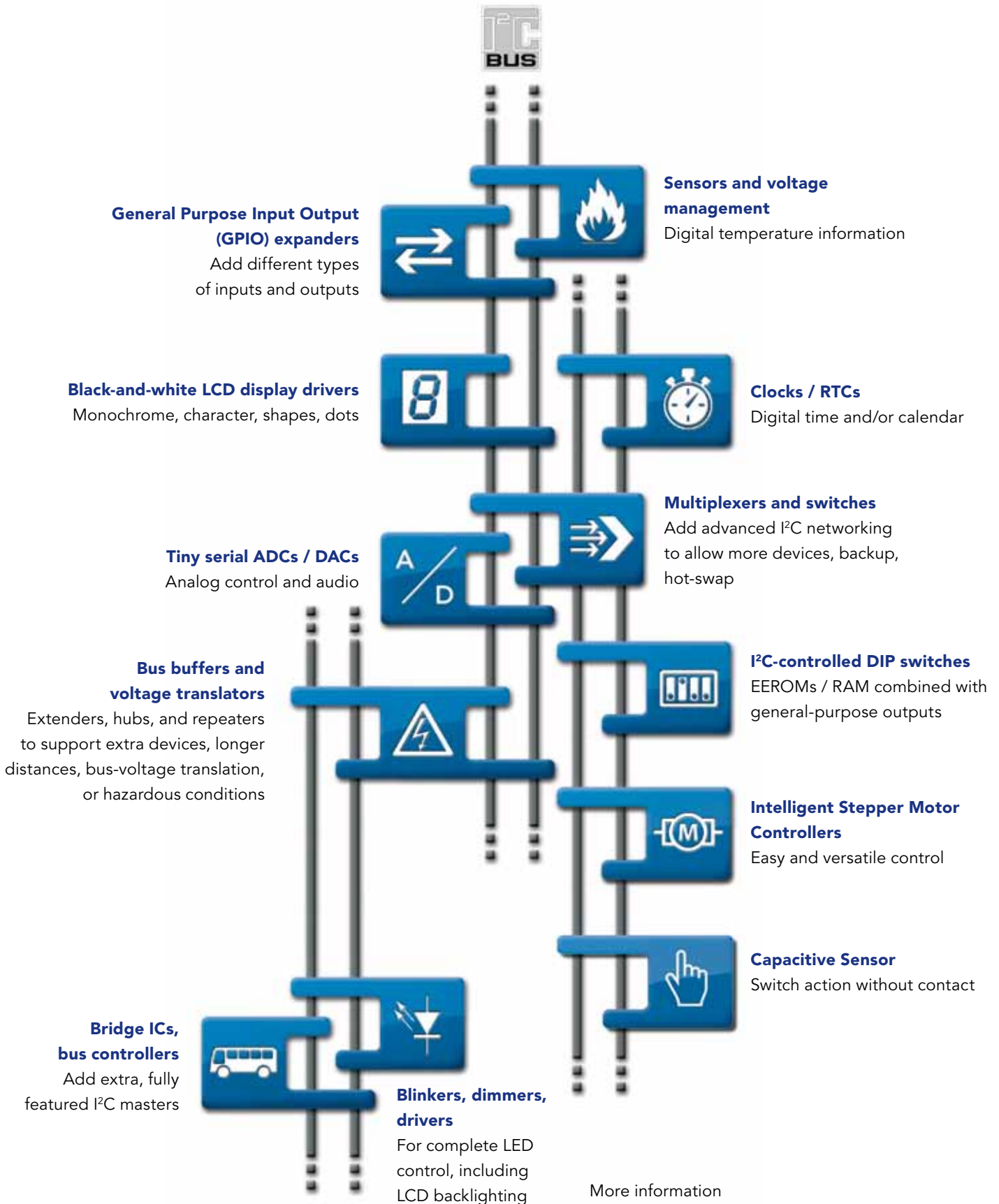

More information
www.nxp.com/interface

I²C-bus product summary

GPIO Expander		
4-bit	PCA9536	4-bit I ² C Fm TP GPIO with PU
	PCA9537	4-bit I ² C Fm TP GPIO with INT and RST
8-bit	PCA8574	8-bit I ² C Fm QB GPIO with INT and PU
	PCA8574A	8-bit I ² C Fm QB GPIO with INT and PU (Alternate address)
	PCA9500	8-bit I ² C Fm QB GPIO with PU and 2-K EEPROM
	PCA9501	8-bit I ² C Fm QB GPIO with INT, PU and 2-K EEPROM
	PCA9502	8-bit I ² C Fm/SPI TP GPIO with INT and RST
	PCA9534	8-bit I ² C Fm TP GPIO with INT
	+ PCA9538	8-bit I ² C Fm TP GPIO with INT and RST
	+ PCA9554	8-bit I ² C Fm TP GPIO with INT and PU
	PCA9554A	8-bit I ² C Fm TP GPIO with INT and PU (Alternate address)
	PCA9557	8-bit I ² C Fm TP GPIO with RST
	PCA9574	8-bit I ² C Fm LV VLT TP/OD GPIO with INT, RST, latch and PU/PD
	PCA9621	8-bit I ² C Fm+ 65 mA OD GPO with RST
	PCA9670	8-bit I ² C Fm+ QB GPIO with RST and PU
	PCA9672	8-bit I ² C Fm+ QB GPIO with INT, RST and PU
	PCA9674	8-bit I ² C Fm+ QB GPIO with INT and PU
	PCA9674A	8-bit I ² C Fm+ QB GPIO with INT and PU (Alternate address)
	PCF8574	8-bit I ² C Sm QB GPIO with INT and PU
	PCF8574A	8-bit I ² C Sm QB GPIO with INT and PU (Alternate address)
16-bit	PCA6416A	16-bit I ² C Fm LV VLT TP GPIO with INT and RST
	PCA8575	16-bit I ² C Fm QB GPIO with INT and PU
	PCA9535	16-bit I ² C Fm TP GPIO with INT
	PCA9535A	16-bit I ² C Fm LV TP GPIO with INT
	PCA9535C	16-bit I ² C Fm OD GPIO with INT
	+ PCA9539	16-bit I ² C Fm TP GPIO with INT and RST
	PCA9539A	16-bit I ² C Fm LV TP GPIO with INT and RST
	PCA9539R	16-bit I ² C Fm TP GPIO with INT and RST (state machine only)
	PCA9555	16-bit I ² C Fm TP GPIO with INT and PU
	PCA9555A	16-bit I ² C Fm LV TP GPIO with INT and PU
	PCA9575	16-bit I ² C Fm LV VLT TP/OD GPIO with INT, RST, latch and PU/PD
	PCA9671	16-bit I ² C Fm+ QB GPIO with RST and PU
	PCA9673	16-bit I ² C Fm+ QB GPIO with INT, RST and PU
	PCA9675	16-bit I ² C Fm+ QB GPIO with INT and PU
	PCA-L6416A	16-bit I ² C Fm LV VLT TP/OD GPIO with INT, RST, latch and PU/PD
	PCA-L9535A	16-bit I ² C Fm LV TP/OD GPIO with INT, latch and PU/PD
	PCA-L9539A	16-bit I ² C Fm LV TP/OD GPIO with INT, RST, latch and PU/PD
	PCA-L9555A	16-bit I ² C Fm LV TP/OD GPIO with INT, latch and PU/PD (PU default)
PCF8575	16-bit I ² C Fm QB GPIO with INT and PU	
PCF8575C	16-bit I ² C Fm OD GPIO with INT	
40-bit	PCA9505	40-bit I ² C Fm TP GPIO with INT, RST, OE and PU
	PCA9506	40-bit I ² C Fm TP GPIO with INT, RST and OE
	PCA9698	40-bit I ² C Fm+ TP/OD GPIO with INT, RST, OE and PU

Stepper Motor Controller		
1 motor controller	PCA9629	I ² C Fm+ Stepper Motor Controller with TP GPIO with INT and RST

Capacitive Sensor		
8-channel touch switch	+ PCA/PCF8885	I ² C FM Touch / Proximity Sensor for up to 28 keys

Temp sensors		
Local	LM75A	I ² C Fm TS local with ± 2 °C accuracy
	LM75B	I ² C Fm TS local with ± 2 °C accuracy and SMBus time-out
	SE95	I ² C Fm TS local with ± 1 °C accuracy
	SE98A	I ² C Fm DDR TS local with ± 1 °C accuracy and SMBus time-out
Local and EEPROM	SE97B	I ² C Fm DDR TS local with ± 1 °C accuracy, 2K SPD and SMBus time-out
Local and remote	NE1617A	I ² C Fm TS local with ± 2 °C accuracy and remote with ± 3 °C accuracy
	SA56004	I ² C Fm TS local with ± 2 °C accuracy and remote with ± 1 °C accuracy
Local, remote, and voltage monitor	NE1619	I ² C Fm TS local with ± 2 °C accuracy and remote with ± 3 °C accuracy with voltage monitor w(12, 5, 3.3, and 2.5 V, V _{CCP} and V _{DD})

LED controllers		
Dimmer (2 PWM, 25 mA / 5 V)	PCA9530	2-channel I ² C Fm OD LED dimmer with RST
	PCA9531	8-channel I ² C Fm OD LED dimmer with RST
	PCA9532	16-channel I ² C Fm OD LED dimmer with RST
	PCA9533	4-channel I ² C Fm OD LED dimmer
Blinker (2 PWM, 25 mA / 5 V)	PCA9550	2-channel I ² C Fm OD LED blinker with RST
	PCA9551	8-channel I ² C Fm OD LED blinker with RST
	PCA9552	16-channel I ² C Fm OD LED blinker with RST
	PCA9553	4-channel I ² C Fm OD LED blinker
8-segment	SAA1064	16-channel I ² C Sm current source/sink 4x8-segment LED display
Controller (PWM / Ch, 25 mA / 5 V)	PCA9632	4-channel I ² C Fm+ low-power TP LED controller
	PCA9633	4-channel I ² C Fm+ TP LED controller with OE
	PCA9634	8-channel I ² C Fm+ TP LED controller with OE
	+ PCA9635	16-channel I ² C Fm+ TP LED controller with OE
	+ PCA9685	16-channel I ² C Fm+ TP LED controller with 12-bit PWMs and OE
Controller (PWM / Ch, 57 mA / 40 V)	PCA9952	16-channel I ² C Fm+ HV CS LED controller with OE
	PCA9955	16-channel I ² C Fm+ HV CS LED controller
	PCU9955	16-channel I ² C UFm HV CS LED controller
Controller (PWM / Ch, 100 mA / 40 V)	PCA9624	8-channel I ² C Fm+ HV OD LED controller with OE
	PCA9622	16-channel I ² C Fm+ HV OD LED controller with OE
	PCA9626	24-channel I ² C Fm+ HV OD LED controller with OE
	PCU9654	8-channel I ² C UFm HV OD LED controller with OE
	PCU9655	16-channel I ² C UFm HV OD LED controller
	PCU9656	24-channel I ² C UFm HV OD LED controller with OE
LED flash	SSL3250A	I ² C Fm 500 mA sink dual LED flash with torch mode
	SSL3252	I ² C Fm 500 mA source dual LED flash with torch mode

Real-time clocks 		
Low-power	PCA8802	I ² C Fm RTC for One Time Password generation and smart cards
	PCF8523	I ² C Fm+ Ultra low-power RTC with loss of main power detect and auto battery switch over
	PCF8563	I ² C Fm Ultra low-power clock/calendar
	PCF8564A	I ² C Fm Ultra low-power clock/calendar and COB
Normal	+ PCA8565	I ² C Fm High temperature clock/calendar -40°C...+125°C
	PCF8583	I ² C Sm Clock/calendar resolution: 0.01 s, with 256x8 SRAM
	PCF8593	I ² C Sm Low-power clock/calendar resolution: 0.01 s
Temp-compensated	PCF2127A	I ² C Fm High-accuracy, low-voltage RTC with 512x8 RAM
	+ PCA/PCF2129(A)	I ² C Fm High-accuracy RTC

Muxes and switches 		
2-channel	PCA9540B	2-channel I ² C Fm mux
	PCA9542A	2-channel I ² C Fm mux with INT
	PCA9543A/B/C	2-channel I ² C Fm switch with INT and RST (B and C Alternate address)
2-to-1 demux	PCA9541A/01	2 to 1 I ² C Fm demux with INT and RST (channel 0 default)
	PCA9541A/03	2 to 1 I ² C Fm demux with INT and RST (no channel default)
4-channel	PCA9544A	4-channel I ² C Fm mux with INT
	PCA9545A/B/C	4-channel I ² C Fm switch with INT and RST (B and C Alternate address)
	PCA9546A	4-channel I ² C Fm switch with RST
	PCA9646	4-channel I ² C Fm+ No Offset buffer/switch with RST
8-channel	PCA9547	8-channel I ² C Fm mux with RST (channel 0 default)
	PCA9548A	8-channel I ² C Fm switch with RST

Bus buffers 		
Incremental Offset	PCA9510A	I ² C Fm Incremental Offset hot-swap bus buffer (no RTA)
	PCA9511A	I ² C Fm Incremental Offset hot-swap bus buffer
	PCA9512B	I ² C Fm Incremental Offset VLT hot-swap bus buffer
	PCA9513A	I ² C Fm Incremental Offset hot-swap bus buffer (92 µA CS)
	PCA9514A	I ² C Fm Incremental Offset hot-swap bus buffer (0.8 V offset)
	PCA9521	I ² C Fm (1 MHz) HV Incremental Offset bus buffer
	PCA9522	I ² C Fm (1 MHz) HV Incremental Offset hot-swap bus buffer
Amplifier	P82B715	I ² C Fm HV bus extender
No Offset	PCA9525	I ² C Fm (1 MHz) No Offset bus repeater
	PCA9605	I ² C Fm+ No Offset bus repeater
Static Offset (1 side)	P82B96	I ² C Fm HV bus buffer
	PCA9507	I ² C Fm VLT DDC buffer with accelerator
	PCA9508	I ² C Fm VLT hot-swap bus repeater
	PCA9509	I ² C Fm 1.0V LV VLT bus buffer with current source
	PCA9509A	I ² C Fm 0.8V LV VLT bus buffer with current source
	PCA9509P	I ² C Fm 0.8V LV VLT bus buffer
	PCA9517A	I ² C Fm 0.9V LV VLT bus repeater
	PCA9519	4-channel version of PCA9509
	PCA9527	I ² C Fm DDC VLT buffer with accelerator and CEC
	PCA9600	I ² C Fm+ HV bus buffer
	PCA9601	I ² C Fm+ HV bus buffer with stronger 15 mA local side drive to support multiple Fm+ slaves
Static Offset (All sides)	PCA9515A	I ² C Fm bus repeater
	PCA9516A	I ² C Fm 5-channel hub
	PCA9518A	I ² C Fm expandable 5-channel hub
Voltage translator (doesn't isolate capacitance)	GTL2000	22-bit I ² C Fm+ VLT
	GTL2002	2-bit I ² C Fm+ VLT
	GTL2003	8-bit I ² C Fm+ VLT
	GTL2010	10-bit I ² C Fm+ VLT
	PCA9306	Dual I ² C/SMBus Fm+ VLT
	NVT2001	1-bit I ² C Fm+ VLT
	NVT2002	2-bit I ² C Fm+ VLT for I ² C/SMBus applications
	NVT2003	3-bit I ² C Fm+ VLT for two power supply applications
	NVT2004	4-bit I ² C Fm+ VLT for SPI applications
	NVT2006	6-bit I ² C Fm+ VLT
	NVT2008	8-bit I ² C Fm+ VLT
NVT2010	10-bit I ² C Fm+ VLT	

Decode table

	Bus Speed		Features
Sm	100 kHz Standard-mode I ² C-bus	LV	Supply voltage <2.3 V
Fm	400 kHz Fast-mode I ² C-bus	TP	Totem-pole (push-pull)
Fm+	1 MHz Fast-mode Plus I ² C-bus	QB	Quasi-bidirectional
HSm	3.4 MHz High Speed-mode I ² C-bus	OD	Open drain
UFm	5 MHz Ultra Fast-mode I ² C-bus	CS	Current source
		INT	Interrupt
		RST	Reset
+	AEC-Q100 compliance		
GPIO	General Purpose I/O Expander	OE	Output enable
TS	Thermal Sensor	Latch	Input latch
RTC	Real Time Clock	PU	Pull-up resistors
LCD	Liquid Crystal Display	PU/PD	Pull-up/pull-down resistors
DAC	Digital Analog Converter	HV	Outputs >10 V
ADC	Analog Digital Converter	VLT	Voltage Level Translator – 2 Supplies
		COG	Chip on Glass

LCD drivers		
Character driver	PCF2113	I ² C Fm 1/2-line, 12-character, 120-icon LCD driver
	PCF2116	I ² C Sm 1/2-line, 24 characters per line, or 2/4 line, 12 characters per line
	PCF2119	I ² C Fm 1/2-line, 16-character, 160-icon LCD driver
Graphic driver	PCF8531	I ² C Fm 34 x 128-pixel LCD driver
	PCF8578	I ² C Sm Dot-matrix LCD driver (row/column)
	PCF8579	I ² C Sm Dot-matrix LCD driver (column)
	PCF8811	I ² C Hsm 80 x 128-pixel LCD driver
Segment driver	PCF8577C	I ² C Sm 64-segment LCD driver
	PCF8566	I ² C Sm 96-segment LCD driver
	+ PCA/PCF85162	I ² C Fm 128-segment LCD driver
	+ PCA/PCF85176	I ² C Fm 160-segment LCD driver
	+ PCA/PCF85134	I ² C Fm 240-segment LCD driver
	+ PCA/PCF85133	I ² C Fm 320-segment, COG LCD driver
	+ PCA/PCF8536	I ² C Fm 320-segment plus LED backlight control
	PCF8578	I ² C Sm 384-segment LCD driver
	+ PCA9620	I ² C Fm 480-segment LCD driver
	+ PCA/PCF85132	I ² C Fm 640-segment COG LCD driver
	+ PCA85232	I ² C Fm 640-segment COG LCD driver

Bridge and bus controllers		
Bridge	SC16IS740	I ² C Fm/SPI-to-UART bridge with IrDA
	SC16IS741	I ² C Fm/SPI-to-UART bridge with IrDA
	SC16IS750	I ² C Fm/SPI-to-UART bridge with IrDA and GPIO
	SC16IS752	I ² C Fm/SPI-to-DUART bridge with IrDA and GPIO
	SC16IS760	I ² C Fm/SPI-to-UART bridge with IrDA and GPIO
	SC16IS762	I ² C Fm/SPI-to-DUART bridge with IrDA and GPIO
	SC18IM700	UART-to-I ² C Fm master bridge with GPIO
	SC18IS600	SPI-to-I ² C Fm master bridge, 4 M with GPIO
	SC18IS602	I ² C Fm slave-to-SPI master bridge
	Controller	PCF8584
PCA9564		I ² C Fm bus controller
PCA9661		1-channel I ² C Fm+ bus controller with 4 K-byte buffer
PCA9663		3-channel I ² C Fm+ bus controller with 4 K-byte buffer per channel
PCA9665		I ² C Fm+ bus controller with 68-byte buffer
PCA9665A		I ² C Fm+ bus controller with 68-byte buffer and restart condition fix
PCU9661		1-channel U ² C Fm bus controller with 4 K-byte buffer
PCU9669		1-channel Fm+ and 2-channel U ² C Fm bus controller with 4 K-byte buffer per channel

A/D-D/A converters		
8-bit ADC	PCF8591	I ² C Sm 4-channel ADC and 1-channel DAC

EEPROMs		
2-kbit	PCF85102C	I ² C Sm 256 x 8-bit EEPROM (No programming time control output)
	PCF85103C	I ² C Sm 256 x 8-bit EEPROM (No programming time control output with ALT address)
	PCF8582C	I ² C Sm 256 x 8 EEPROM
	PCF8570	I ² C Sm 256 x 8-bit RAM
4-kbit	PCF8594C	I ² C Sm 1024 x 8-bit EEPROM
	SL3S4001	I ² C Fm 3.6K bit EEPROM with dual Gen2 RFID interface
8-kbit	PCA24S08A	I ² C Fm 1024 x 8-bit EEPROM with access protection
	PCF8598C	I ² C Sm 1024 x 8-bit EEPROM
DIP switch	PCA8550	I ² C Fm 4-bit 1-of-2 mux & 5-bit EEPROM
	PCA9558	I ² C Fm 5-bit MP/1-bit latch & 6-bit EEPROM with 2K EEPROM and 8-bit GPIO
	PCA9559	I ² C Fm 5-bit mux/1-bit latch & 6-bit EEPROM
	PCA9560	I ² C Fm 2 x 5-bit mux/1-bit latch & 6-bit EEPROM
	PCA9561	I ² C Fm 4 x 6-bit mux & 6-bit EEPROM

Demo boards		
e-Tools	OM6270	SPI/I ² C-to-UART bridge demo (SC16IS750)
	OM6271	SPI-to-I ² C-master bridge demo (SC18IS600)
	OM6272	UART-to-I ² C-master bridge demo (SC18IM700)
	OM6273	SPI/I ² C-to-DUART/IrDA/GPIO demo (SC16IS752)
	OM6274	I ² C-to-SPI-master bridge demo (SC18IS602)
	OM6275	I ² C 2005-1 evaluation board
	OM6276	PCA9633 demo board
	OM6277	PCA9564 evaluation board
	OM6278	I ² C 2002-1A evaluation board
	OM6281	PCA9698 daughter card for I ² C 2005-1
	OM6282	PCA9633 daughter card for I ² C 2005-1
	OM6285	I ² C 2002-1A evaluation board without PC controller board
	OM6290	LCD driver evaluation board: PCF8576D, PCF2119, PCF8531, PCA9633
	OM6292	PCA21125, PCF8562 demoboard
	OM6293	PCA9600 daughter card for I ² C 2005-1
	OM6297	PCF2123, PCF8562 demoboard
	OM11051	PCF2127A demo board
	OM11057	PCF8885/86 capacitive sensor and PCF8536 LCD/LED driver
	OM13260	I ² C Fm+ development board (RoHS)
	OM13243	PCA9555 daughter card (RoHS)
OM13243	GPIO target board (RoHS)	
OM13257	LM75B daughter card (RoHS)	
OM13285	PCA9629 demo board	
OM13320	I ² C Fm+ development kit (RoHS)	

OM6275
I²C 2005-1 evaluation board



OM6278
I²C 2002-1A evaluation board



OM6277
PCA9564 evaluation board



OM6293
PCA9600 daughter card for I²C 2005-1



OM6276
PCA9633 demo board



Our I²C-bus website (www.nxp.com/interface) is a valuable resource for device information and training programs. It gives you direct access to a comprehensive handbook, application notes, information about evaluation kits and training materials, links to application and design support, and more.

The I²C Fm+ development board and daughter cards make it easy to program new peripherals and are a quick way to learn about the I²C-bus protocol.

OM13320 Fm+ Demonstration Kit which includes the OM13260 Fm+ Development Board with two OM13303 GPIO Target Boards and one each of the OM13243 PCA9555 GPIO 16-bit and OM13257 LM75B Thermal Sensor daughter boards



OM13285 PCA9629 stepper motor demonstration board

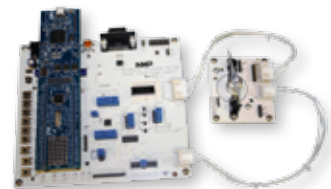

OM11057 PCF8885/86 touch switch with PCF8536 LCD/LED driver





www.nxp.com/interface

©2011 NXP Semiconductors N.V.

All rights reserved. Reproduction in whole or in part is prohibited without the prior written consent of the copyright owner. The information presented in this document does not form part of any quotation or contract, is believed to be accurate and reliable and may be changed without notice. No liability will be accepted by the publisher for any consequence of its use. Publication thereof does not convey nor imply any license under patent- or other industrial or intellectual property rights.

Date of release: August 2011

Document order number: 9397 750 17144

Printed in the Netherlands