



H07N65 Series

N-Channel Power Field Effect Transistor

Description

This high voltage MOSFET uses an advanced termination scheme to provide enhanced voltage-blocking capability without degrading performance over time. In addition, this advanced MOSFET is designed to withstand high energy in avalanche and commutation modes. The new energy efficient design also offers a drain-to-source diode with a fast recovery time. Designed for high voltage, high speed switching applications in power supplies, converters and PWM motor controls, these devices are particularly well suited for bridge circuits where diode speed and commutating safe operating areas are critical and offer additional and safety margin against unexpected voltage transients.

Features

- Robust High Voltage Termination
- Avalanche Energy Specified
- Source-to-Drain Diode Recovery Time Comparable to a Discrete Fast Recovery Diode
- Diode is Characterized for Use in Bridge Circuits
- IDSS and $V_{DS(on)}$ Specified at Elevated Temperature

Absolute Maximum Ratings

Symbol	Parameter	Value	Units
V_{DS}	Drain-Source Voltage	650	V
I_D	Drain to Current (Continuous)	7	A
I_{DM}	Drain to Current (Pulsed)	28	A
V_{GS}	Gate-to-Source Voltage (Continue)	± 30	V
P_D	Total Power Dissipation ($T_C=25^\circ\text{C}$) H07N65E (TO-220AB)	120	W
	H07N65F (TO-220FP)	48	W
	Derate above 25°C H07N65E (TO-220AB)	1.18	W/ $^\circ\text{C}$
	H07N65F (TO-220FP)	0.38	W/ $^\circ\text{C}$
T_j	Operating Temperature Range	-55 to 150	$^\circ\text{C}$
T_{stg}	Storage Temperature Range	-55 to 150	$^\circ\text{C}$
E_{AS}	Single Pulse Drain-to-Source Avalanche Enrgy- $T_j=25^\circ\text{C}$ ($V_{DD}=50\text{V}$, $V_{GS}=10\text{V}$, $I_L=7\text{A}$, $L=10\text{mH}$, $R_G=25\Omega$)	530	mJ
T_L	Maximum Lead Temperature for Soldering Purposes, 1/8" from case for 10 seconds	260	$^\circ\text{C}$

Note: 1. $V_{DD}=50\text{V}$, $I_D=7\text{A}$

2. Pulse Width and frequency is limited by $T_{j(max)}$ and thermal response

H07N65 Series Pin Assignment

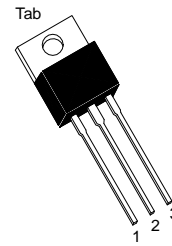

3-Lead Plastic **TO-220AB**
Package Code: E
Pin 1: Gate
Pin 2 & Tab: Drain
Pin 3: Source

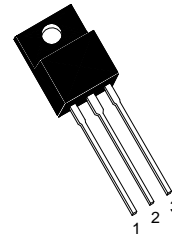

3-Lead Plastic **TO-220FP**
Package Code: F
Pin 1: Gate
Pin 2: Drain
Pin 3: Source

H07N65 Series
Symbol:

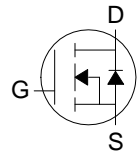



Thermal Characteristics

Symbol	Parameter	Value		Units
R θ_{JC}	Thermal Resistance Junction to Case Max.	TO-220AB	1.02	
		TO-220FP	3.3	
R θ_{JA}	Thermal Resistance Junction to Ambient Max.	62		$^{\circ}\text{C/W}$

Electrical Characteristics (T_J=25 $^{\circ}\text{C}$, unless otherwise specified)

Symbol	Characteristic	Min.	Typ.	Max.	Unit
V _{(BR)DSS}	Drain-Source Breakdown Voltage (V _{GS} =0V, I _D =250 μA)	650	-	-	V
I _{DSS}	Drain-Source Leakage Current (V _{DS} =650V, V _{GS} =0V)	-	-	1	μA
	Drain-Source Leakage Current (V _{DS} =650V, V _{GS} =0V, T _J =125 $^{\circ}\text{C}$)	-	-	50	μA
I _{GSSF}	Gate-Source Leakage Current-Forward (V _{gsf} =30V, V _{DS} =0V)	-	-	100	nA
I _{GSSR}	Gate-Source Leakage Current-Reverse (V _{gsr} =-30V, V _{DS} =0V)	-	-	-100	nA
V _{GS(th)}	Gate Threshold Voltage (V _{DS} =V _{GS} , I _D =250 μA)	2	3	4	V
R _{DS(on)}	Static Drain-Source On-Resistance (V _{GS} =10V, I _D =3.5A)*	-	1	1.2	Ω
g _{FS}	Forward Transconductance (V _{DS} =15V, I _D =3.5A)*	2	-	-	S
C _{iss}	Input Capacitance	-	1095	-	pF
C _{oss}	Output Capacitance	-	95	-	
C _{rss}	Reverse Transfer Capacitance	-	3	-	
t _{d(on)}	Turn-on Delay Time	-	39	-	ns
t _r	Rise Time	-	29	-	
t _{d(off)}	Turn-off Delay Time	-	249	-	
t _f	Fall Time	-	37	-	
Q _g	Total Gate Charge	-	27	38	nC
Q _{gs}	Gate-Source Charge	-	5.1	-	
Q _{gd}	Gate-Drain Charge	-	8.5	-	

*: Pulse Test: Pulse Width $\leq 300\mu\text{s}$, Duty Cycle $\leq 2\%$

Source-Drain Diode

Symbol	Characteristic	Min.	Typ.	Max.	Units
V _{SD}	Forward On Voltage(1)	-	-	1.4	V
t _{rr}	Reverse Recovery Time	-	365	-	ns
Q _{rr}	Reverse Recovery Charge	-	3.5	-	ns

** : Negligible, Dominated by circuit inductance



Characteristics Curve

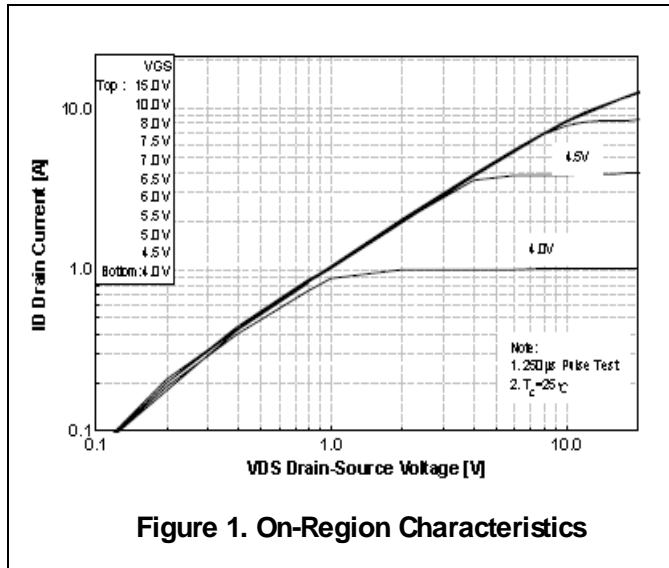

Figure 1. On-Region Characteristics

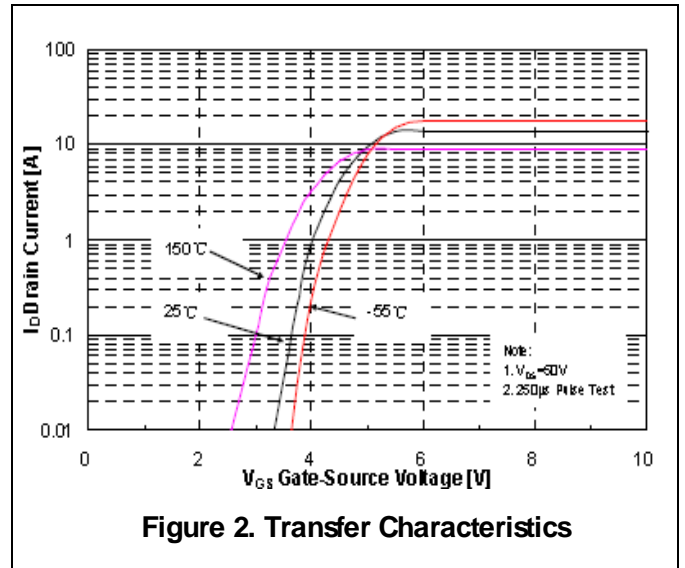

Figure 2. Transfer Characteristics

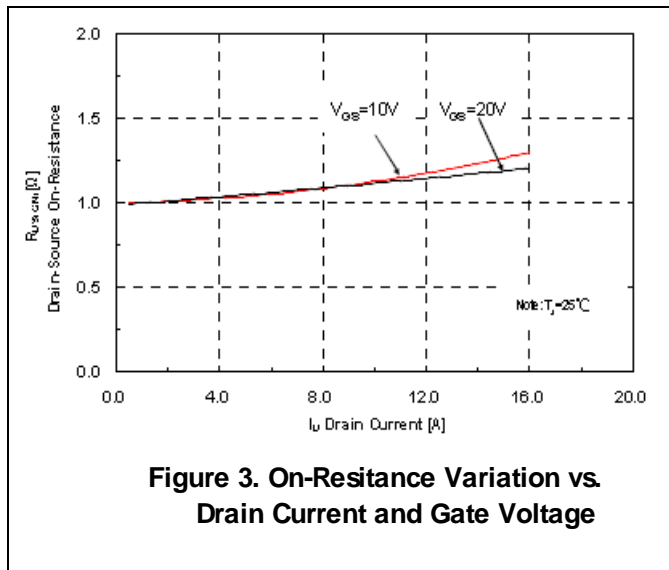

Figure 3. On-Resistance Variation vs. Drain Current and Gate Voltage

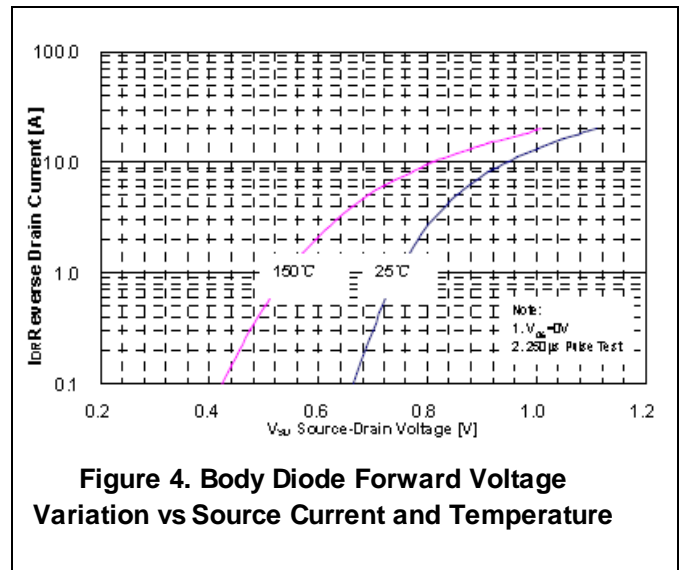

Figure 4. Body Diode Forward Voltage Variation vs Source Current and Temperature

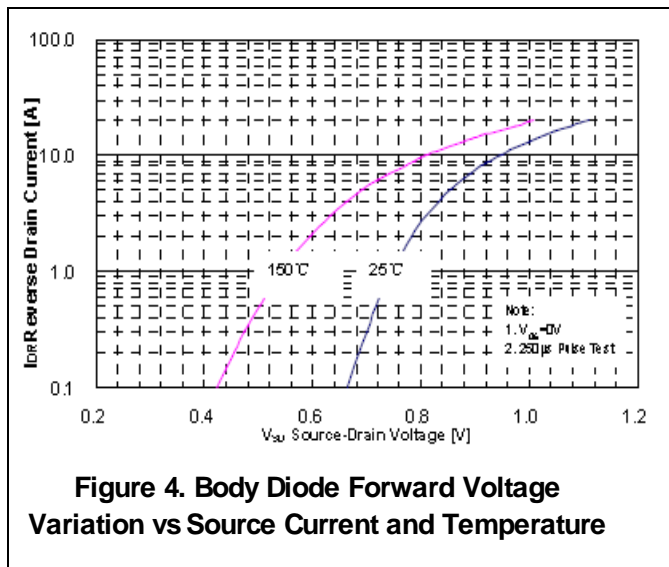

Figure 4. Body Diode Forward Voltage Variation vs Source Current and Temperature

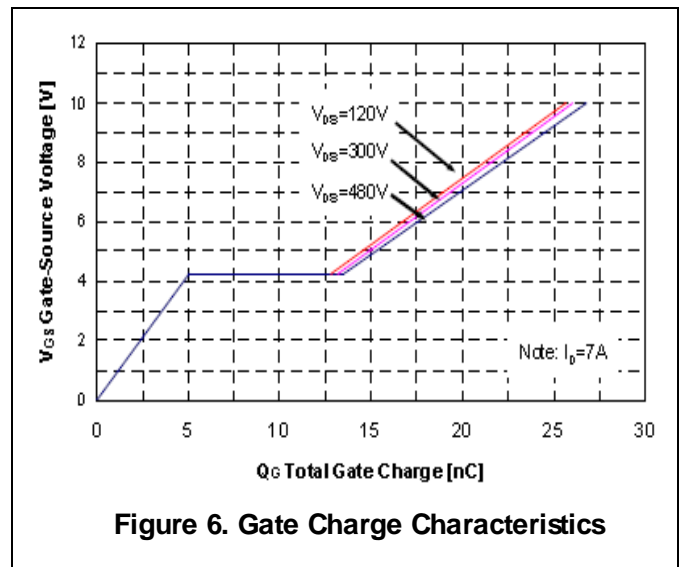
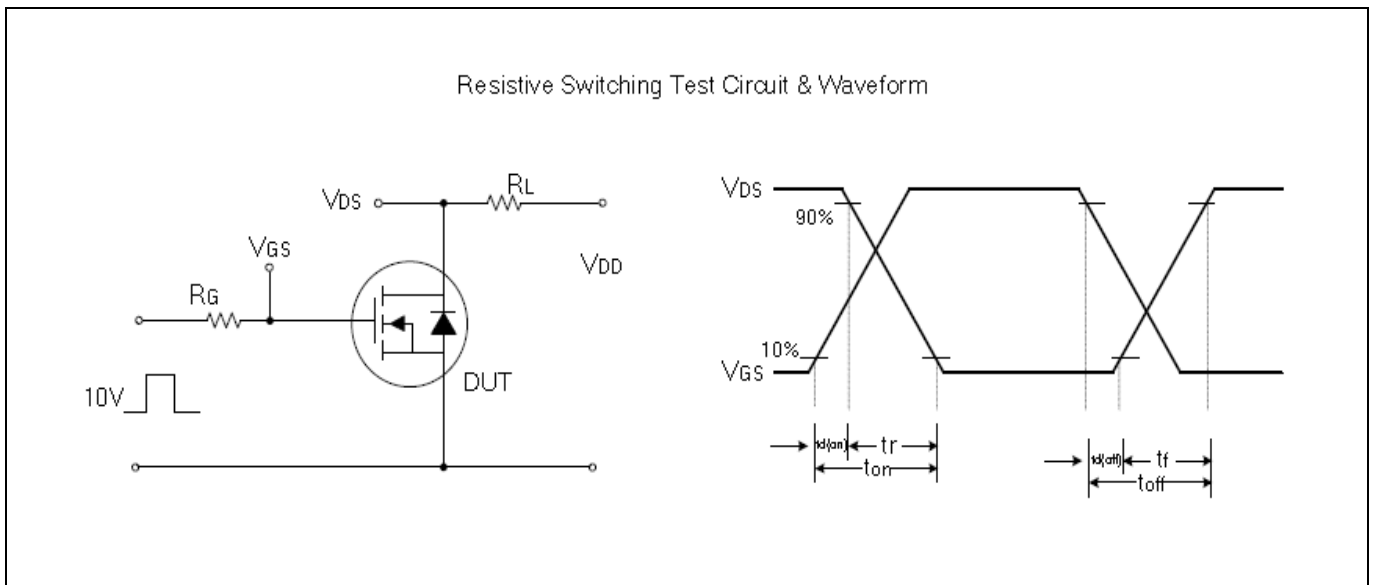
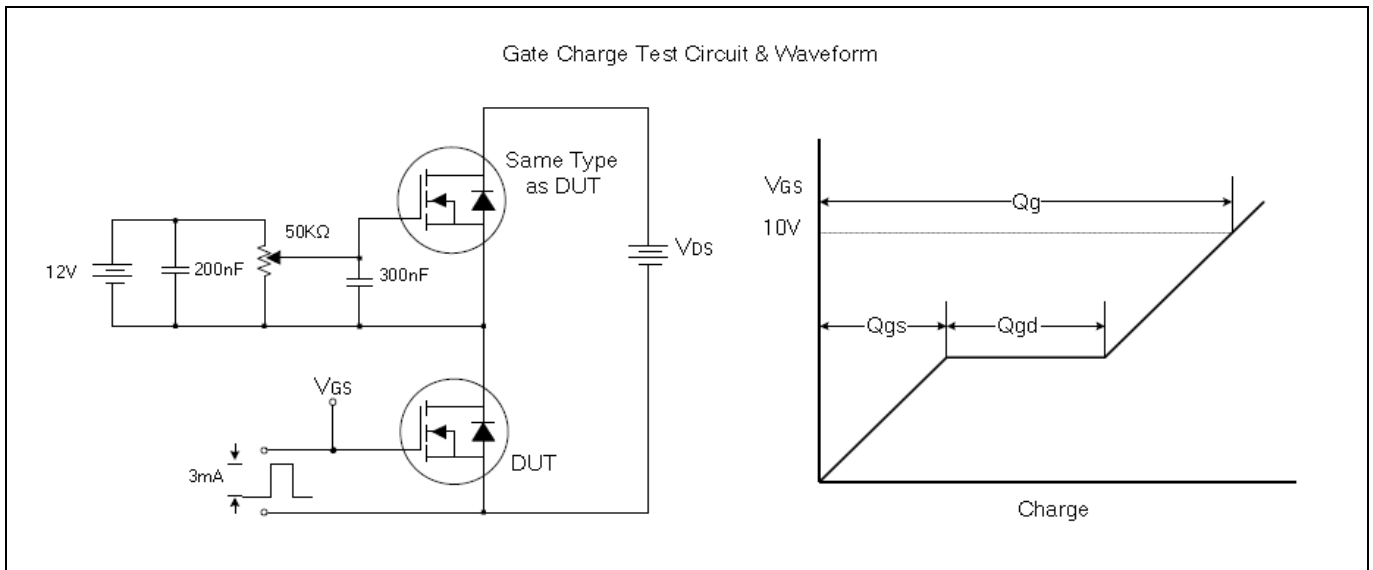
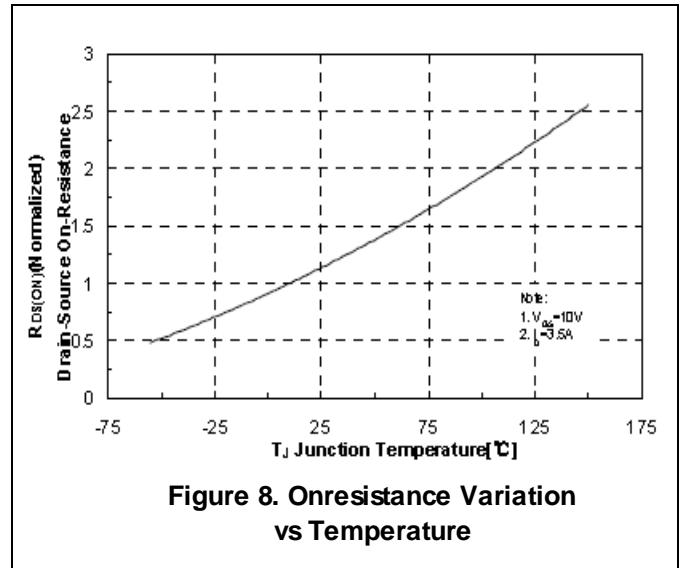
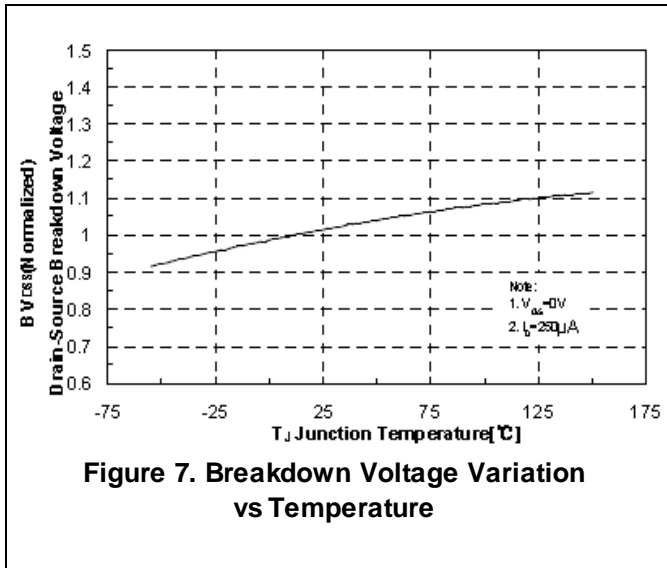

Figure 6. Gate Charge Characteristics



Characteristics Curve





TO-220AB Dimension

3-Lead TO-220AB
Plastic Package
HSMC Package Code: E

Marking:

Pb Free Mark
 Pb-Free: "●" (Note)
 Normal: None

Date Code Control Code

Note: Green label is used for pb-free packing

Pin Style: 1.Gate 2 & Tab.Drain 3.Source

Material:

- Lead solder plating: Sn60/Pb40 (Normal), Sn/3.0Ag/0.5Cu or Pure-Tin (Pb-free)
- Mold Compound: Epoxy resin family, flammability solid burning class: UL94V-0

DIM	Min.	Max.
A	5.58	7.49
B	8.38	8.90
C	4.40	4.70
D	1.15	1.39
E	0.35	0.60
F	2.03	2.92
G	9.66	10.28
H	-	*16.25
I	-	*3.83
J	3.00	4.00
K	0.75	0.95
L	2.54	3.42
M	1.14	1.40
N	-	*2.54
O	12.70	14.27
P	14.48	15.87

*: Typical, Unit: mm

TO-220FP Dimension

3-Lead TO-220FP
Plastic Package
HSMC Package Code: F

Marking:

Pb Free Mark
 Pb-Free: "●" (Note)
 Normal: None

Date Code Control Code

Note: Green label is used for pb-free packing

Pin Style: 1.Gate 2.Drain 3.Source

Material:

- Lead solder plating: Sn60/Pb40 (Normal), Sn/3.0Ag/0.5Cu or Pure-Tin (Pb-free)
- Mold Compound: Epoxy resin family, flammability solid burning class: UL94V-0

DIM	Min.	Max.
A	6.48	7.40
C	4.40	4.90
D	2.34	3.00
E	0.45	0.80
F	9.80	10.36
G	3.10	3.60
I	2.70	3.43
J	0.60	1.00
K	2.34	2.74
L	12.48	13.60
M	15.67	16.20
N	0.90	1.47
O	2.00	2.96
$\alpha 1/2/4/5$	-	*5°
$\alpha 3$	-	*27°

*: Typical, Unit: mm

Important Notice:

- All rights are reserved. Reproduction in whole or in part is prohibited without the prior written approval of HSMC.
- HSMC reserves the right to make changes to its products without notice.
- **HSMC semiconductor products are not warranted to be suitable for use in Life-Support Applications, or systems.**
- HSMC assumes no liability for any consequence of customer product design, infringement of patents, or application assistance.

Head Office And Factory:

- **Head Office** (Hi-Sincerity Microelectronics Corp.): 10F.,No. 61, Sec. 2, Chung-Shan N. Rd. Taipei Taiwan R.O.C.
 Tel: 886-2-2521-2056 Fax: 886-2-2563-2712
- **Factory 1:** No. 38, Kuang Fu S. Rd., Fu-Kou Hsin-Chu Industrial Park Hsin-Chu Taiwan. R.O.C
 Tel: 886-3-598-3621~5 Fax: 886-3-598-2931



Soldering Methods for HSMC's Products

1. Storage environment: Temperature=10°C~35°C Humidity=65%±15%
2. Reflow soldering of surface-mount devices

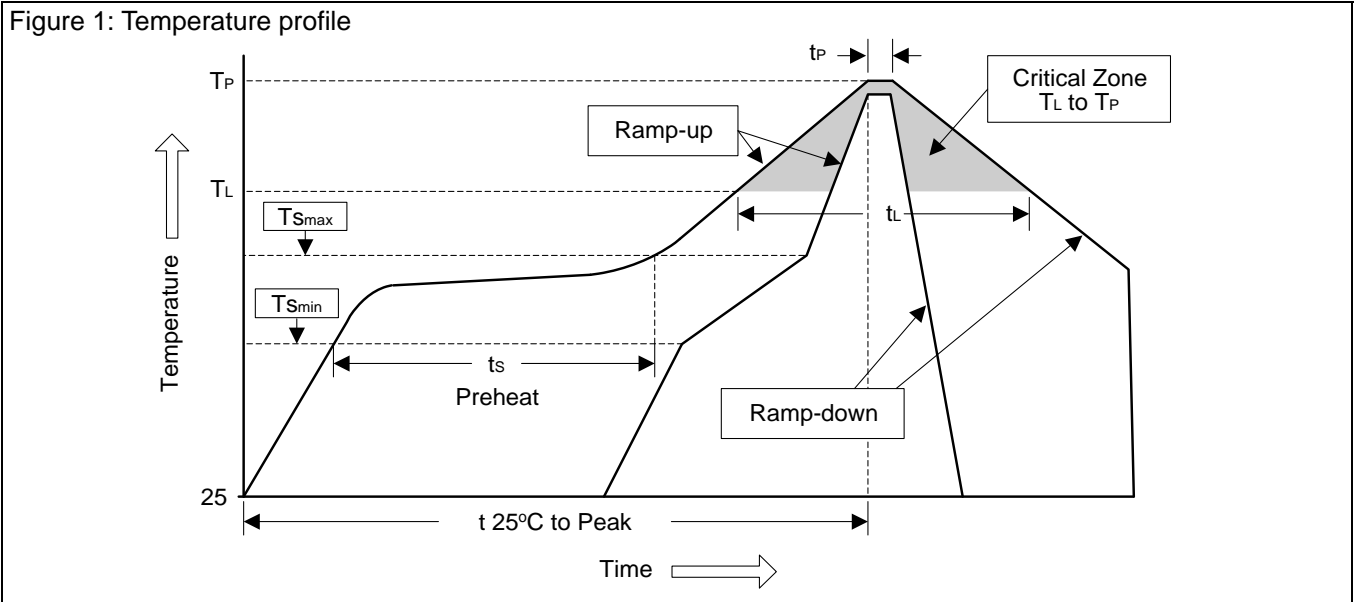

Profile Feature	Sn-Pb Eutectic Assembly	Pb-Free Assembly
Average ramp-up rate (T_L to T_P)	<3°C/sec	<3°C/sec
Preheat		
- Temperature Min (T_{Smin})	100°C	150°C
- Temperature Max (T_{Smax})	150°C	200°C
- Time (min to max) (t_s)	60~120 sec	60~180 sec
T_{Smax} to T_L		
- Ramp-up Rate	<3°C/sec	<3°C/sec
Time maintained above:		
- Temperature (T_L)	183°C	217°C
- Time (t_L)	60~150 sec	60~150 sec
Peak Temperature (T_P)	240°C +0/-5°C	260°C +0/-5°C
Time within 5°C of actual Peak Temperature (t_P)	10~30 sec	20~40 sec
Ramp-down Rate	<6°C/sec	<6°C/sec
Time 25°C to Peak Temperature	<6 minutes	<8 minutes

3. Flow (wave) soldering (solder dipping)

Products	Peak temperature	Dipping time
Pb devices.	245°C ±5°C	10sec ±1sec
Pb-Free devices.	260°C ±5°C	10sec ±1sec