

H11AG1 H11AG2 H11AG3

PACKAGE DIMENSIONS

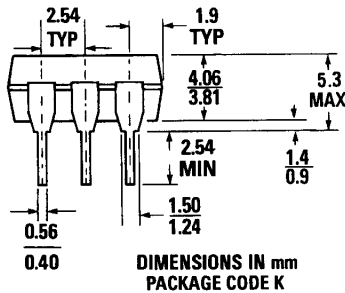

ST1603A

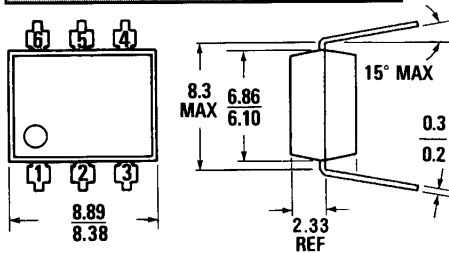
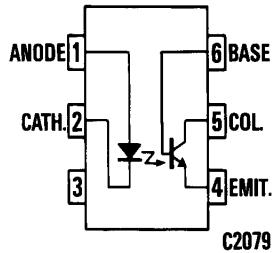

Equivalent Circuit

DESCRIPTION

The H11AG series consists of a gallium-aluminum-arsenide infrared emitting diode coupled with a silicon phototransistor in a dual in-line package. This device provides the unique feature of high current transfer ratio at both low output voltage and low input current. This makes it ideal for use in low power logic circuits, telecommunications equipment and portable electronics isolation applications.

FEATURES

- High efficiency low degradation liquid epitaxial IRED
- Logic level compatible, input and output currents, with CMOS and LS/TTL
- High DC current transfer ratio at low input currents
- Underwriters Laboratory (UL) recognized — File #E90700

APPLICATIONS

- CMOS driven solid state relay
- Telephone ring detector
- Digital logic isolation

ABSOLUTE MAXIMUM RATINGS

TOTAL PACKAGE

Storage temperature -50°C to 150°C
 Operating temperature -50°C to 100°C
 Lead solder temperature 260°C for 10 sec

INPUT DIODE

Power dissipation (25°C ambient) 75 mW
 Derate linearly (above 25°C) 1.0 mW/°C
 Continuous forward current 50 mA
 Reverse voltage 6 V

DETECTOR

Power dissipation (at 25°C ambient) 150 mW
 Derate linearly (above 25°C ambient) 2.0 mW/°C
 V_{CEO} 30 V
 V_{CBO} 70 V
 V_{ECO} 7 V
 Continuous collector current 50 mA



PHOTOTRANSISTOR OPTOCOUPERS

ELECTRICAL CHARACTERISTICS ($T_A=0-70^\circ$ Unless Otherwise Specified)

INDIVIDUAL COMPONENT CHARACTERISTICS

PARAMETER	SYMBOL	MIN.	TYP.	MAX.	UNITS	TEST CONDITIONS
INPUT DIODE						
Forward voltage	V_F			1.5	V	$I_F=1$ mA
Reverse current	I_R			10	μ A	$V_R=5$ V, $T_A=25^\circ$ C
				100	μ A	$V_R=5$ V, $T_A=70^\circ$ C
Capacitance	C_J			100	pF	$V=0$, $f=1$ MHz
OUTPUT DETECTOR						
Breakdown voltage Collector to emitter	BV_{CEO}	30			V	$I_C=1$ mA, $I_F=0$
Breakdown voltage Collector to base	BV_{CBO}	70			V	$I_C=100$ μ A, $I_F=0$
Breakdown voltage Emitter to Collector	BV_{ECO}	7			V	$I_C=100$ μ A, $I_F=0$
Leakage current Collector to emitter	I_{CEO}		5	10	μ A	$V_{CE}=10$ V, $I_F=0$
Capacitance	C_{CE}		2		pF	$V_{CE}=10$ V, $f=1$ MHz

TRANSFER CHARACTERISTICS

CHARACTERISTIC	SYMBOL	MIN.	TYP.	MAX.	UNITS	TEST CONDITIONS
DC current transfer ratio	(H11AG1)	CTR	300		%	$I_F=1$ mA, $V_{CE}=5$ V
	(H11AG2)	CTR	200		%	$I_F=1$ mA, $V_{CE}=5$ V
	(H11AG3)	CTR	100		%	$I_F=1$ mA, $V_{CE}=5$ V
	(H11AG1)	CTR	100		%	$I_F=1$ mA, $V_{CE}=0.6$ V
	(H11AG2)	CTR	50		%	$I_F=1$ mA, $V_{CE}=0.6$ V
	(H11AG3)	CTR	20		%	$I_F=1$ mA, $V_{CE}=0.6$ V
	(H11AG1)	CTR	100		%	$I_F=0.2$ mA, $V_{CE}=1.5$ V
	(H11AG2)	CTR	50		%	$I_F=0.2$ mA, $V_{CE}=1.5$ V
Saturation voltage	$V_{CE(SAT)}$			0.4	V	$I_F=2.0$ mA, $I_C=0.5$ mA
Turn-on time	t_{on}		5		μ S	$V_{CC}=5$ V, $I_F=1$ mA, $R_L=100$ Ω
Turn-off time	t_{off}		5		μ S	$V_{CC}=5$ V, $I_F=1$ mA, $R_L=100$ Ω

ISOLATION CHARACTERISTICS

Surge isolation voltage	V_{ISO}	7500			V_{PEAK}	1 Minute
Surge isolation voltage	V_{ISO}	5300			V_{RMS}	1 Minute

TYPICAL CHARACTERISTICS

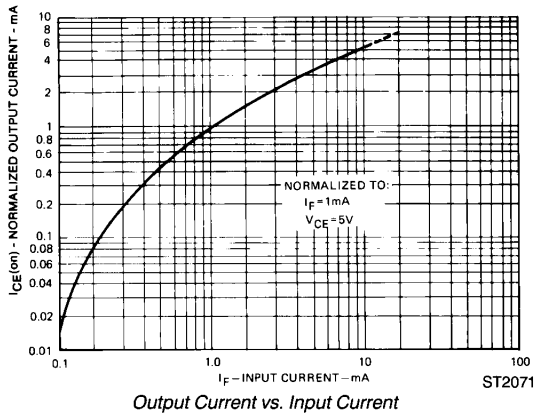

Output Current vs. Input Current

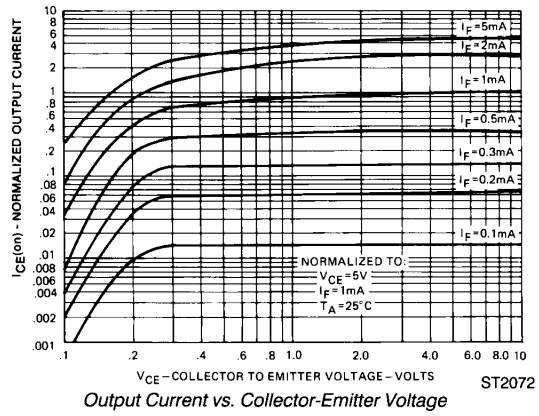

Output Current vs. Collector-Emitter Voltage

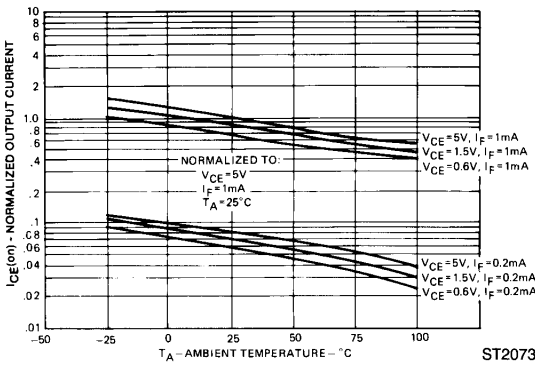

Output Current vs. Temperature

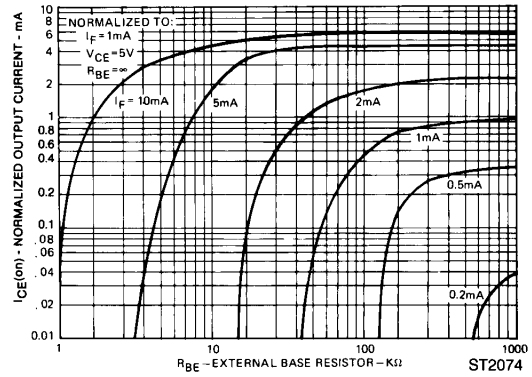

Output Current vs. Base Emitter Resistance

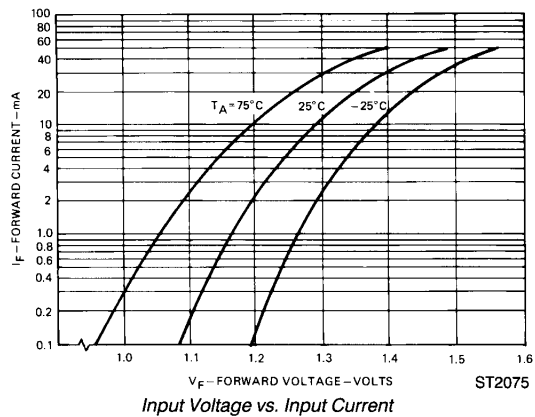

Input Voltage vs. Input Current

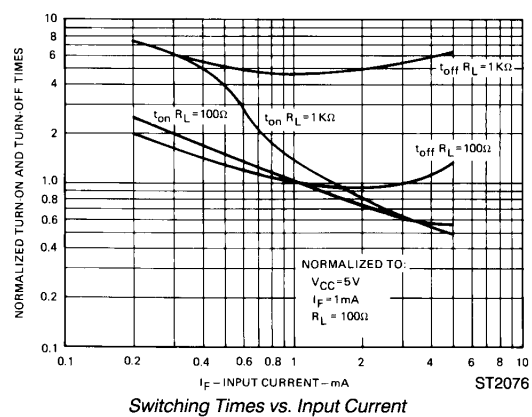

Switching Times vs. Input Current

TYPICAL CHARACTERISTICS

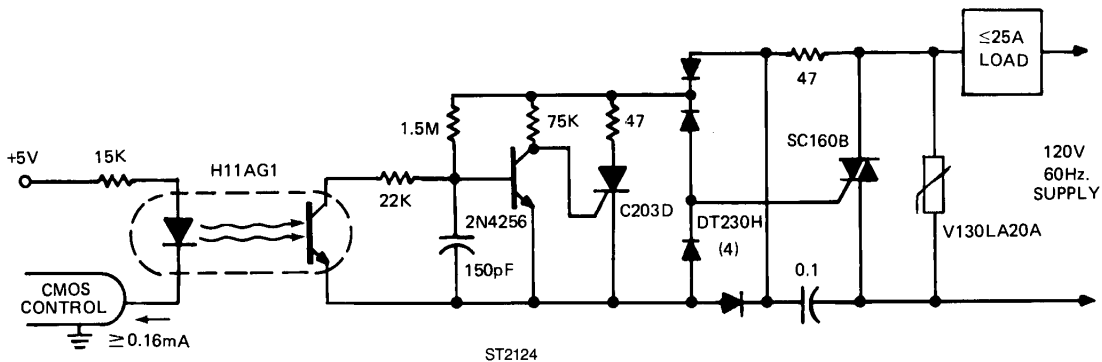
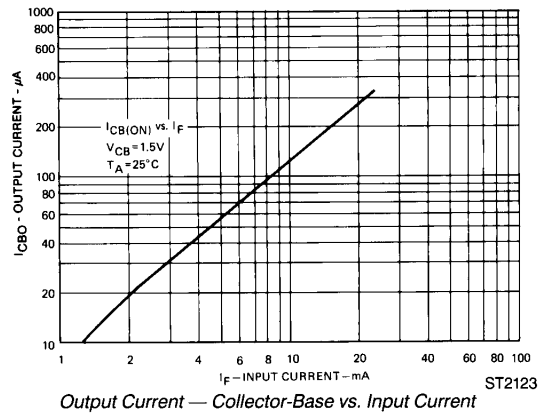
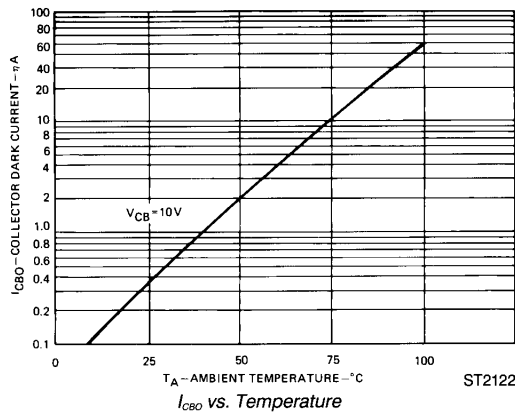

CMOS Input, 3KW, Zero Voltage Switching Solid State Relay

The H11AG1 superior performance at low input currents allows standard CMOS logic circuits to directly operate a 25A solid state relay. Circuit operation is as follows: power switching is provided by the SC160B, 25A triac. Its gate is controlled by the C203B via the DT230H rectifier bridge. The C203B turn-on is inhibited by the 2N4256 when line voltage is above 12V and/or the H11AG1 is off. False trigger and dv/dt protection are provided by the combination of a GE-MOV® varistor and RC snubber network.

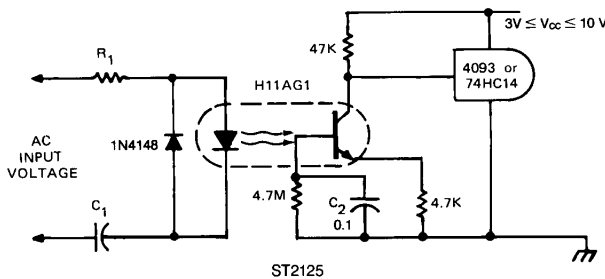

INPUT	R _i	C _i	Z
40-90 VRMS 20 Hz.	75K 1/10 W	0.1 μF 100 V	109K
95-135 VRMS 60 Hz.	180K 1/10 W	12 ηF 200 V	285K
200-280 VRMS 50/60 Hz.	390K 1/4 W	6.80 ηF 400 V	550K

DC component of input voltage is ignored due to C1

TELEPHONE RING DETECTOR/A.C. LINE CMOS INPUT ISOLATOR

The H11AG1 uses less input power than the neon bulb traditionally used to monitor telephone and line voltages. Additionally, response time can be tailored to ignore telephone dial tap, switching transients and other undesired signals by modifying the value of C2. The high impedance to line voltage also can simplify board layout spacing requirements.