



H431 Series

ADJUSTABLE SHUNT REGULATOR

Description

The H431 series are three-terminal adjustable regulators with guaranteed thermal stability over applicable temperature ranges. The output voltage may be set to any value between V_{REF} (approximately 2.495 volts) and 36 volts with two external resistors. These devices have a typical dynamic output impedance of 0.2Ω . Active output circuitry provides a very sharp turn-on characteristic, making these devices excellent replacement for zener diodes in many applications.

Features

- Programmable output voltage
- Temperature coefficient is $50\text{ppm}/^\circ\text{C}$ typical
- Temperature compensated for operation over full temperature range
- Low output noise voltage
- Fast turn on response

Ordering Information

Package	$V_{REF}: 2.495\pm 2\%$	$V_{REF}: 2.495\pm 1\%$	$V_{REF}: 2.495\pm 0.5\%$
SOT-23	H431AN	H431BN	H431CN
SOT-89	H431AM	H431BM	H431CM
TO-92	H431AA	H431BA	H431CA
SO-8	H431AS	H431BS	H431CS

Absolute Maximum Ratings

(Operating temperature range applies unless otherwise specified)

Characteristics	Symbol	Value	Unit
Cathode Voltage	V_{KA}	36	V
Cathode Current Range (Continuous)	I_K	-100~+150	mA
Reference Input Current Range	I_{REF}	0.05~+10	mA
Power Dissipation	P_D	SOT-23	280
		SOT-89	770
		TO-92	770
		SO-8	770
Operating Temperature Range	T_{opr}	-40~+125	$^\circ\text{C}$
Storage Temperature Range	T_{stg}	-65~+150	$^\circ\text{C}$

Operating Conditions

Characteristics	Symbol	Min.	Max.	Unit
Cathode Voltage	V_{KA}	V_{REF}	36	V
Cathode Current Range (Continuous)	I_K	1	100	mA

H431 Series Pin Assignment



3-Lead Plastic **SOT-23**
 Package Code: N
 Pin 1: Reference
 Pin 2: Cathode
 Pin 3: Anode

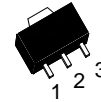

3-Lead Plastic **SOT-89**
 Package Code: M
 Pin 1: Reference
 Pin 2: Anode
 Pin 3: Cathode

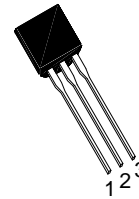

3-Lead Plastic **TO-92**
 Package Code: A
 Pin 1: Reference
 Pin 2: Anode
 Pin 3: Cathode

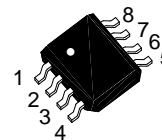

3-Lead Plastic **SO-8**
 Package Code: S
 Pin 1: Cathode
 Pin 2/3/6/7: Anode
 Pin 4/5: NC
 Pin 8: Reference



Functional Block Diagram & Symbol

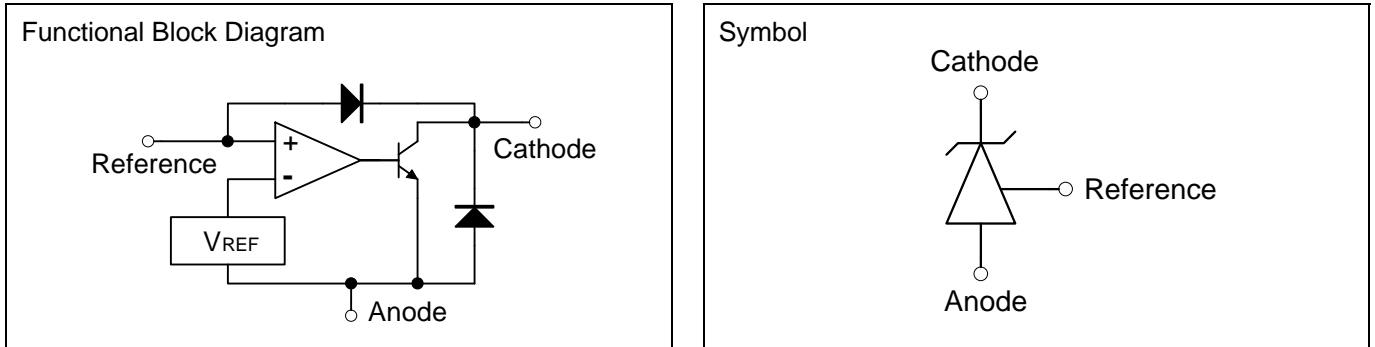

Test Circuits

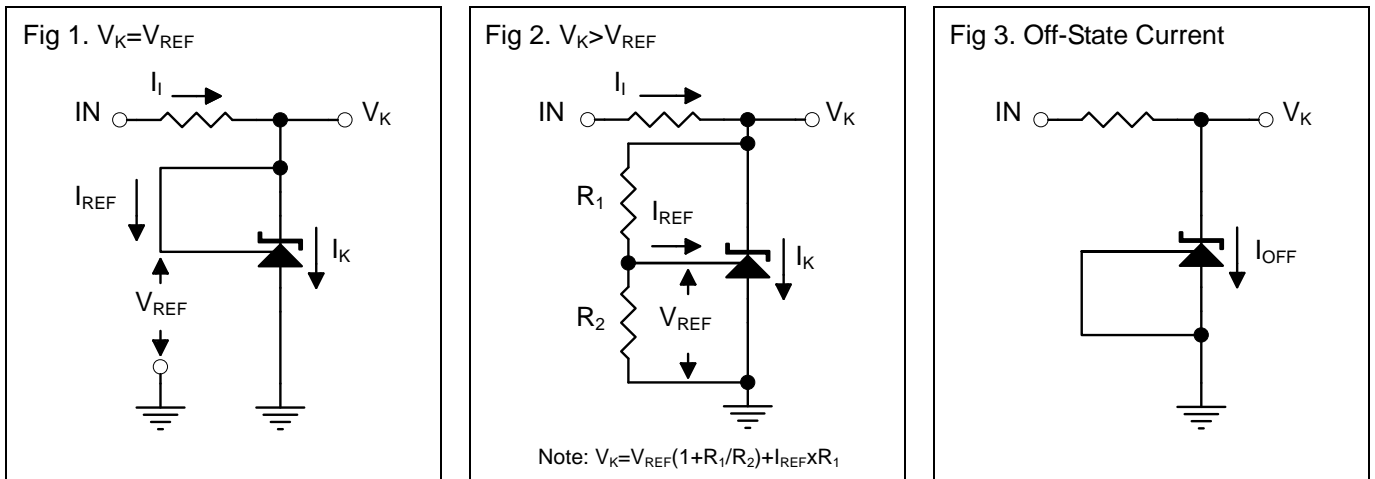

Electrical Characteristics ($T_A = 25^\circ\text{C}$ unless otherwise specified)

Characteristics		Symbol	Test Conditions	Min	Typ	Max	Unit
Reference Input Voltage ^(Fig1)	H431AN/AM/AA/AS	V_{REF}	$V_K = V_{REF}, I_K = 10\text{mA}$	2.445	2.495	2.545	V
	H431BN/BM/BA/BS			2.470	2.495	2.520	
	H431CN/CM/CA/CS			2.483	2.495	2.507	
Deviation of Reference Input Voltage Over-Temperature ^(Fig1)		$V_{REF(\text{dev})}$	$V_K = V_{REF}, I_K = 10\text{mA}$ $T_{\text{min}} \leq T_a \leq T_{\text{max}}$	-	4	17	mV
Ratio of Change in Reference Input Voltage to the Change in Cathode Voltage ^(Fig2)		$\Delta V_{REF} / \Delta V_K$	$I_K = 10\text{mA},$ $\Delta V_K = 10\text{V to } V_{REF}$	-	-1.4	-2.7	mV/V
			$I_K = 10\text{mA},$ $\Delta V_K = 36\text{V to } 10\text{V}$	-	-1.0	-2.0	mV/V
Reference Input Current ^(Fig2)		I_{REF}	$I_K = 10\text{mA}, R_1 = 10\text{k}\Omega,$ $R_2 = \infty$	-	2	4	μA
Deviation of Reference Input Current Over Full Temperature Range ^(Fig2)		$I_{REF(\text{dev})}$	$I_K = 10\text{mA}, R_1 = 10\text{k}\Omega,$ $R_2 = \infty, T_a = \text{Full Range}$	-	0.4	1.2	μA
Minimum Cathode Current for Regulation ^(Fig1)		$I_{K(\text{min})}$	$V_K = V_{REF}$	-	0.4	1.0	mA
Off-State Cathode Current ^(Fig3)		$I_{K(\text{off})}$	$V_K = 36\text{V}, V_{REF} = 0$	-	0.1	1.0	μA
Dynamic Output Impedance ^(Fig1)		Z_K	$V_K = V_{REF}, f \leq 1\text{kHz}$ $I_K = 1 \text{ to } 100\text{mA}$	-	0.2	0.5	Ω



Characteristics Curve

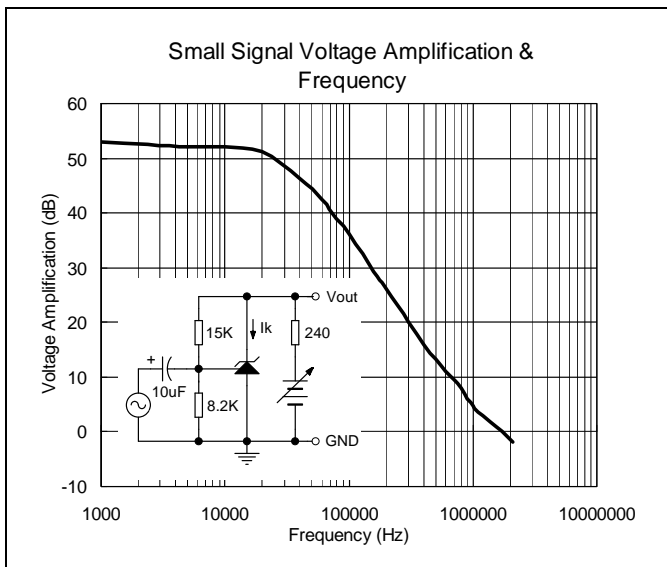
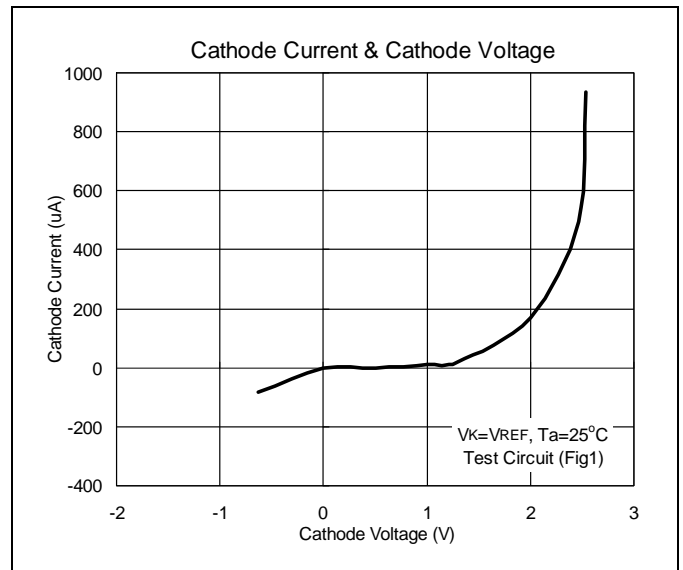
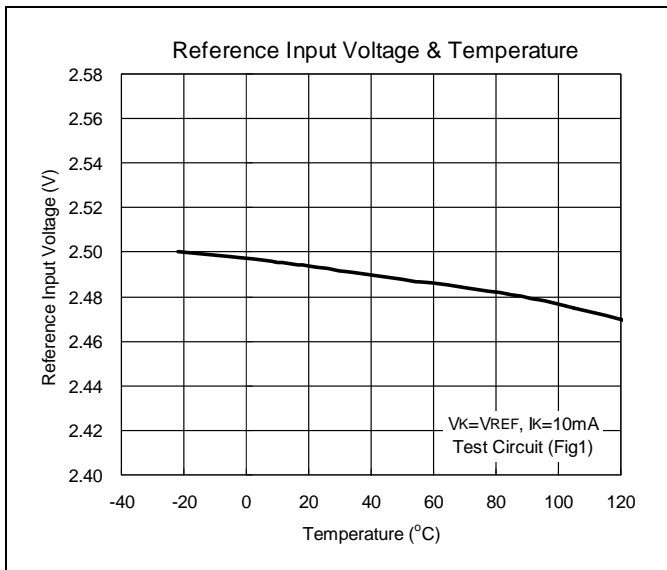
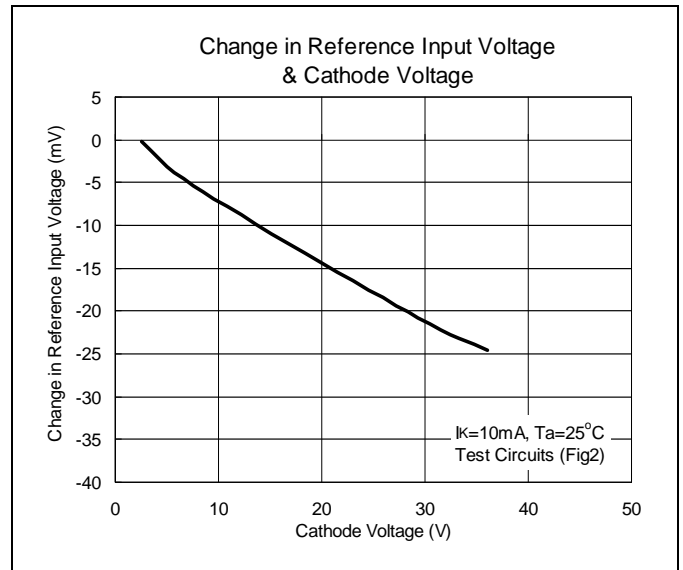
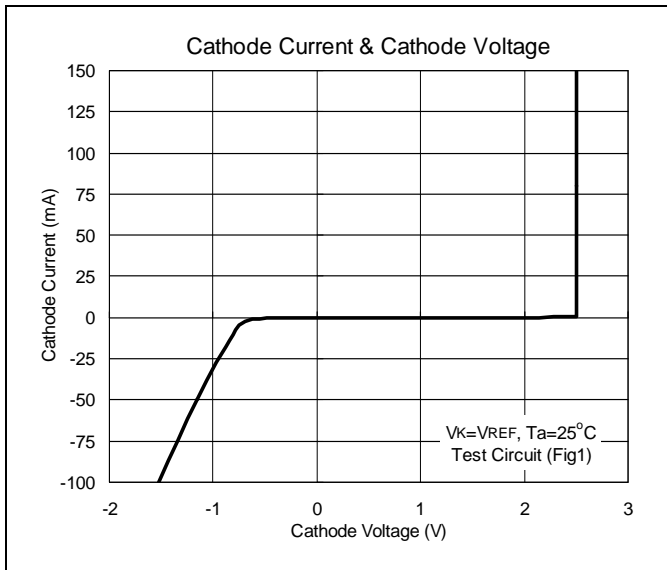



Typical Application

Fig 4. Shunt Regulator

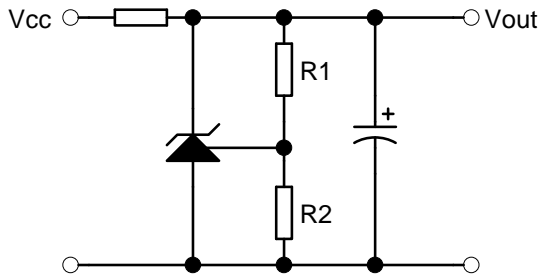

$$V_{out} = (1 + R_1/R_2)V_{REF}$$

Fig 5. High Current Shunt Regulator

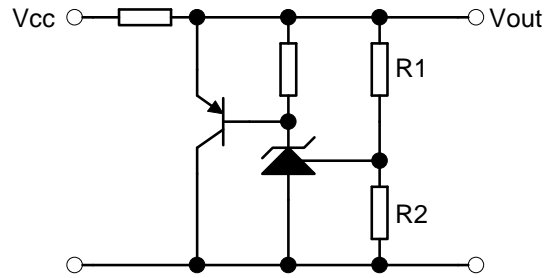

$$V_{out} = (1 + R_1/R_2)V_{REF}$$

Fig 6. Output Control of a Three-Terminal Fixed Regulator

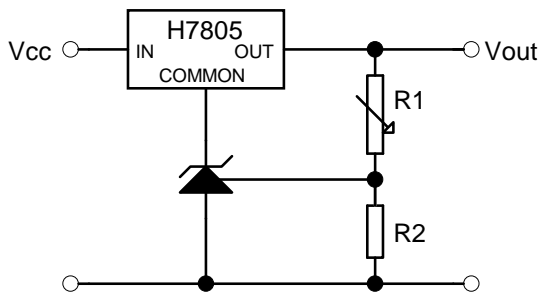

$$V_{out} = (1 + R_1/R_2)V_{REF}; V_{out(min)} = V_{REF} + 5V$$

Fig 7. Series Pass Regulator

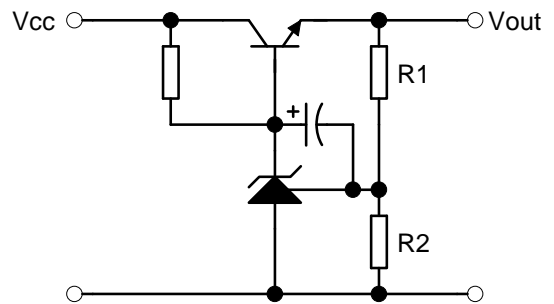

$$V_{out} = (1 + R_1/R_2)V_{REF}; V_{out(min)} = V_{REF} + V_{BE}$$

Fig 8. Current Limiter or Current Source

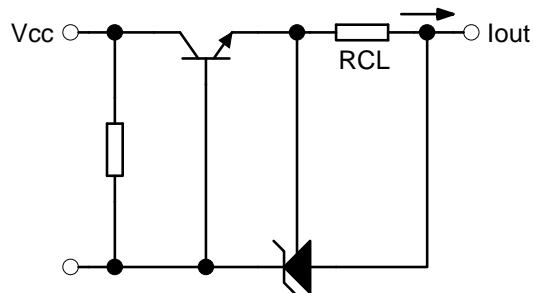

$$I_{out} = V_{REF}/R_{CL}$$

Fig 9. Constant Current Sink

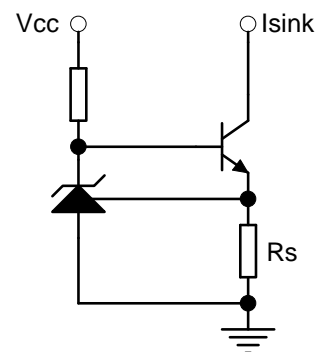

$$I_{sink} = V_{REF}/R_s$$



SOT-23 Dimension

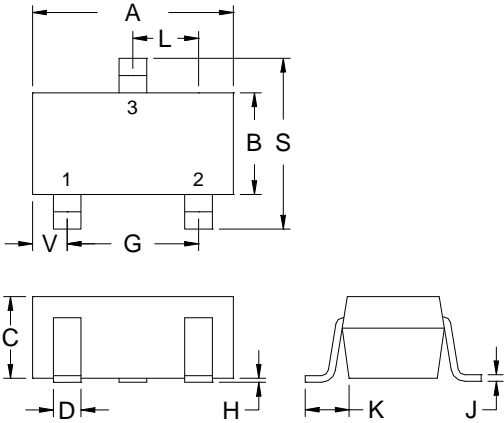

3-Lead SOT-23 Plastic Surface Mounted Package
HSMC Package Code: N

Marking:

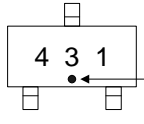

Pb Free Mark
 Pb-Free: "●" (Note)
 Normal: None

Note: Pb-free product can distinguish by the green label or the extra description on the right side of the label.

Pin Style: 1.Reference 2.Cathode 3.Anode

Material:

- Lead solder plating: Sn60/Pb40 (Normal), Sn/3.0Ag/0.5Cu or Pure-Tin (Pb-free)
- Mold Compound: Epoxy resin family, flammability solid burning class: UL94V-0

DIM	Min.	Max.
A	2.80	3.04
B	1.20	1.60
C	0.89	1.30
D	0.30	0.50
G	1.70	2.30
H	0.013	0.10
J	0.085	0.177
K	0.32	0.67
L	0.85	1.15
S	2.10	2.75
V	0.25	0.65

*: Typical, Unit: mm

SOT-89 Dimension

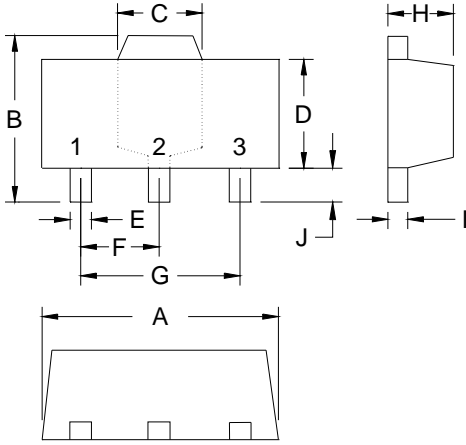

3-Lead SOT-89 Plastic Surface Mounted Package
HSMC Package Code: M

Marking:

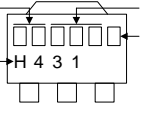

Date Code
 Control Code
 HSMC Logo
 Pb Free Mark
 Pb-Free: "●" (Note)
 Normal: None

Note: Green label is used for pb-free packing

Pin Style: 1.Reference 2.Anode 3.Cathode

Material:

- Lead solder plating: Sn60/Pb40 (Normal), Sn/3.0Ag/0.5Cu or Pure-Tin (Pb-free)
- Mold Compound: Epoxy resin family, flammability solid burning class: UL94V-0

DIM	Min.	Max.
A	4.40	4.60
B	4.05	4.25
C	1.50	1.70
D	2.40	2.60
E	0.36	0.51
F	*1.50	-
G	*3.00	-
H	1.40	1.60
I	0.35	0.41

*: Typical, Unit: mm



TO-92 Dimension

3-Lead TO-92 Plastic Package
HSMC Package Code: A

Marking:

Pb Free Mark
 Pb-Free: "●" (Note)
 Normal: None

Date Code Control Code

Note: Green label is used for pb-free packing
 Pin Style: 1.Reference 2.Anode 3.Cathode

Material:
 • Lead solder plating: Sn60/Pb40 (Normal), Sn/3.0Ag/0.5Cu or Pure-Tin (Pb-free)
 • Mold Compound: Epoxy resin family, flammability solid burning class: UL94V-0

DIM	Min.	Max.
A	4.33	4.83
B	4.33	4.83
C	12.70	-
D	0.36	0.56
E	-	*1.27
F	3.36	3.76
G	0.36	0.56
H	-	*2.54
I	-	*1.27
$\alpha 1$	-	*5°
$\alpha 2$	-	*2°
$\alpha 3$	-	*2°

*: Typical, Unit: mm

SO-8 Dimension

8-Lead SO-8 Plastic Surface Mounted Package
HSMC Package Code: S

Marking:

Pb Free Mark
 Pb-Free: "●" (Note)
 Normal: None

Pin 1 Mark
 Date Code Control Code

Note: Green label is used for pb-free packing
 Pin Style: 1.Cathode 2/3/6/7.Anode 4/5.NC 8.Reference

Material:
 • Lead solder plating: Sn60/Pb40 (Normal), Sn/3.0Ag/0.5Cu or Pure-Tin (Pb-free)
 • Mold Compound: Epoxy resin family, flammability solid burning class: UL94V-0

DIM	Min.	Max.
A	4.85	5.10
B	3.85	3.95
C	5.80	6.20
D	1.22	1.32
E	0.37	0.47
F	3.74	3.88
G	1.45	1.65
H	4.80	5.10
I	0.05	0.20
J	0.30	0.70
K	0.19	0.25
L	0.37	0.52
M	0.23	0.28
N	0.08	0.13
O	0.00	0.15

*: Typical, Unit: mm

Important Notice:

- All rights are reserved. Reproduction in whole or in part is prohibited without the prior written approval of HSMC.
- HSMC reserves the right to make changes to its products without notice.
- **HSMC semiconductor products are not warranted to be suitable for use in Life-Support Applications, or systems.**
- HSMC assumes no liability for any consequence of customer product design, infringement of patents, or application assistance.

Head Office And Factory:

- **Head Office** (Hi-Sincerity Microelectronics Corp.): 10F.,No. 61, Sec. 2, Chung-Shan N. Rd. Taipei Taiwan R.O.C.
 Tel: 886-2-25212056 Fax: 886-2-25632712, 25368454
- **Factory 1:** No. 38, Kuang Fu S. Rd., Fu-Kou Hsin-Chu Industrial Park Hsin-Chu Taiwan. R.O.C
 Tel: 886-3-5983621~5 Fax: 886-3-5982931



Soldering Methods for HSMC's Products

1. Storage environment: Temperature=10°C~35°C Humidity=65%±15%
2. Reflow soldering of surface-mount devices

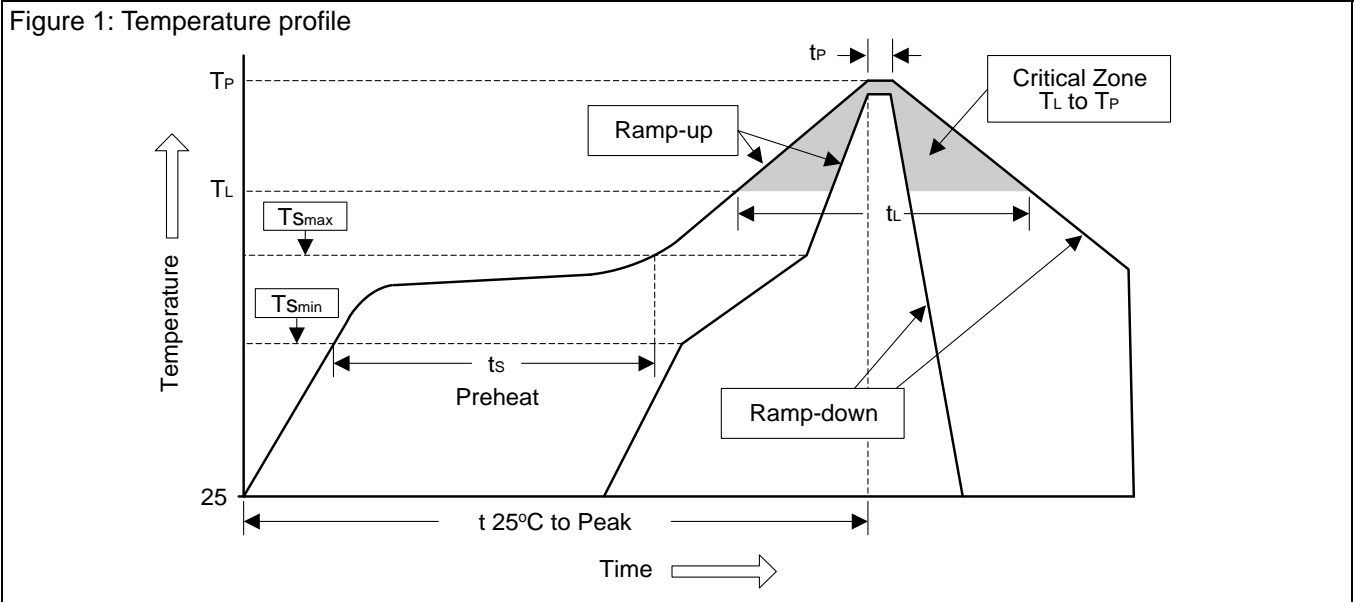

Profile Feature	Sn-Pb Eutectic Assembly	Pb-Free Assembly
Average ramp-up rate (T_L to T_P)	$< 3^{\circ}\text{C/sec}$	$< 3^{\circ}\text{C/sec}$
Preheat		
- Temperature Min (T_{Smin})	100°C	150°C
- Temperature Max (T_{Smax})	150°C	200°C
- Time (min to max) (t_s)	60~120 sec	60~180 sec
T_{Smax} to T_L		
- Ramp-up Rate	$< 3^{\circ}\text{C/sec}$	$< 3^{\circ}\text{C/sec}$
Time maintained above:		
- Temperature (T_L)	183°C	217°C
- Time (t_L)	60~150 sec	60~150 sec
Peak Temperature (T_P)	240°C +0/-5°C	260°C +0/-5°C
Time within 5°C of actual Peak Temperature (t_P)	10~30 sec	20~40 sec
Ramp-down Rate	$< 6^{\circ}\text{C/sec}$	$< 6^{\circ}\text{C/sec}$
Time 25°C to Peak Temperature	< 6 minutes	< 8 minutes

3. Flow (wave) soldering (solder dipping)

Products	Peak temperature	Dipping time
Pb devices.	245°C ±5°C	10sec ±1sec
Pb-Free devices.	260°C ±5°C	10sec ±1sec