HA12216F/HA12221F Series

Audio Signal Processor for Car Deck
(Decode only Dolby B type NR with PB Amp.)

REJ03F0132-0600
(Previous: ADE-207-254E)
Rev.6.00
Jun 15, 2005

Description

HA12216F/HA12221F series are silicon monolithic bipolar IC providing Dolby B type noise reduction, music sensor, PB equalizer system in one chip.

- Notes: 1. Dolby is a trademark of Dolby Laboratories Licensing Corporation.
A license from Dolby Laboratories Licensing Corporation is required for the use of this IC.
2. HA12221F series does not include Dolby B NR.

Functions

- PB equalizer × 2 channel
- Music sensor × 1 channel
- Dolby B NR (Only HA12216F series) × 2 channel
- Line mute (Tape radio) SW × 2 channel

Features

- Different type of PB equalizer characteristics selection (120 μ s/70 μ s) is available with fully electronic control switching built-in.
- Changeable to Forward, Reverse-mode for PB head with fully electronic control switching built-in.
- Available to change music sensing level by external resistor.
- Available to change response of music sensor by external capacitor.
- Music sensing level, built-in switch to change a band (MSG_V).
- NR ON/OFF fully electronic control switching built-in. (Only HA12216F series)
- Line mute (Tape radio) control switching built-in.
- Available to connect direct with MPU.
- These ICs are strong for a cellular phone noise. (18 dB improvement from HA12163)

Ordering Information

Operating Voltage

Product	Min	Max	Unit
HA12216F/HA12221F	6.5	12	V
HA12217F/HA12222F	6.8	12	V
HA12218F/HA12223F	7.2	12	V

Notes: 1. These ICs are designed to operate on single supply.

2. HA12217F and HA12218F, HA12222F and HA12223F are develop, there meets comply with your demands.

Standard Level

Product	Package Code (Previous Code)	PB-OUT Level
HA12216F/HA12221F	PLQP0040JB-A (FP-40B)	300 mVrms
HA12217F/HA12222F	PLQP0040JB-A (FP-40B)	387.5 mVrms
HA12218F/HA12223F	PLQP0040JB-A (FP-40B)	450 mVrms

Function

Product	PB-EQ	Music Sensor	Mute	Dolby B NR
HA12216F series	○	○	○	○
HA12221F series	○	○	○	×

Parallel-Data Format

Pin No.	Pin Name	Lo	Hi
10	TAPE/RADIO	TAPE	RADIO
11*	NR ON/OFF	NR OFF	NR ON
12	120 μ /70 μ	120 μ (Normal)	70 μ (Metal or Chrome)
13	Forward/Reverse	Forward	Reverse
14	Search/Repeat	Search (FF or REV)	Repeat (Normal Speed)

Note: Non connection regarding HA12221F series.

Pin Description, Equivalent Circuit

($V_{CC} = 9\text{ V}$, A system of single supply voltage, $T_a = 25^\circ\text{C}$, No Signal, The value in the show typical value.)

Pin No.	Terminal Name	Note	Equivalent Circuit	Pin Description
18	MSI	$V = V_{CC}/2$		MS input *1
28	TAI (L)			Tape input
3	TAI (R)			Radio input (Mute)
26	RAI (L)			
5	RAI (R)			
23 *2	DET (L)	$V = 2.5\text{V}$		Time constant pin for rectifier
8 *2	DET (R)			Ripple filter
33	RIP			$V = V_{CC}/2$
4 *2	Bias	$V = 0.28\text{V}$		Dolby bias current input
17	MSDET	—		Time constant pin for rectifier

- Notes: 1. MS: Music Sensor
 2. Non connection regarding HA12221F series.

Pin Description, Equivalent Circuit (cont.)

($V_{CC} = 9\text{ V}$, A system of single supply voltage, $T_a = 25^\circ\text{C}$, No Signal, The value in the show typical value.)

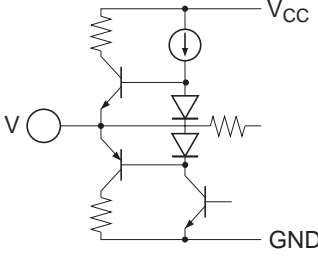
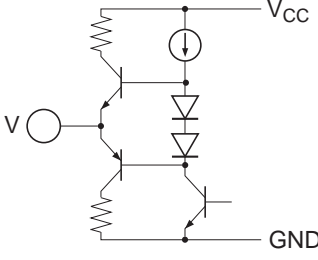
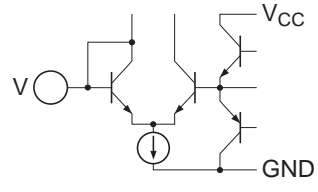
Pin No.	Terminal Name	Note	Equivalent Circuit	Pin Description
25	PBOUT (L)	$V = V_{CC}/2$		PB output
6	PBOUT (R)			
19	MAOUT	$V = V_{CC}/2$		MS amp. output * ¹
38	VREF			Reference output
29	EQOUT (L)			Equalizer output (120μ)
2	EQOUT (R)			
30	M-OUT (L)	$V = V_{CC}/2$		Equalizer output (70μ)
1	M-OUT (R)			
16	V_{CC}	—		Power supply
7	NC	—		No connection
9				
22				
24				
27				

Note: 1. MS: Music Sensor

Pin Description, Equivalent Circuit (cont.)

(V_{CC} = 9 V, A system of single supply voltage, Ta = 25°C, No Signal, The value in the show typical value.)

Pin No.	Terminal Name	Note	Equivalent Circuit	Pin Description
34	FIN (L)	—		Equalizer input (Forward)
37	FIN (R)			Equalizer input (Reverse)
32	RIN (L)			Negative feedback
39	RIN (R)			
31	NFI (L)			
40	NFI (R)			
10	T/R (Mute)	—		Mode control input
11 * ²	NR ON/OFF			
12	120/70			
13	F/R			
14	S/R (MS G _v)			
15	MSOUT	—		
20	MS G _v (R)	V = V _{CC} /2		MS gain terminal * ¹
21	MS G _v (S)			
35	GND	—		GND pin
36				

- Notes: 1. MS: Music Sensor
 2. Non connection regarding HA12221F series.

Block Diagram

HA12216F Series

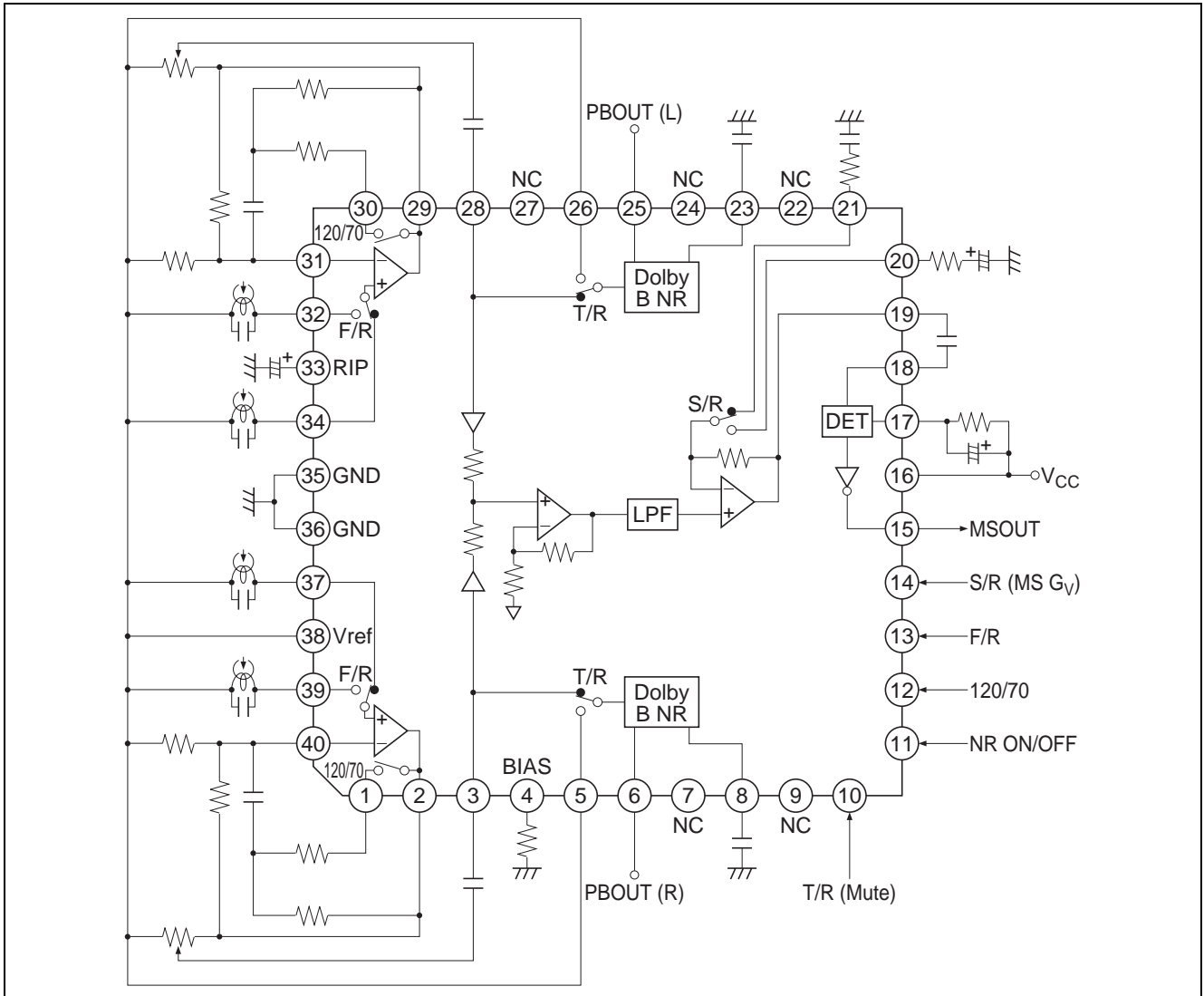

HA12221F Series

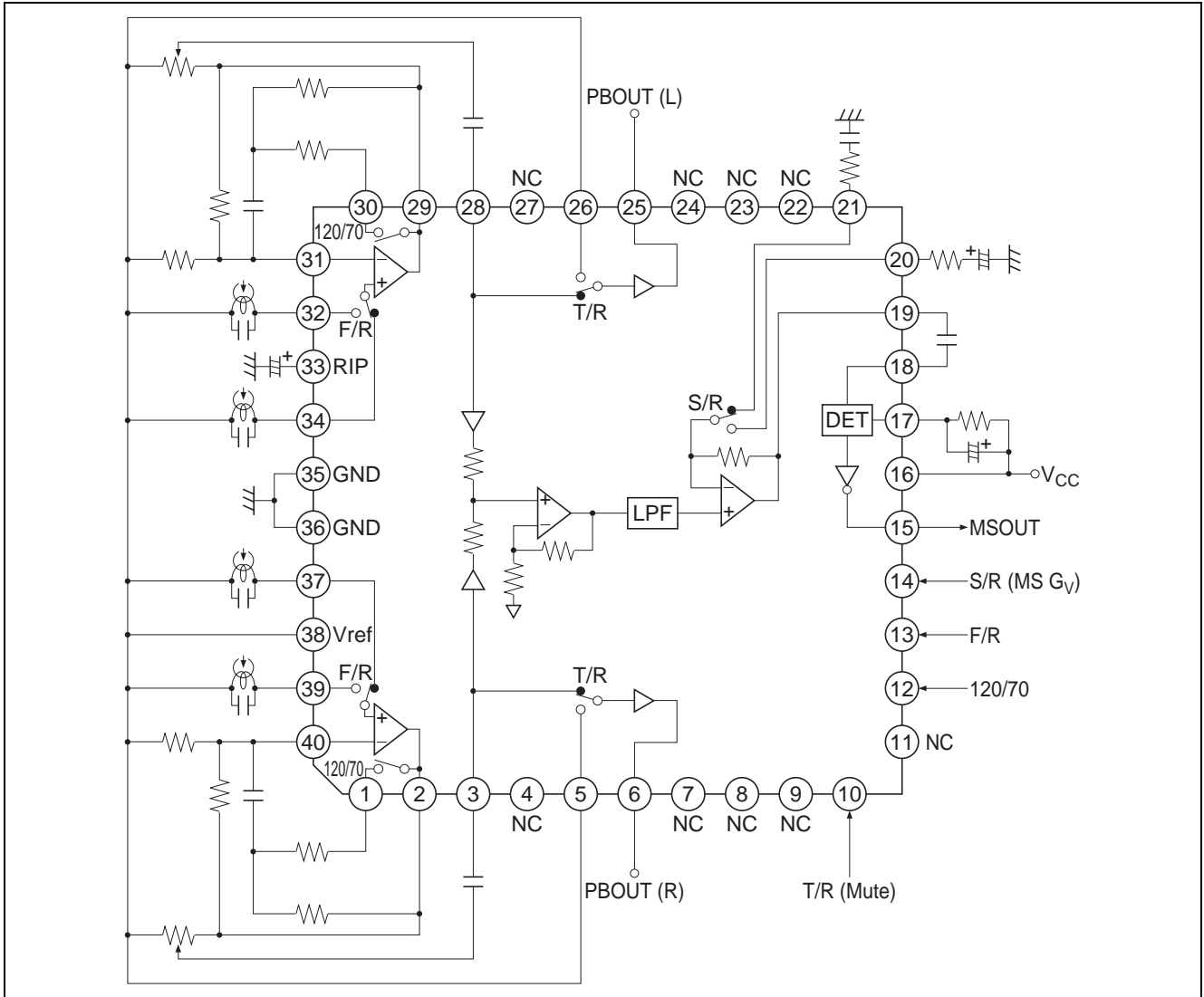

Functional Description

Power Supply Range

HA12216F/HA12221F series are provided with three line output level, which will permit on optimum overload margin for power supply conditions. And these are designed to operate on single supply only.

Table 1 Supply Voltage Range

Product	Single Supply
HA12216F/HA12221F	6.5 V to 12.0 V
HA12217F/HA12222F	6.8 V to 12.0 V
HA12218F/HA12223F	7.2 V to 12.0 V

Note: The lower limit of supply voltage depends on the line output reference level.
The minimum value of the overload margin is specified as 12 dB by Dolby Laboratories.

Reference Voltage

These devices provide the reference voltage of half the supply voltage that is the signal grounds. As the peculiarity of these devices, the capacitor for the ripple filter is very small about 1/100 compared with their usual value. The block diagram is shown as figure 1.

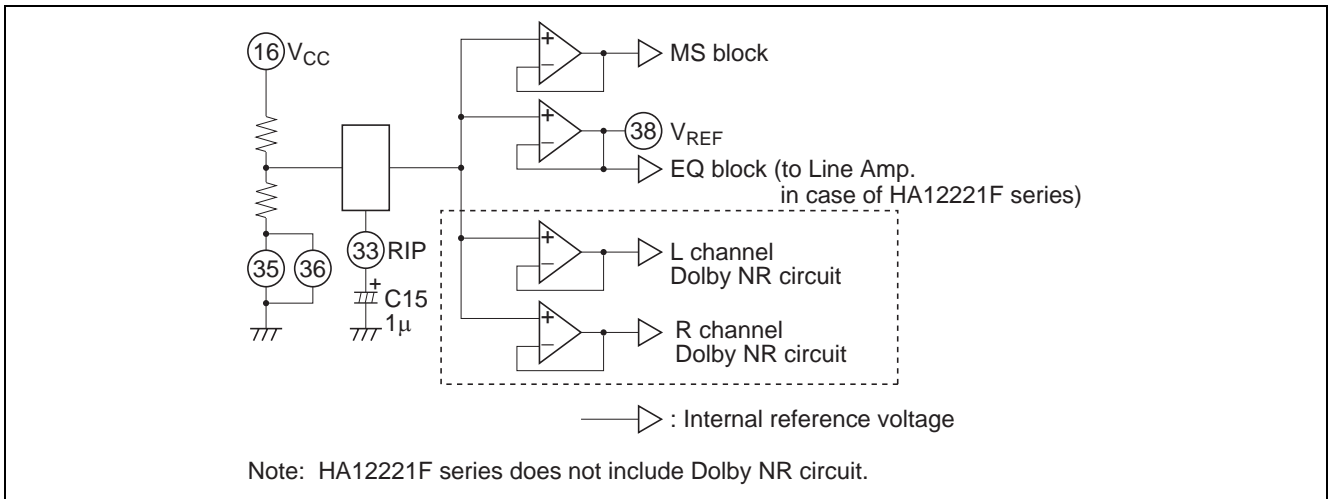

Figure 1 The Block Diagram of Reference Supply Voltage

Operating Mode Control

HA12216F/HA12221F series provides fully electronic switching circuits. And each operating mode control are controlled by parallel data (DC voltage).

When a power supply of this IC is cut off, for a voltage, in addition to a mode control terminal even though as do not destruct it, in series for resistance.

Table 2 Threshold Voltage (V_{TH})

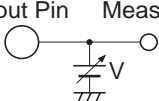
Pin No.	Lo	Hi	Unit	Test Condition
10, 11*, 12, 13, 14	-0.2 to 1.0	3.5 to V_{CC}	V	Input Pin Measure 

Note: * Non connection regarding HA12221F series.

Table 3 Switching Truth Table

Pin No.	Lo	Hi
10	TAPE	RADIO
11*	NR OFF	NR ON
12	120 μ (Normal)	70 μ (Metal or Chrome)
13	FORWARD	REVERSE
14	SER (FF or REV)	REP (Normal Speed)

Notes: * Non connection regarding HA12221F series.

1. Each pins are on pulled down with 100 k Ω internal resistor. Therefore, it will be low-level when each pins are open.
2. Over shoot level and under shoot level of input signal must be the standardized. (High: V_{CC} , Low: -0.2 V)
3. Reducing pop noise is so much better for 10 k Ω to 22 k Ω resisitor and 1 μ F to 22 μ F capacitor shown figure 2.

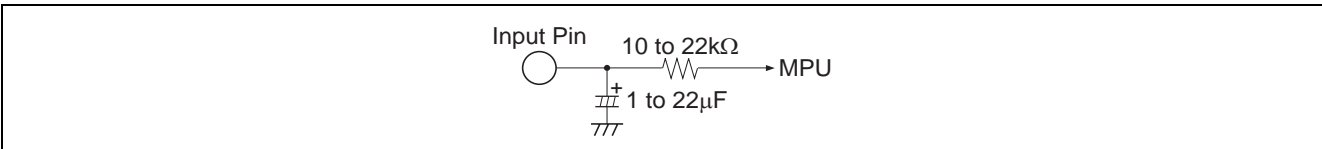

Figure 2 Interface for Reduction of Pop Noise

Input Block Diagram and Level Diagram

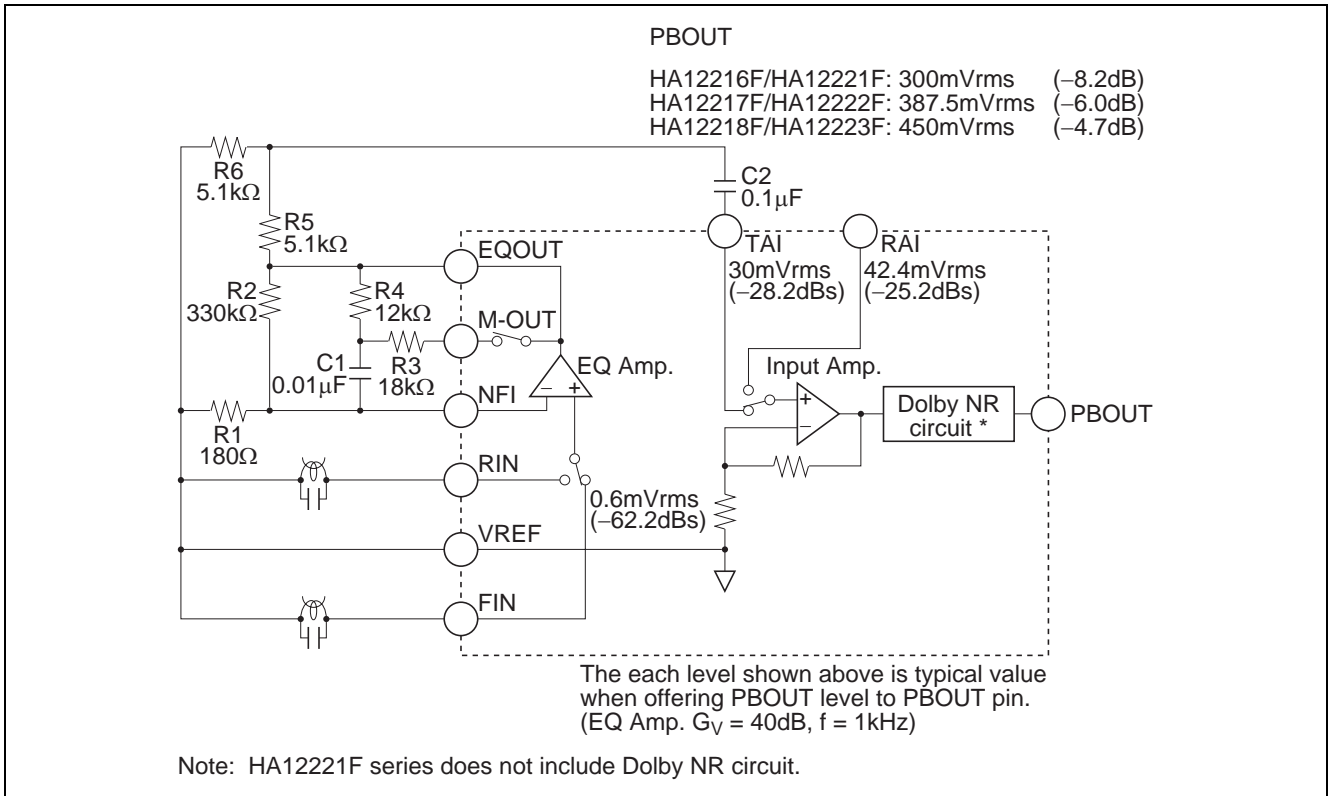

Figure 3 Input Block Diagram

Adjustment of Playback Reference Operate Level

After replace R5 and R6 with a half-fix volume of 10 kΩ, adjust playback reference operate level.

The Sensitivity Adjustment of Music Sensor

Adjusting MS Amp. gain by external resistor, the sensitivity of music sensor can set up. The music sensor block diagram is shown in figure 4, and frequency response is shown in figure 5.

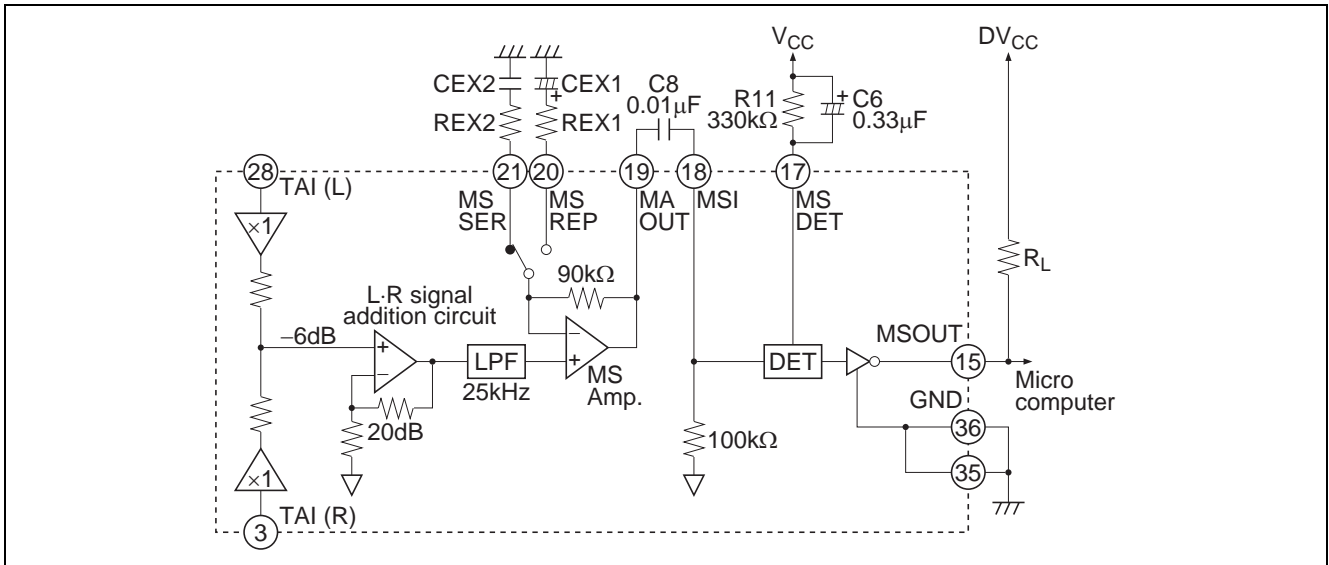

Figure 4 Music Sensor Block Diagram

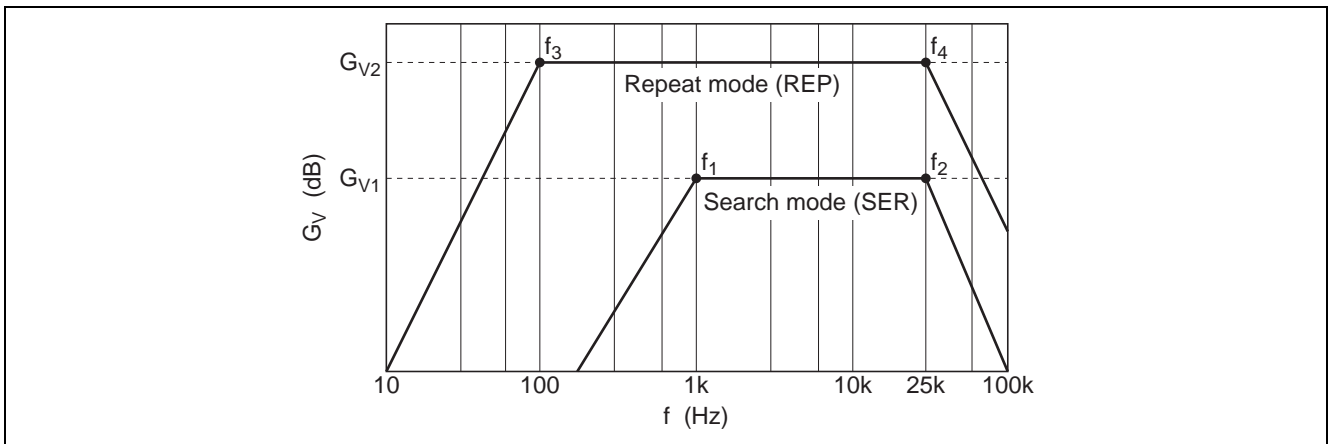

Figure 5 Frequency Response

1. Search mode

$$G_{V1} = 20\text{dB} + 20\log\left(1 + \frac{90\text{k}}{\text{REX2}}\right) \text{ [dB]}$$

$$f_1 = \frac{1}{2\pi \cdot \text{CEX2} \cdot \text{REX2}} \text{ [Hz]}, f_2 = 25\text{k} \text{ [Hz]}$$

2. Repeat mode

$$G_{V2} = 20\text{dB} + 20\log\left(1 + \frac{90\text{k}}{\text{REX1}}\right) \text{ [dB]}$$

$$f_3 = \frac{1}{2\pi \cdot \text{CEX1} \cdot \text{REX1}} \text{ [Hz]}, f_4 = 25\text{k} \text{ [Hz]}$$

G_{VIA} : L-R signal addition circuit gain.

The sensitivity of music sensor (S) is computed by the formula mentioned below.

$$S = -\left(G_V^{*1} - 20\log\frac{130^{*3}}{30^{*2}}\right) = 12.7 - G_V \text{ [dB]}$$

- Note:
1. Search mode: G_{V1} , Repeat mode: G_{V2}
 2. Standard level of TAI pin (Dolby level correspondence) = 30 mVrms
 3. Standard sensing level of music sensor = 130 mVrms

Item	REX1, 2	CEX1, 2	$G_{V1, 2}$	$f_{1, 3}$	$f_{2, 4}$	S (one side channel)	S (both channel)
Search mode	24 kΩ	0.01 μF	33.5 dB	663 Hz	25 kHz	-14.8 dB	-20.8 dB
Repeat mode	2.4 kΩ	1 μF	51.7 dB	66.3 Hz	25 kHz	-33.0 dB	-39.0 dB

Note: S is 6 dB down in case of one-side channel. And this MS presented hysteresis lest MSOUT terminal should turn over again Hi level or Lo level, in case of thresh S level constantly.

Music Sensor Time Constant

1. Sensing no signal to signal (Attack) is determined by C6, 0.01 μF to 1 μF capacitor C6 can be applicable.
2. Sensing signal to no signal (Recovery) is determined by C6 and R11, however preceding (1), 100 kΩ to 1 MΩ can be applicable.

Music Sensor Output (MSOUT)

As for the internal circuit of music sensor block, music sensor output pin is connected to the collector of NPN type directly, therefore, output level will be “high” when sensing no signal. And output level will be “low” when sensing signal.

$$I_L = \frac{DV_{CC} - \text{MSOUT}_{LO}^*}{R_L}$$

* MSOUT_{LO} : Sensing signal (about 1V)

Note: 1. Supply voltage of MSOUT pin must be less than V_{CC} voltage.

The Tolerances of External Components for Dolby NR (Only HA12216F Series)

For adequate Dolby NR tracking response, take external components shown below.
Also, leak is small capacity, and please employ a good quality object.

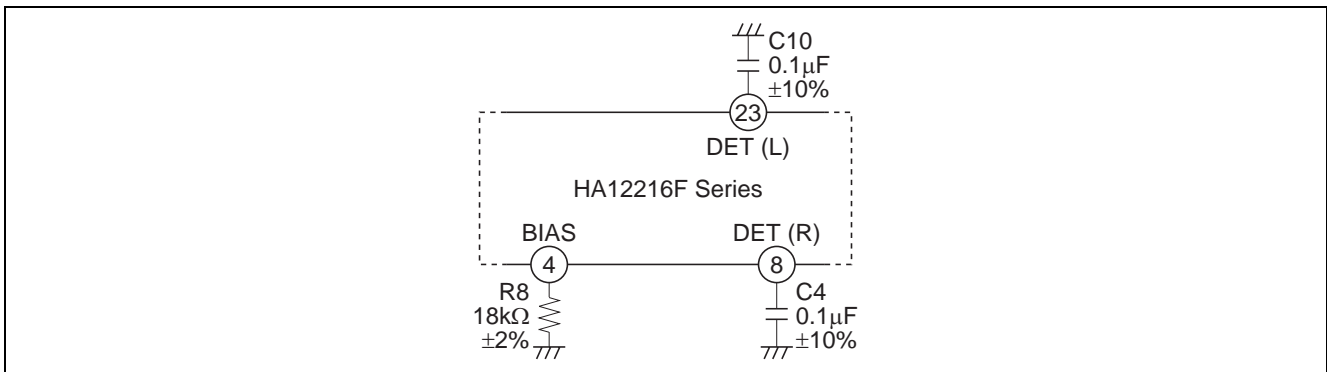

Figure 6 Tolerance of External Components

Countermeasure of a Cellular Phone Noise

This IC have reinforced a cellular phone noise countermeasure, to show it hereinafter.
However, it is presumed that this effect change it greatly, by a mount set.
Please sufficiently examine an arrangement of positions, shield method, wiring pattern, in order to obtain a maximum effect.
A high terminal of a noise sensitivity of this IC is FIN, RIN, NFI and RIP.

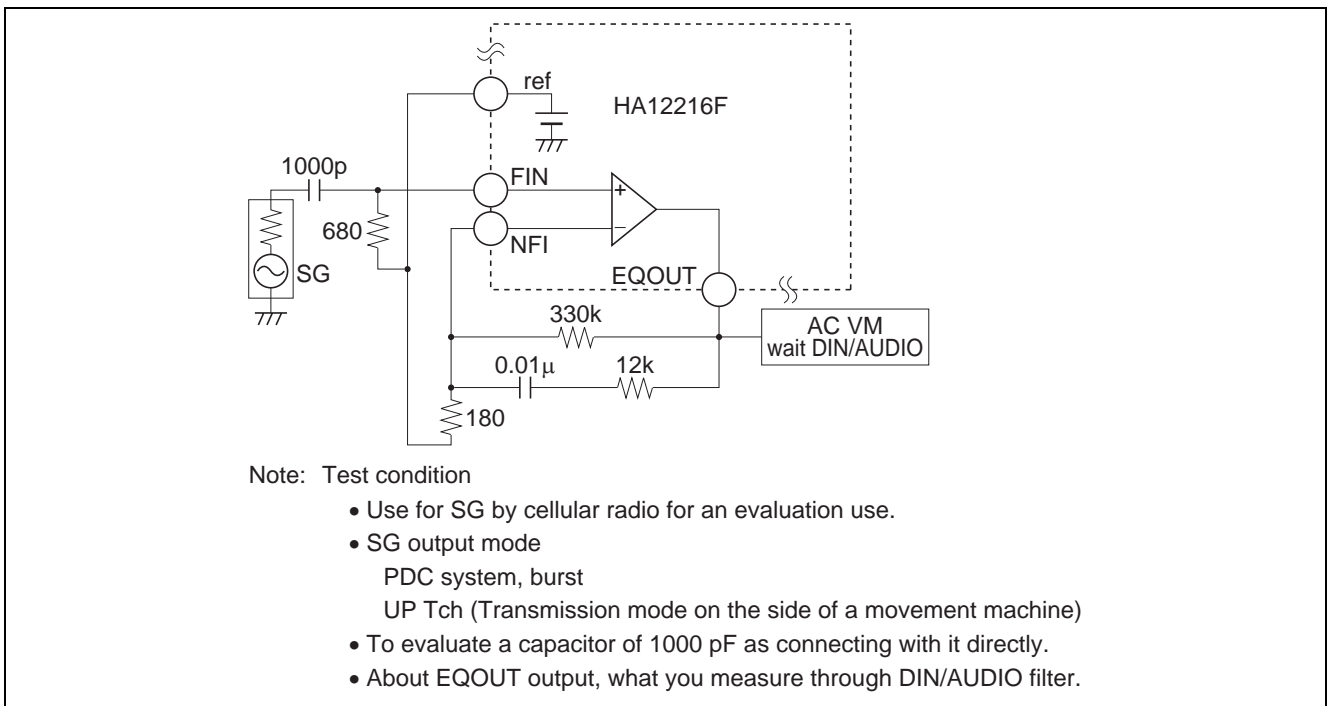

Figure 7 Test Circuit

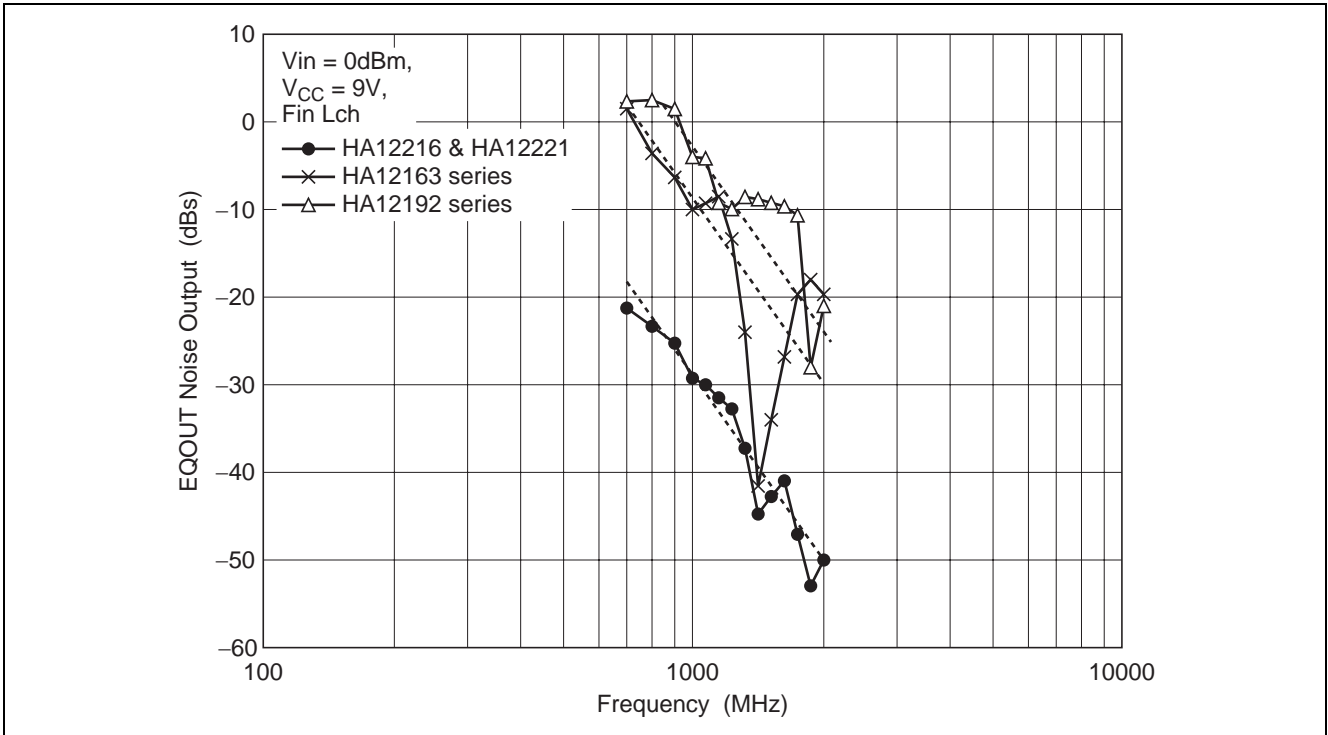

Figure 8 EQOUT Noise Output vs. Transmission Frequency Characteristic

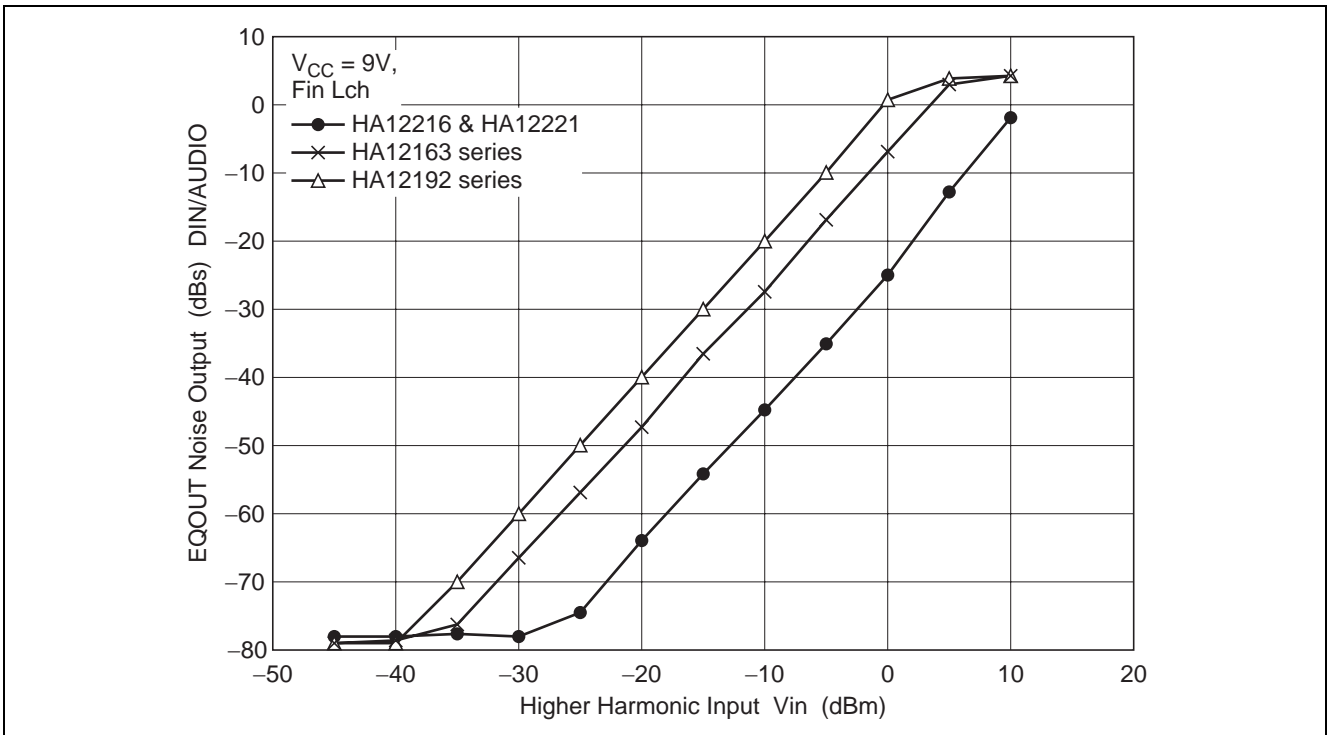

Figure 9 EQOUT Noise Output vs. Transmission

Absolute Maximum Ratings

(Ta = 25°C)

Item	Symbol	Rating	Unit	Note
Maximum supply voltage	V _{CC} Max	16	V	
Power dissipation	Pd	400	mW	Ta ≤ 85°C
Operating temperature	T _{opr}	-40 to +85	°C	
Storage temperature	T _{stg}	-55 to +125	°C	

Electrical Characteristics

HA12216F Series

(Ta = 25°C, V_{CC} = 9.0 V, P_{BOU}T Level 300 mVrms(HA12216F) 387.5 mVrms(HA12217F) 450 mVrms(HA12218F))

Item	Symbol	Test Condition										Min	Typ	Max	Unit	Application Terminal			Remark			
		IC Condition					Output									Input				Output		
		NR ON/OFF	120μ/70μ	F/R	T/R	S/R	Input	Output	f _{in} (Hz)	P _{BOU} T level (dB)	R					L	L	R		L	L	
Quiescent current	I _Q	ON	70μ	F	T	S	—	—	—	—	—	—	No signal	4.0	9.5	15.0	mA	—	—	—	16	
Input Amp. gain	G _v /A TAI	OFF	—	—	T	—	TAI	P _{BOU} T	1k	0	—	—	—	18.8	19.8	20.8	dB	3	28	6	25	
	G _v /A RAI	OFF	—	—	R	—	RAI	P _{BOU} T	1k	0	—	—	—	15.8	16.8	17.8	dB	5	26	—	—	
	G _v /A TAI	OFF	—	—	T	—	TAI	P _{BOU} T	1k	0	—	—	—	21.2	22.2	23.2	dB	3	28	—	—	
	G _v /A RAI	OFF	—	—	R	—	RAI	P _{BOU} T	1k	0	—	—	—	18.2	19.2	20.2	dB	5	26	—	—	
	G _v /A TAI	OFF	—	—	T	—	TAI	P _{BOU} T	1k	0	—	—	—	22.5	23.5	24.5	dB	3	28	—	—	
B-type decode cut	G _v /A RAI	OFF	—	—	R	—	RAI	P _{BOU} T	1k	0	—	—	—	19.5	20.5	21.5	dB	5	26	—	—	
	DEC-2k (1)	ON	—	—	T	—	TAI	P _{BOU} T	2k	-20	—	—	—	2.8	4.3	5.8	dB	3	28	6	25	
	DEC-2k (2)	ON	—	—	T	—	TAI	P _{BOU} T	2k	-30	—	—	—	7.0	8.5	10.0	dB	—	—	—	—	
	DEC-5k (1)	ON	—	—	T	—	TAI	P _{BOU} T	5k	-20	—	—	—	1.7	3.2	4.7	dB	—	—	—	—	
DEC-5k (2)	ON	—	—	T	—	TAI	P _{BOU} T	5k	-30	—	—	—	6.7	8.2	9.7	dB	—	—	—	—		
P _{BOU} T offset	V _{ofs}	OFF	—	—	T↔R	—	—	P _{BOU} T	—	—	—	—	V _{CC} =12V, No signal	-150	0.0	150	mV	3	28	6	25	
Signal handling	V _{o max}	ON	—	—	T	—	TAI	P _{BOU} T	1k	—	—	—	THD=1%	12.0	13.0	—	dB	3	28	6	25	
Signal to noise ratio	S/N	ON	—	—	T	—	TAI	P _{BOU} T	(1k)	(0)	—	—	Rg=10kΩ, CCIR/ARM	70.0	80.0	—	dB	(3)	(28)	6	25	
T.H.D.	THD	ON	—	—	T	—	TAI	P _{BOU} T	1k	0	—	—	—	—	0.05	0.3	%	3	28	6	25	
	CT RL (1)	OFF	—	—	R	—	RAI	P _{BOU} T	1k	(+12)	—	—	—	70.0	80.0	—	dB	3	28	6→25	25→6	
Channel separation	CT RL (2)	OFF	120μ	F	T	—	FIN	P _{BOU} T	1k	(+12)	—	—	—	50.0	60.0	—	dB	37	34	—	—	
	CT EQ→RAI	OFF	120μ	F	T→R	—	FIN	P _{BOU} T	1k	(+12)	—	—	—	70.0	80.0	—	dB	37	34	6	25	
Crosstalk	CT RAI→EQ	OFF	120μ	F	R→T	—	RAI	P _{BOU} T	1k	(+12)	—	—	—	50.0	60.0	—	dB	5	26	—	—	
	G _v /EQ 1k	—	120μ	F/R	—	—	FIN/RIN	EQOUT	1k	—	—	—	V _{in} =0.6mVrms	37.0	40.0	43.0	dB	37/39	34/32	2	29	
PB-EQ gain	G _v /EQ 10k(1)	—	120μ	F	—	—	FIN	EQOUT	10k	—	—	—	—	33.0	36.0	39.0	dB	37	34	—	—	
	G _v /EQ 10k(2)	—	70μ	F	—	—	FIN	EQOUT	10k	—	—	—	—	29.0	32.0	35.0	dB	37	34	—	—	
PB-EQ Max output level	V _{OH}	—	120μ	F/R	—	—	FIN	EQOUT	1k	—	—	—	THD=1%	300	600	—	mVrms	37/39	34/32	2	29	
	THD-EQ	—	120μ	F/R	—	—	FIN/RIN	EQOUT	1k	—	—	—	V _{in} =3mVrms	—	0.1	0.3	%	37/39	34/32	2	29	
Noise level converted in input	V _N	—	120μ	F/R	—	—	FIN/RIN	EQOUT	(1k)	—	—	—	Rg=680Ω, DIN-AUDIO	—	0.7	1.5	μVrms	(37/39)	(34/32)	2	29	
	V _{ON} (1)	—	—	—	T	R	TAI	P _{BOU} T	5k	—	—	—	—	-36	-32	-28	dB	3	28	2	29	
MS sensitivity level	V _{ON} (2)	—	—	—	T	S	TAI	P _{BOU} T	5k	—	—	—	—	-18	-14	-10	dB	—	—	—	15	
	V _{OL}	—	—	—	T	S	TAI	MSOUT	5k	0	—	—	—	—	1.0	1.5	V	3	28	—	15	
MS output low level	I _{OH}	—	—	—	—	—	—	MSOUT	—	—	—	—	No signal	—	0.0	2.0	μA	—	—	—	15	
	V _{IL}	—	—	—	—	—	—	—	—	—	—	—	—	-0.2	—	1.0	V	—	—	—	10 to 14	
Control voltage	V _{IH}	—	—	—	—	—	—	—	—	—	—	—	—	3.5	—	V _{CC}	—	—	—	—	—	

Note: 1. HA12216F: V_{CC} = 6.5V
 HA12217F: V_{CC} = 6.8V
 HA12218F: V_{CC} = 7.2V

HA12221F Series

(Ta = 25°C, V_{CC} = 9.0 V, PBOUIT Level 300 mVrms(HA12221F) 387.5 mVrms(HA12222F) 450 mVrms(HA12223F))

Item	Symbol	Test Condition										Application Terminal				Remark			
		IC Condition					Test Condition					Input		Output					
		120μV 70μV	F/R	T/R	S/R	S	Input	Output	f _{in} (Hz)	PBOUIT level (dB)	Min	Typ	Max	Unit	R		L	R	L
Quiescent current	I _Q	70μV	F	T	S	—	—	—	—	—	No signal	3.0	5.0	8.0	mA	—	—	—	16
Input Amp. gain	G _{V/A} TAI	—	—	T	—	TAI	PBOUIT	1k	0	—	—	19.0	20.0	21.0	dB	3	28	6	25
	G _{V/A} RAI	—	—	R	—	RAI	PBOUIT	1k	0	—	—	16.0	17.0	18.0	dB	5	26	—	—
	G _{V/A} TAI	—	—	T	—	TAI	PBOUIT	1k	0	—	—	21.2	22.2	23.2	dB	3	28	—	—
HA12222F	G _{V/A} RAI	—	—	R	—	RAI	PBOUIT	1k	0	—	—	18.2	19.2	20.2	dB	5	26	—	—
	G _{V/A} TAI	—	—	T	—	TAI	PBOUIT	1k	0	—	—	22.5	23.5	24.5	dB	3	28	—	—
	G _{V/A} RAI	—	—	R	—	RAI	PBOUIT	1k	0	—	—	19.5	20.5	21.5	dB	5	26	—	—
PBOUIT offset	V _{ofs}	—	—	T↔R	—	—	PBOUIT	—	—	—	V _{CC} =12V, No signal	-15.0	0.0	15.0	mV	3	28	6	25
Signal handling	V _{o max}	—	—	T	—	TAI	PBOUIT	1k	—	—	THD=1%	12.0	13.0	—	dB	3	28	6	25
Signal to noise ratio	S/N	—	—	T	—	TAI	PBOUIT	(1k)	(0)	—	R _g =10kΩ, CCIR/ARM	70.0	80.0	—	dB	(3)	(28)	6	25
T.H.D.	THD	—	—	T	—	TAI	PBOUIT	1k	0	—	—	—	0.05	0.3	%	3	28	6	25
Channel separation	CT RL (1)	—	—	R	—	RAI	PBOUIT	1k	(+12)	—	—	70.0	80.0	—	dB	3	28	6	25
	CT RL (2)	120μV	F	T	—	FIN	PBOUIT	1k	(+12)	—	—	50.0	60.0	—	dB	37	34	6	25
	CT EQ→RAI	120μV	F	T→R	—	FIN	PBOUIT	1k	(+12)	—	—	70.0	80.0	—	dB	37	34	6	25
Crosstalk	CT RAI→EQ	120μV	F	R→T	—	RAI	PBOUIT	1k	(+12)	—	—	50.0	60.0	—	dB	5	26	—	—
	G _V EQ 1k	120μV	F/R	—	—	FIN/RIN	EQOUT	1k	—	—	V _{in} =0.6mVrms	37.0	40.0	43.0	dB	37/39	34/32	2	29
	G _V EQ 10k(1)	120μV	F	—	—	FIN	EQOUT	10k	—	—	—	33.0	36.0	39.0	dB	37	34	—	—
PB-EQ gain	G _V EQ 10k(2)	70μV	F	—	—	FIN	EQOUT	10k	—	—	—	29.0	32.0	35.0	dB	37	34	—	—
	V _{OM}	120μV	F/R	—	—	FIN	EQOUT	1k	—	—	THD=1%	300	600	—	mVrms	37/39	34/32	2	29
	THD-EQ	120μV	F/R	—	—	FIN/RIN	EQOUT	1k	—	—	V _{in} =3mVrms	—	0.1	0.3	%	37/39	34/32	2	29
Noise level converted in input	V _N	120μV	F/R	—	—	FIN/RIN	EQOUT	(1k)	—	—	R _g =680Ω, DIN-AUDIO	—	0.7	1.5	μVrms	(37/39)	(34/32)	2	29
MS sensitivity level	V _{ON} (1)	—	—	T	R	TAI	PBOUIT	5k	—	—	—	-36	-32	-28	dB	3	28	2	29
	V _{ON} (2)	—	—	T	S	TAI	PBOUIT	5k	—	—	—	-18	-14	-10	dB	—	—	—	15
MS output low level	V _{OL}	—	—	T	S	TAI	MSOUT	5k	0	—	—	—	1.0	1.5	V	3	28	—	15
MS output leak current	I _{OH}	—	—	—	—	—	MSOUT	—	—	—	No signal	—	0.0	2.0	μA	—	—	—	15
Control voltage	V _{IL}	—	—	—	—	—	—	—	—	—	—	-0.2	—	—	V	—	—	—	10 to 14
	V _{IH}	—	—	—	—	—	—	—	—	—	—	3.5	—	V _{CC}	—	—	—	—	—

Note: 1. HA12221F: V_{CC} = 6.5V
 HA12222F: V_{CC} = 6.8V
 HA12223F: V_{CC} = 7.2V

Test Circuit

HA12216F Series

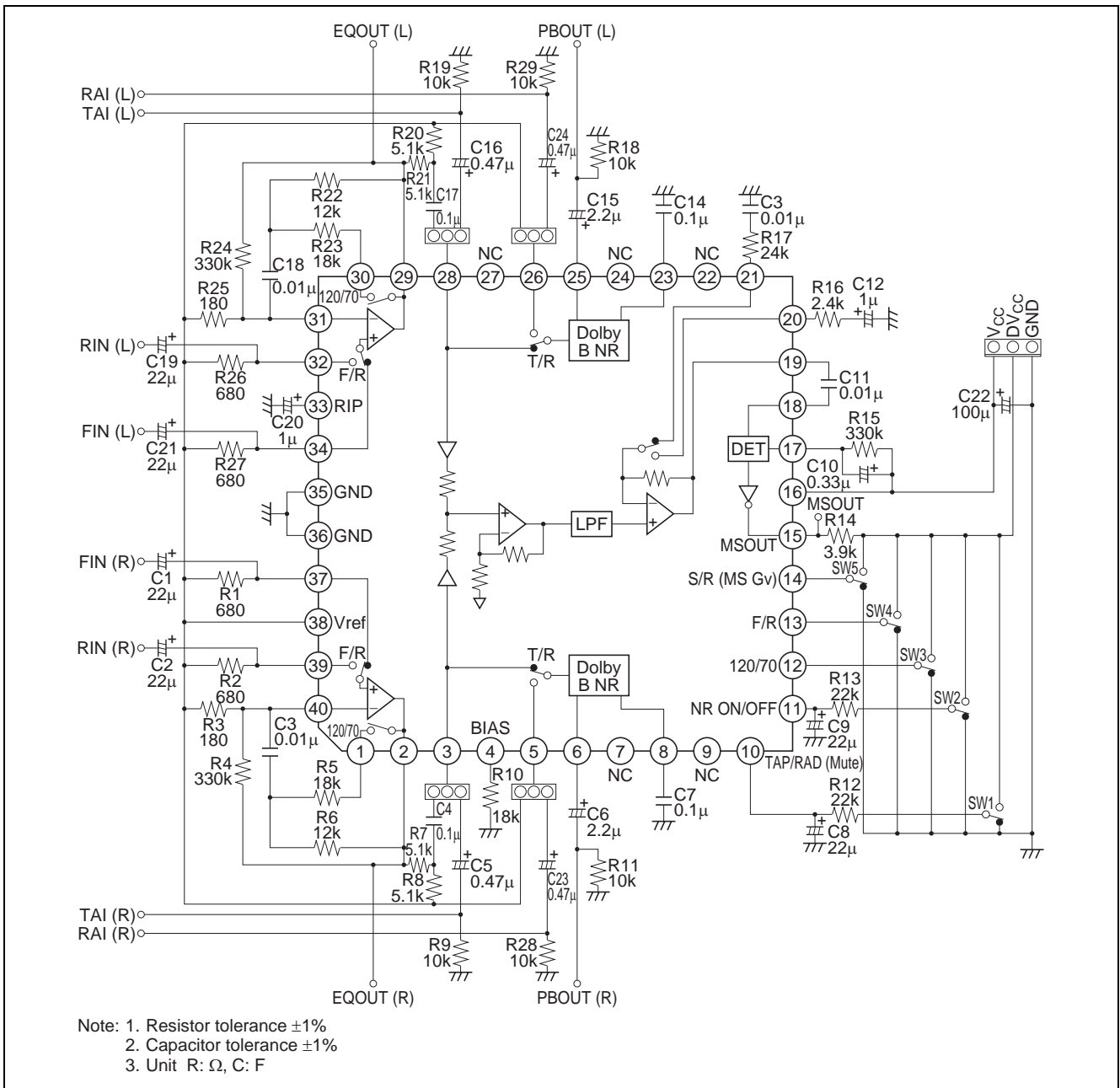

HA12221F Series

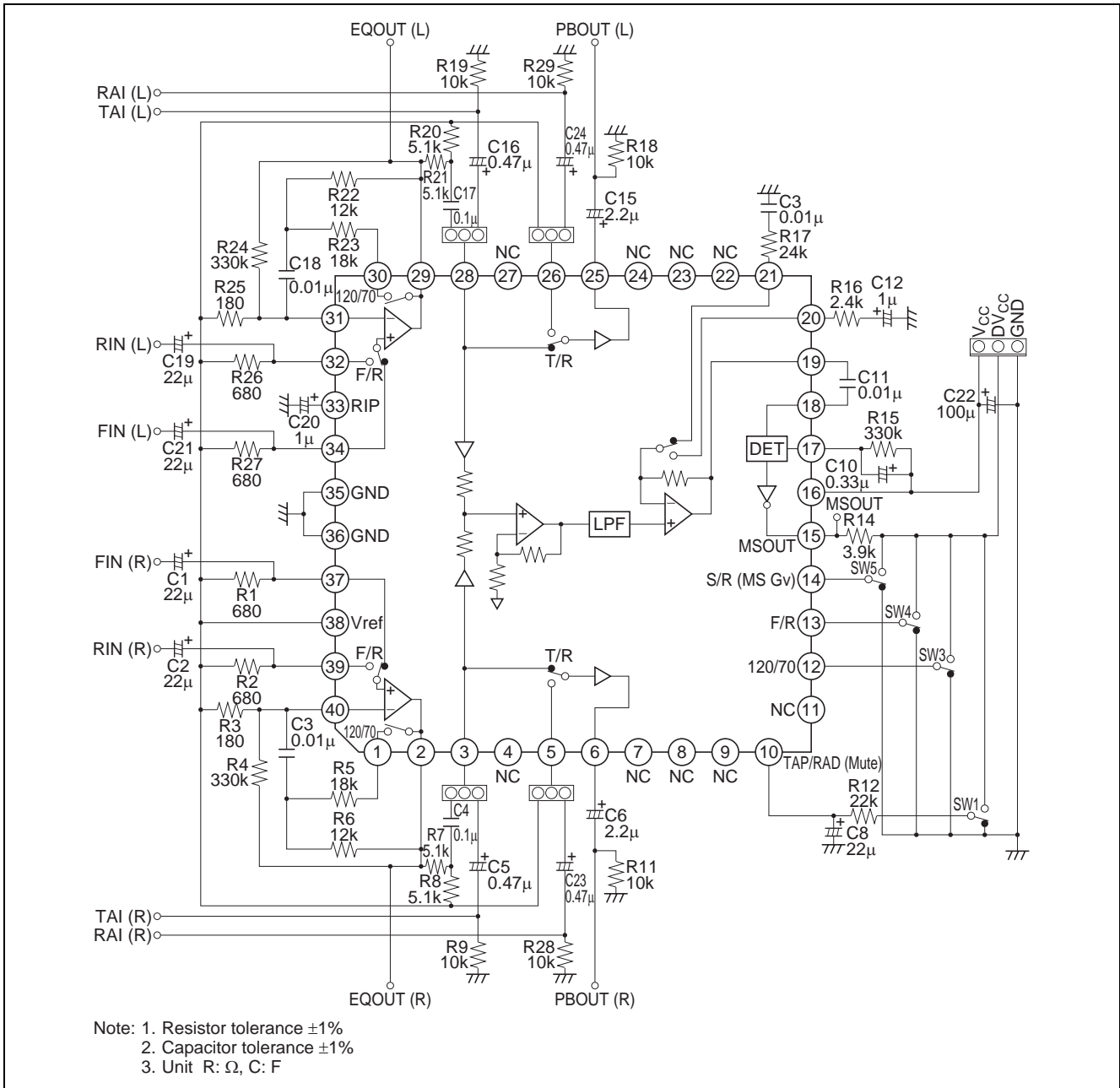

Characteristic Curves

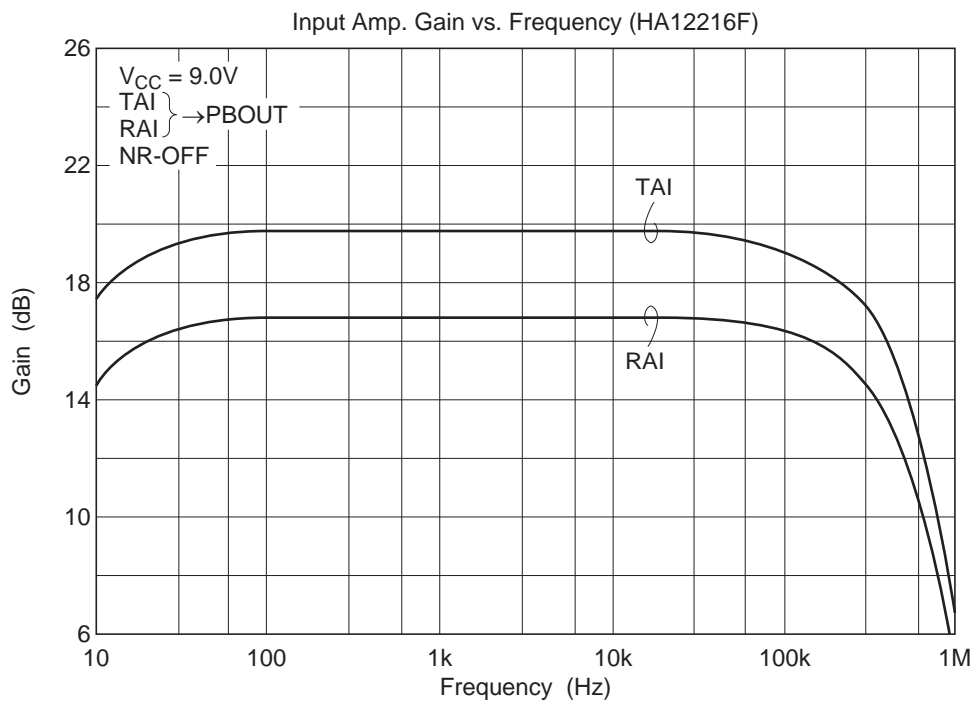
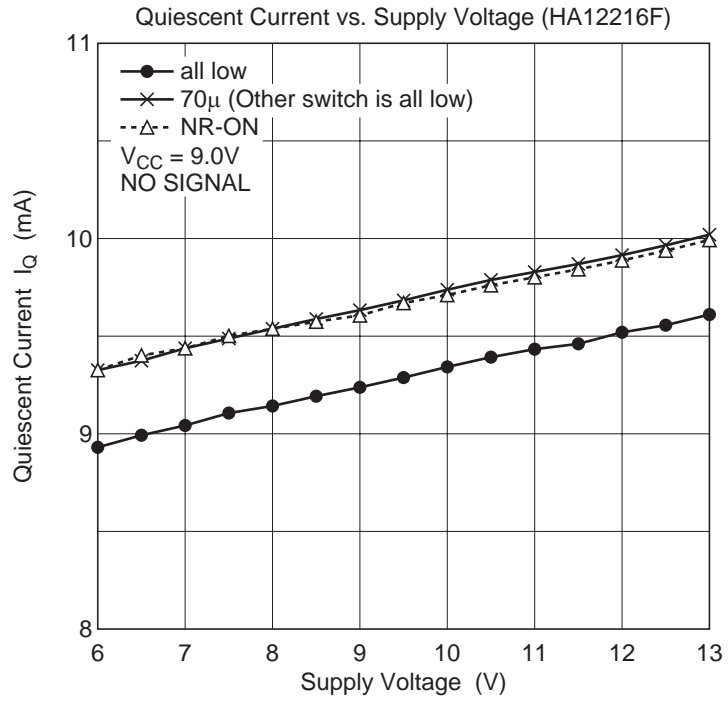

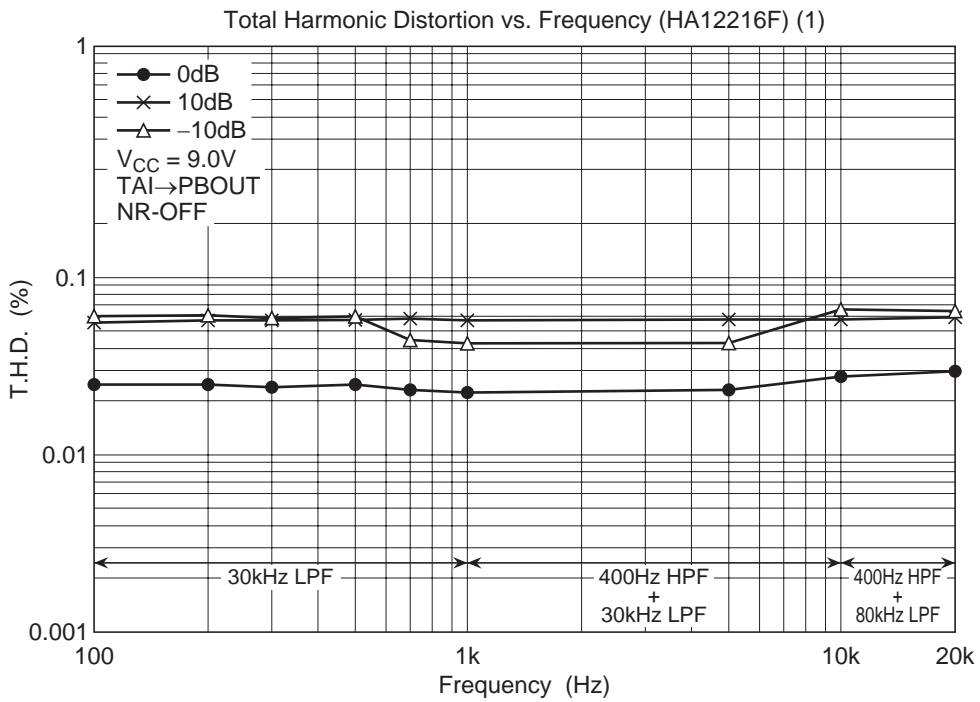
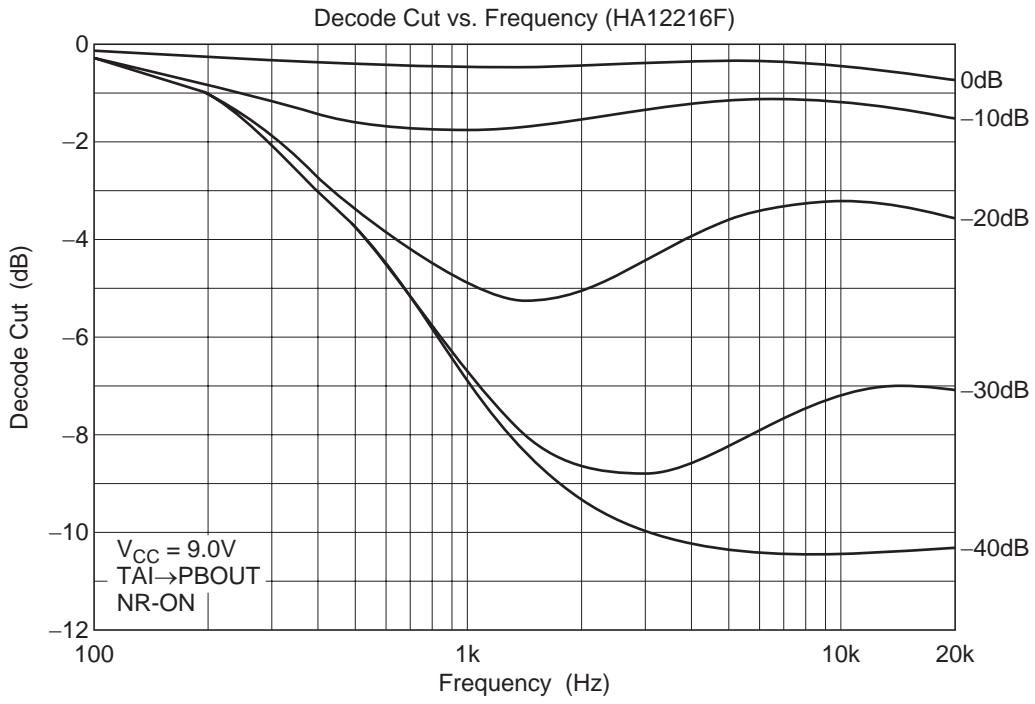

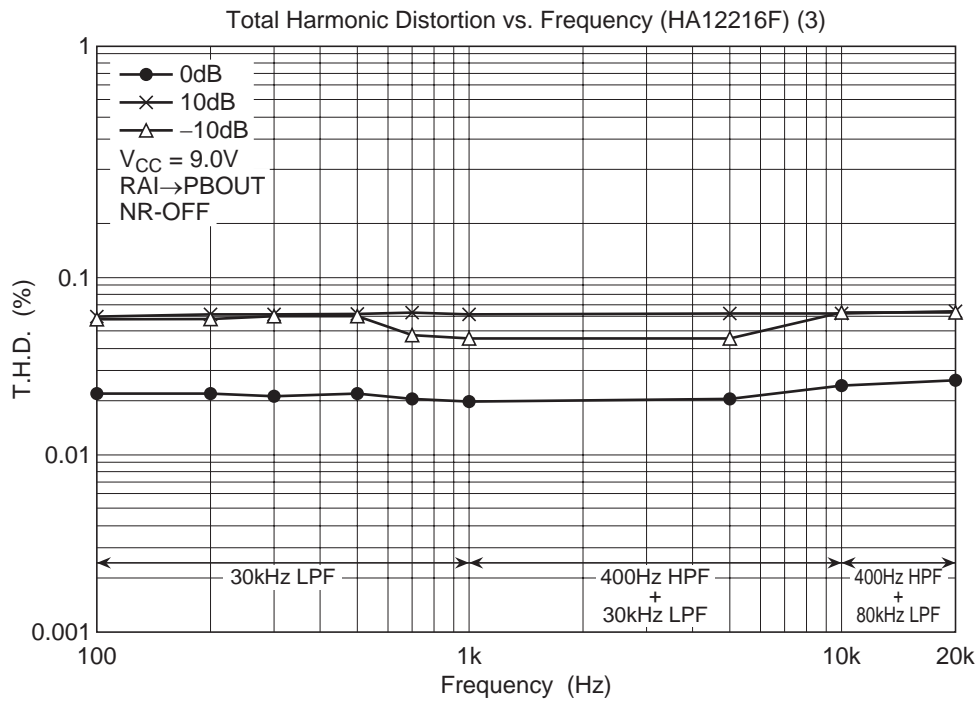
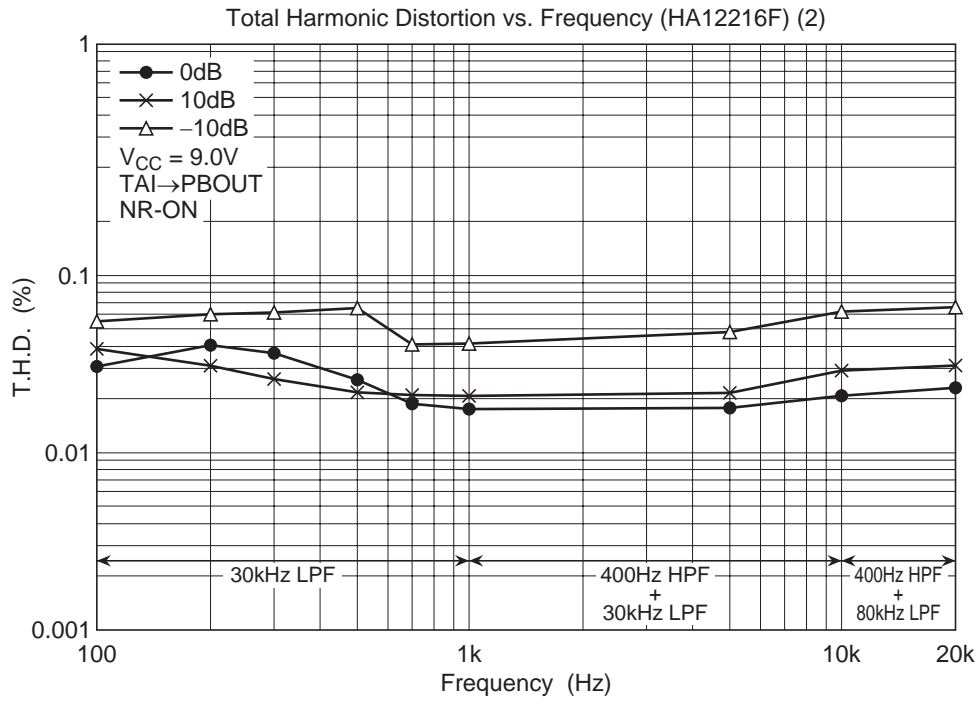

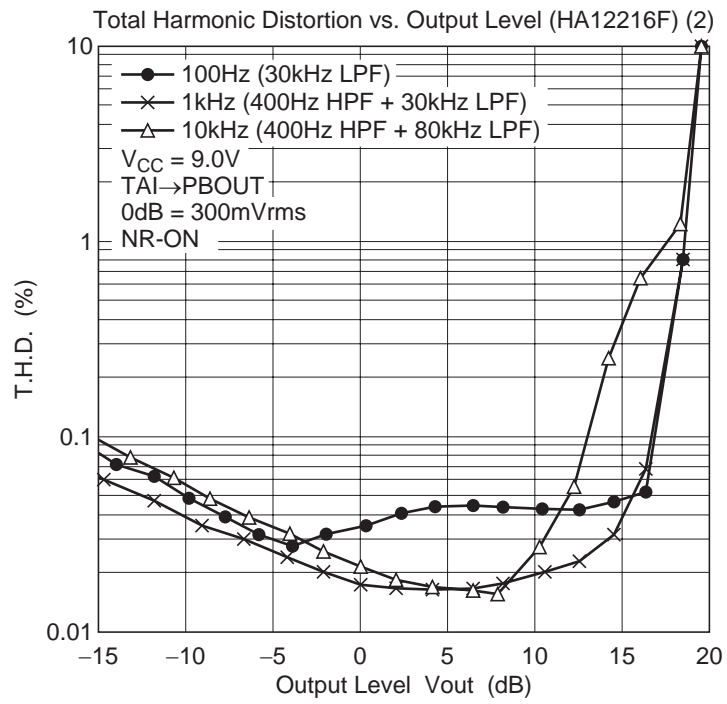
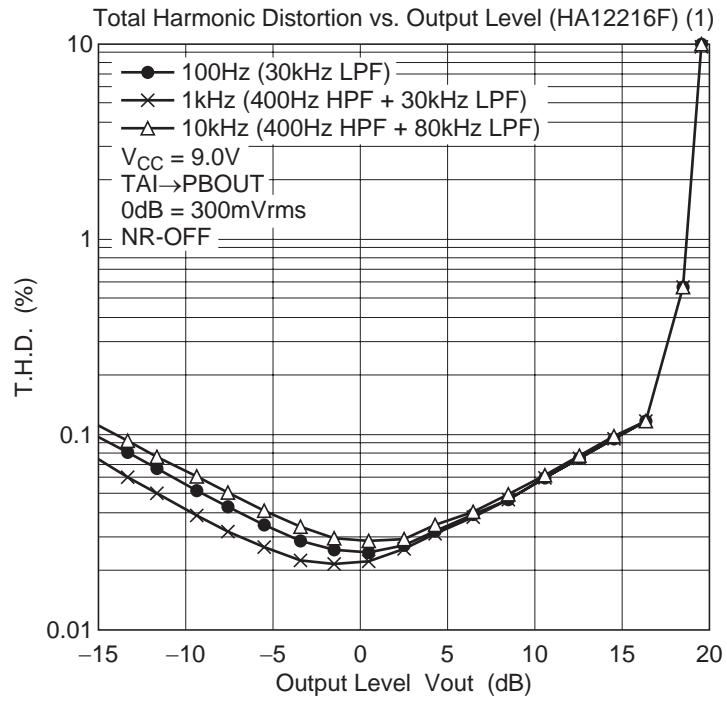

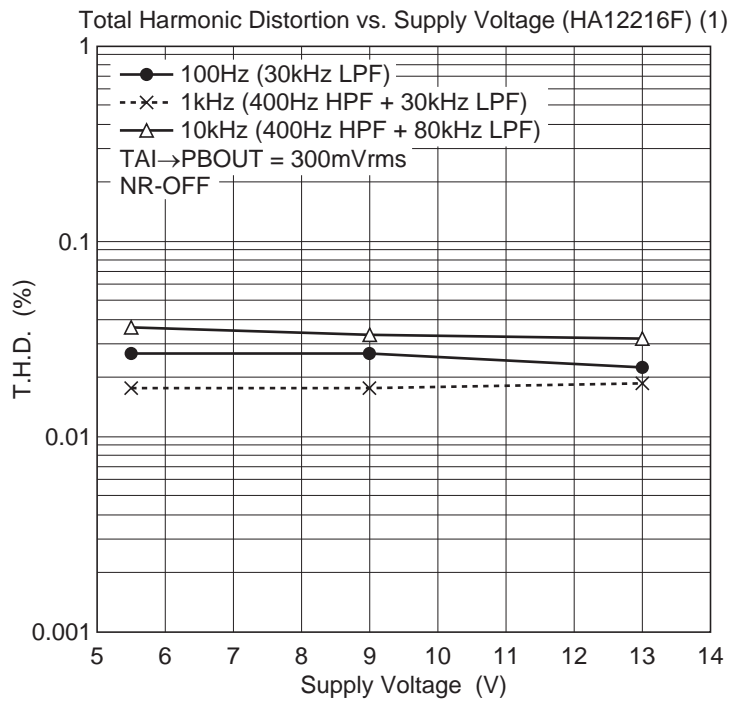
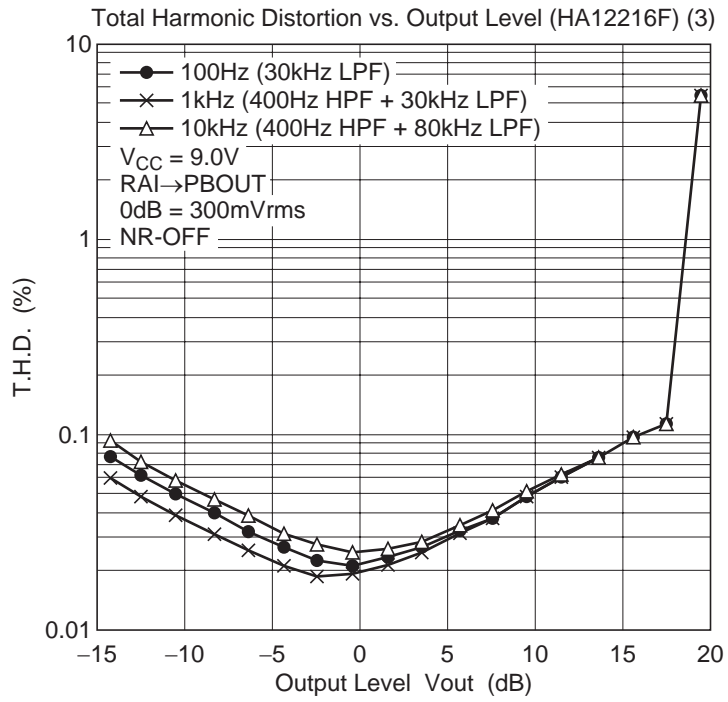

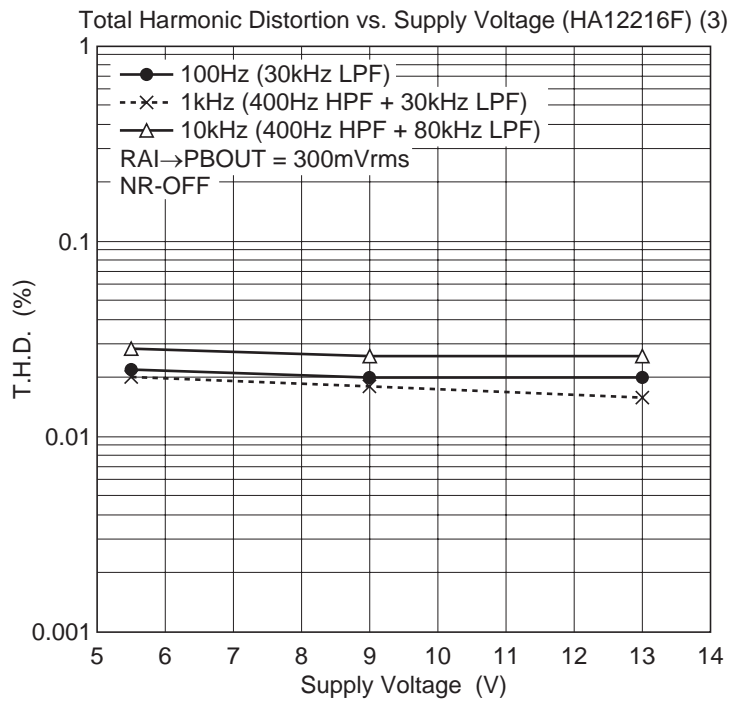
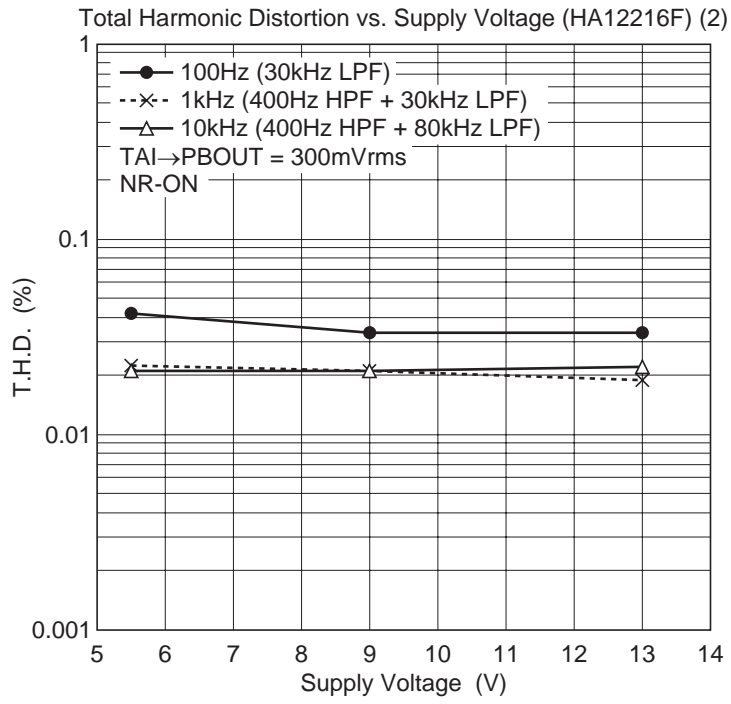

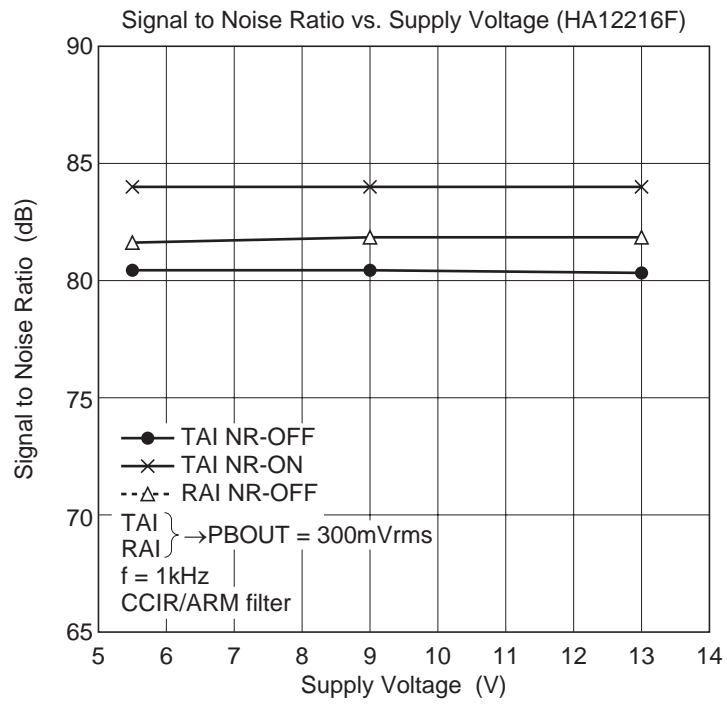
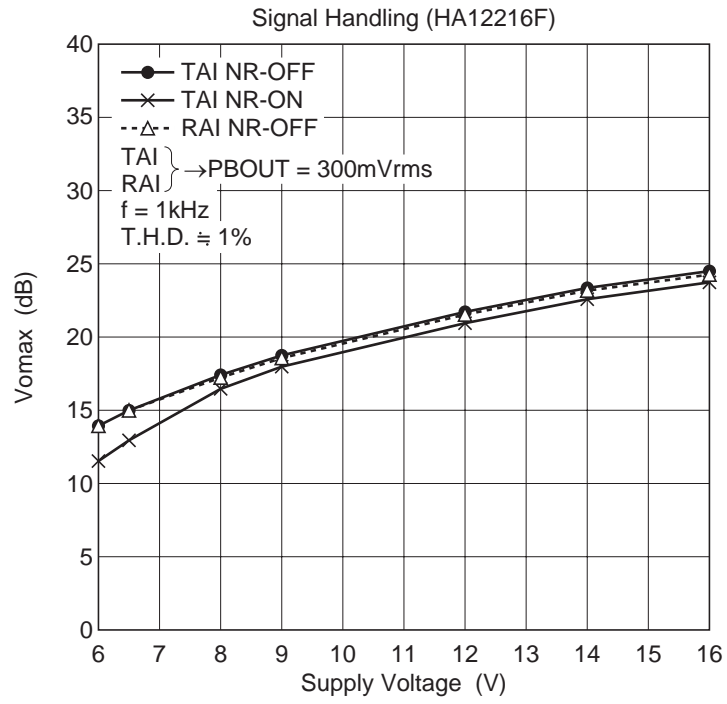

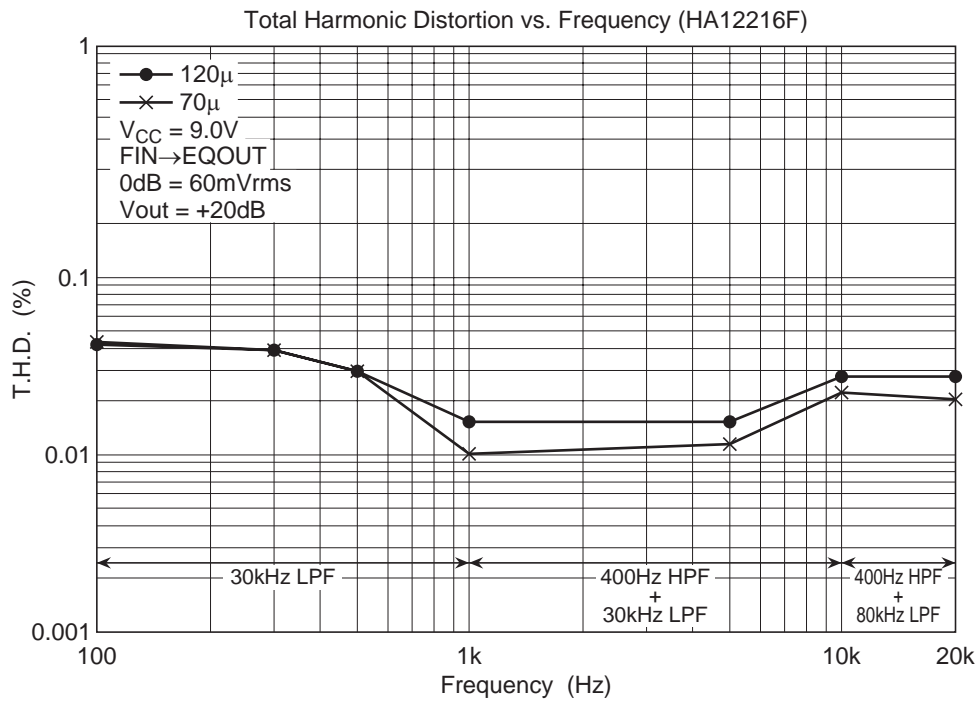
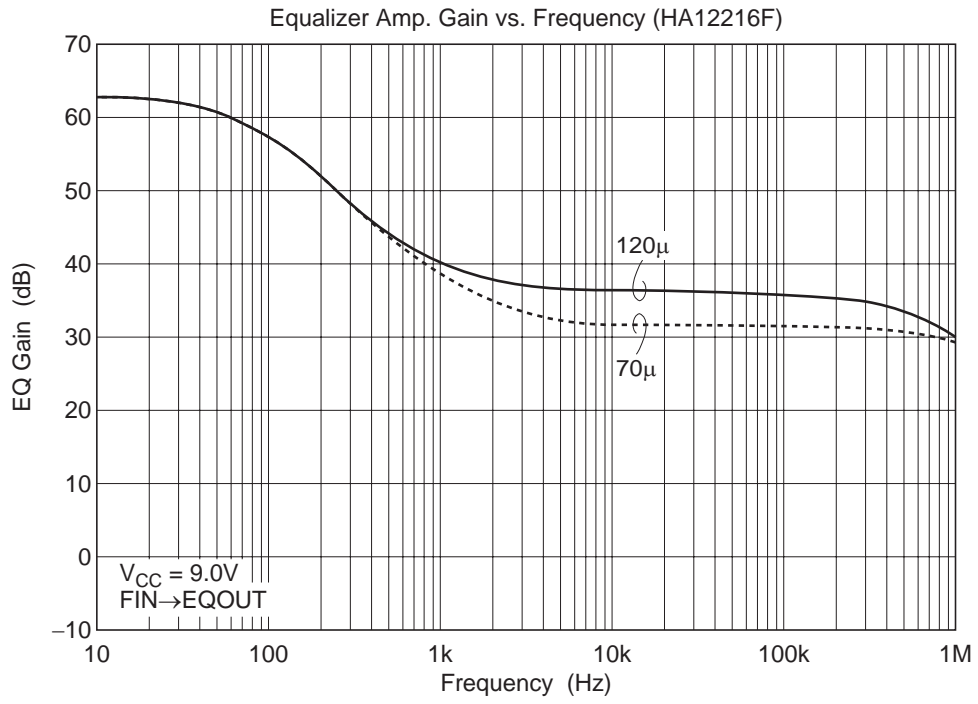

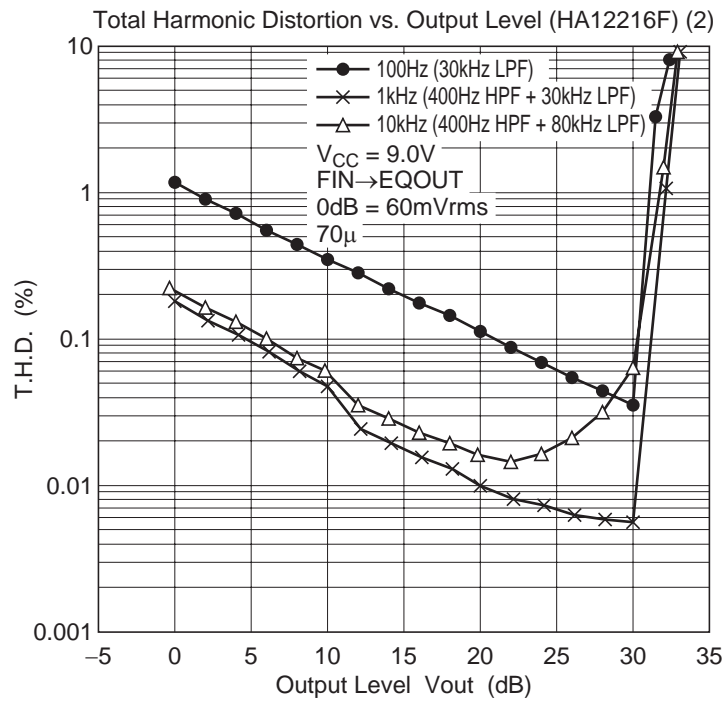
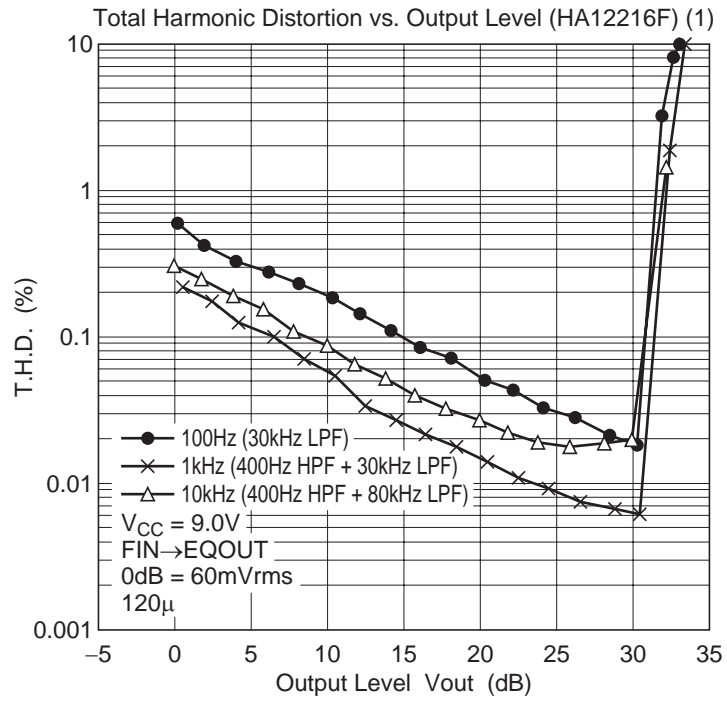

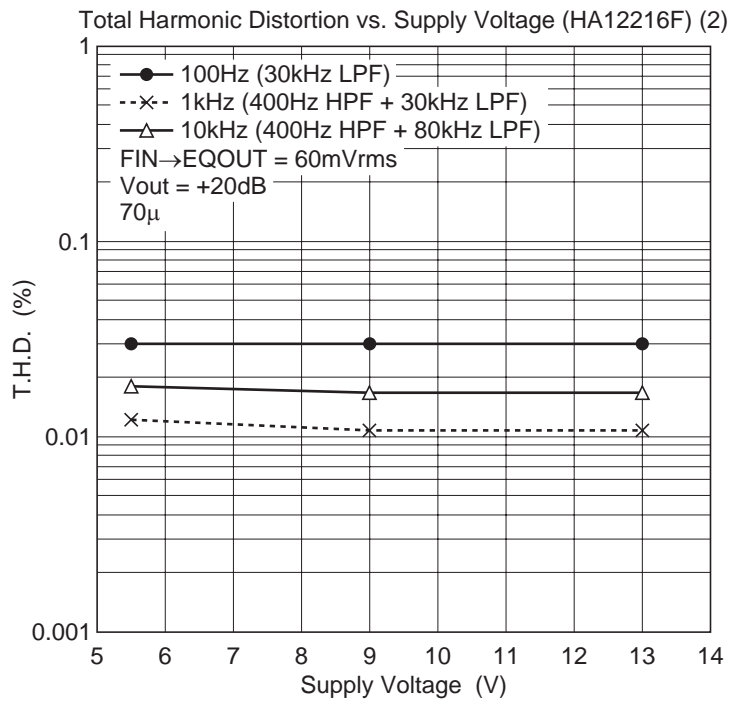
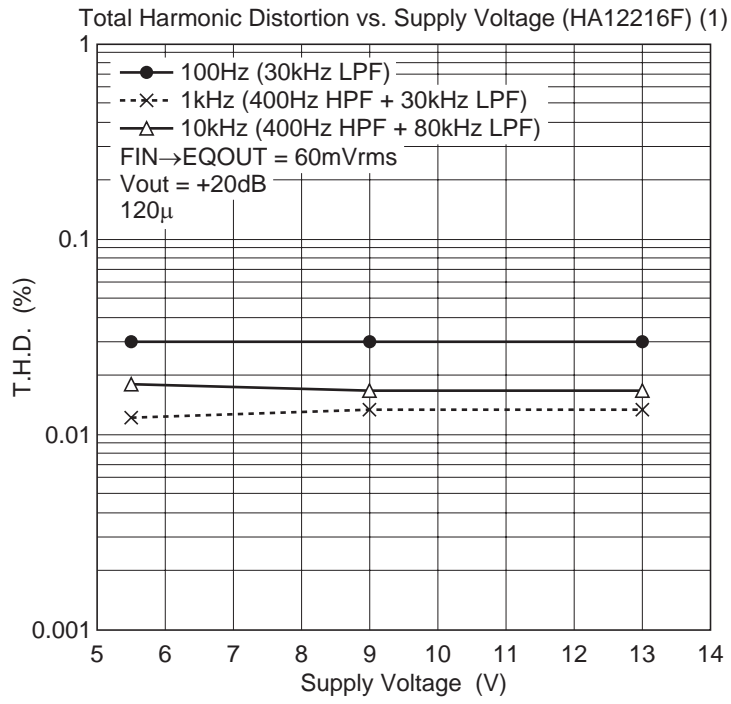

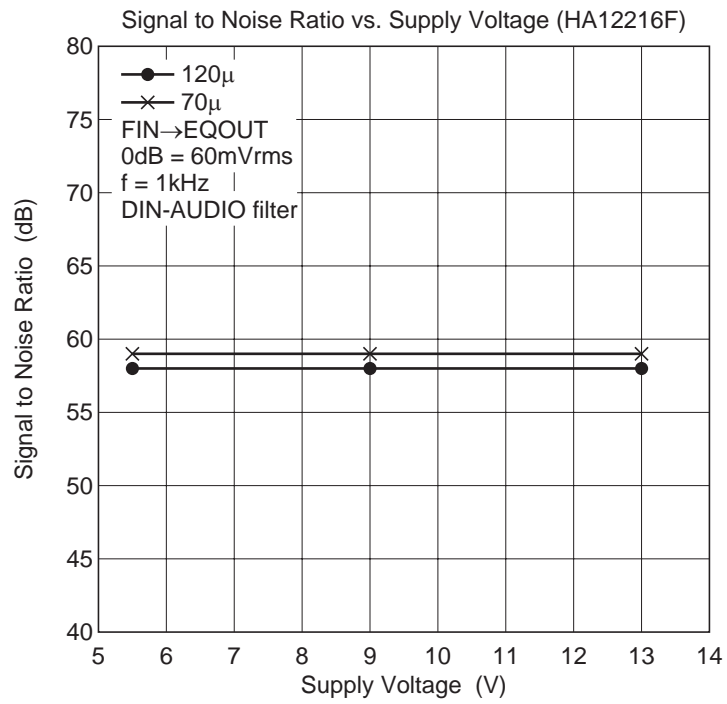
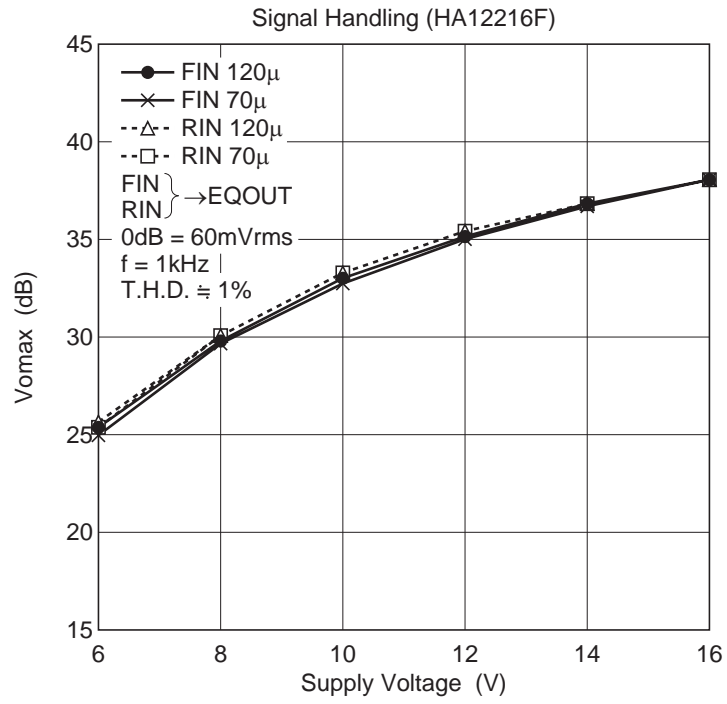

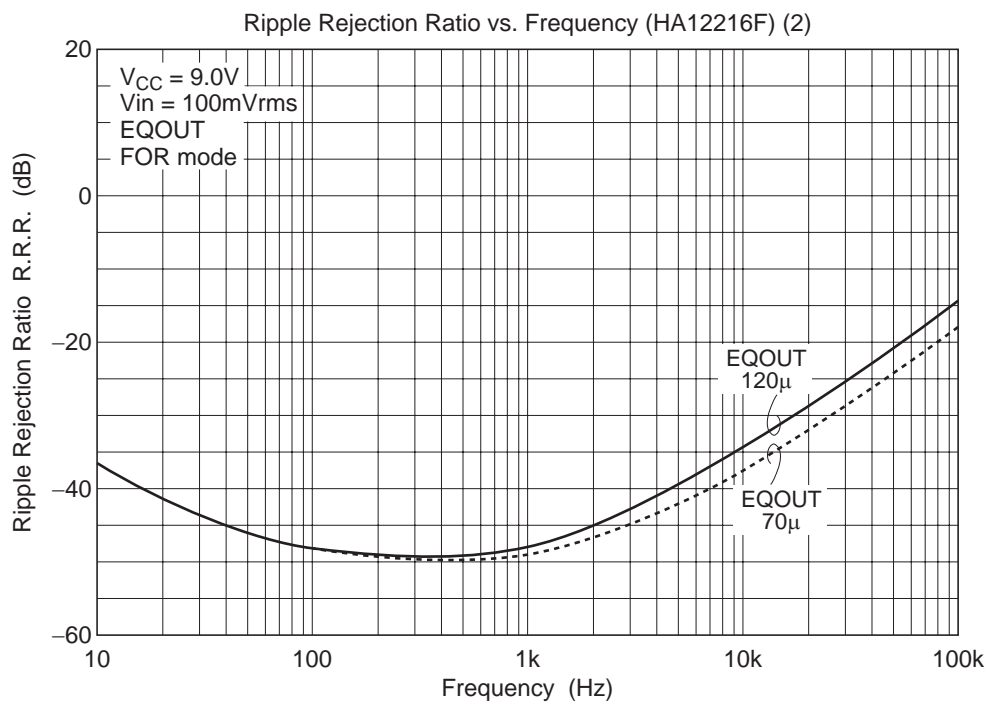
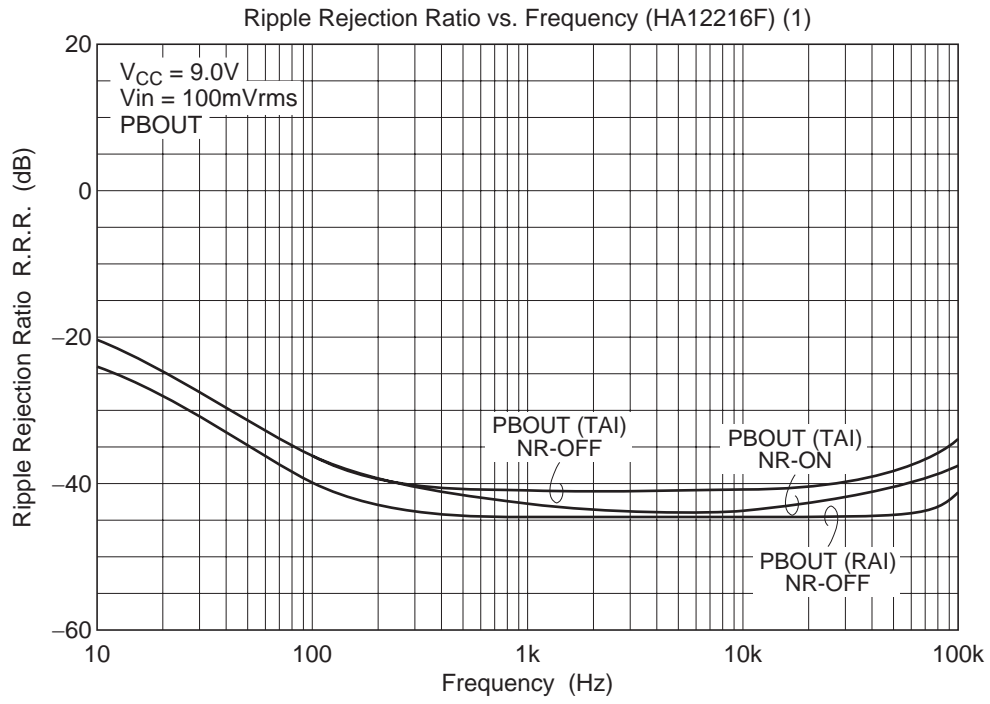

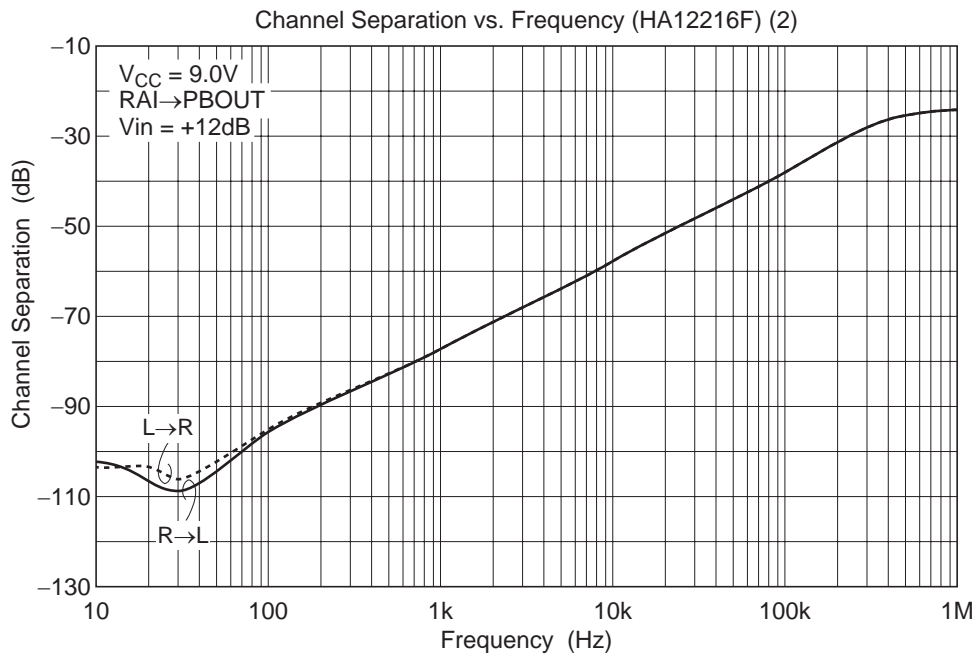
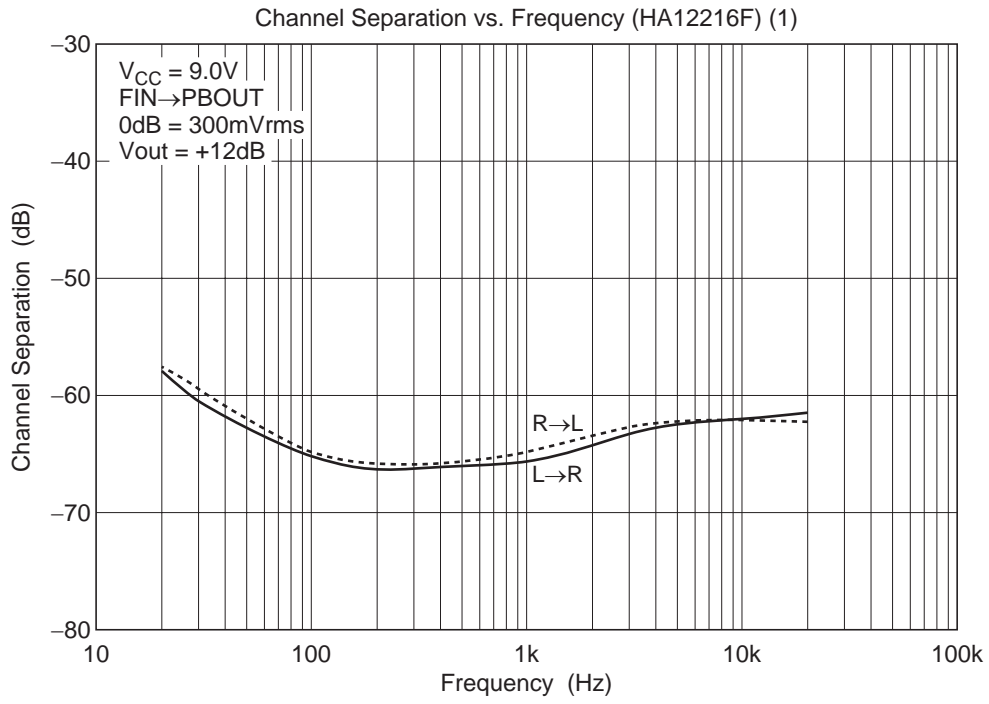

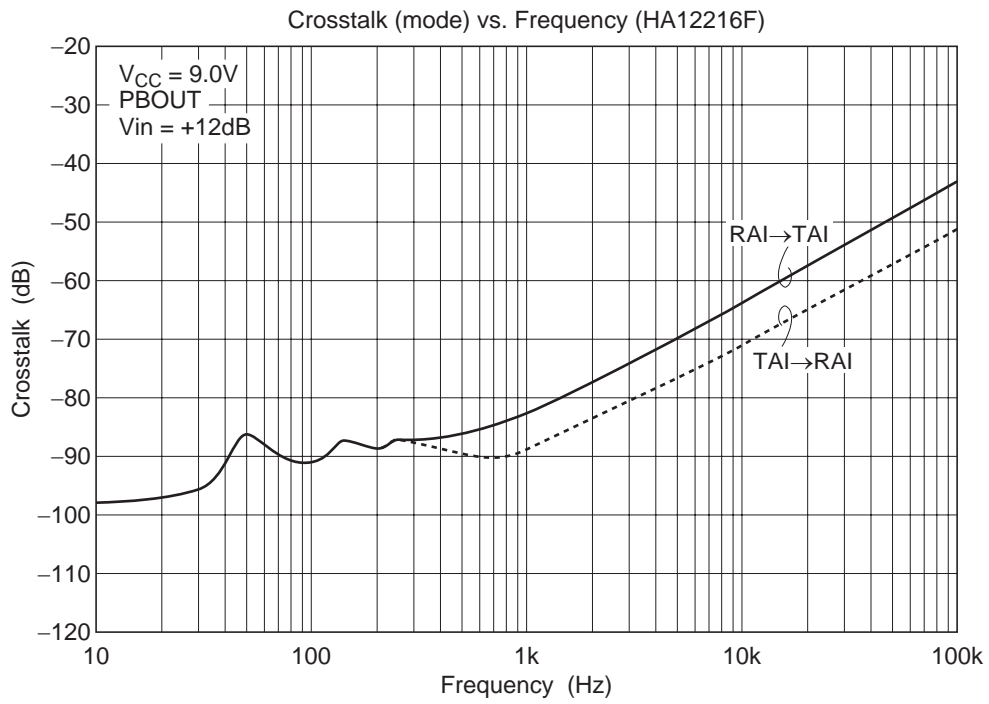
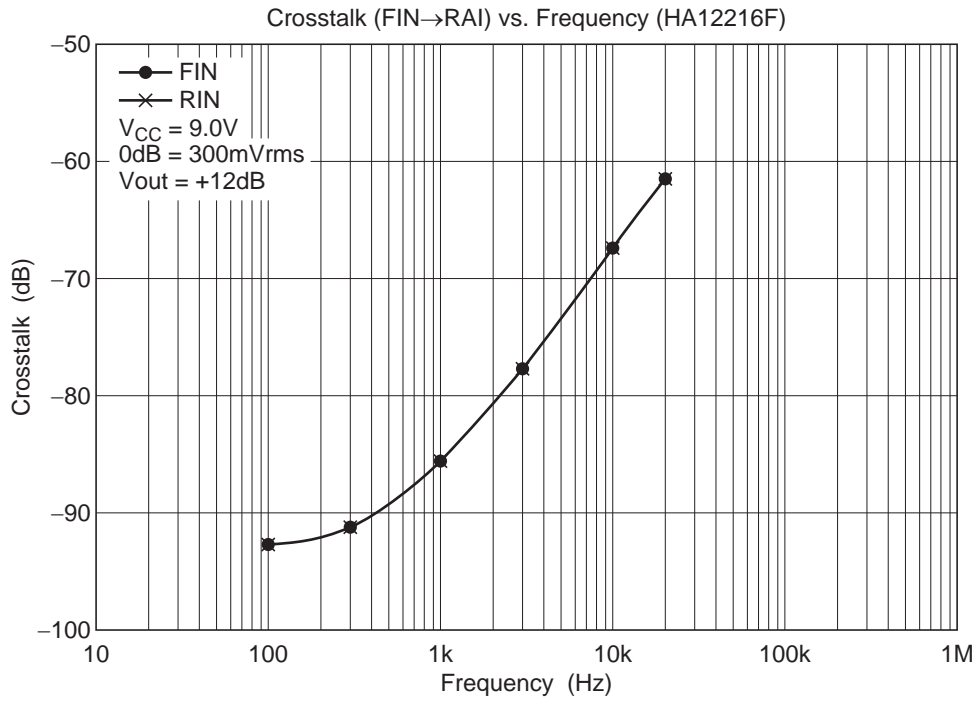

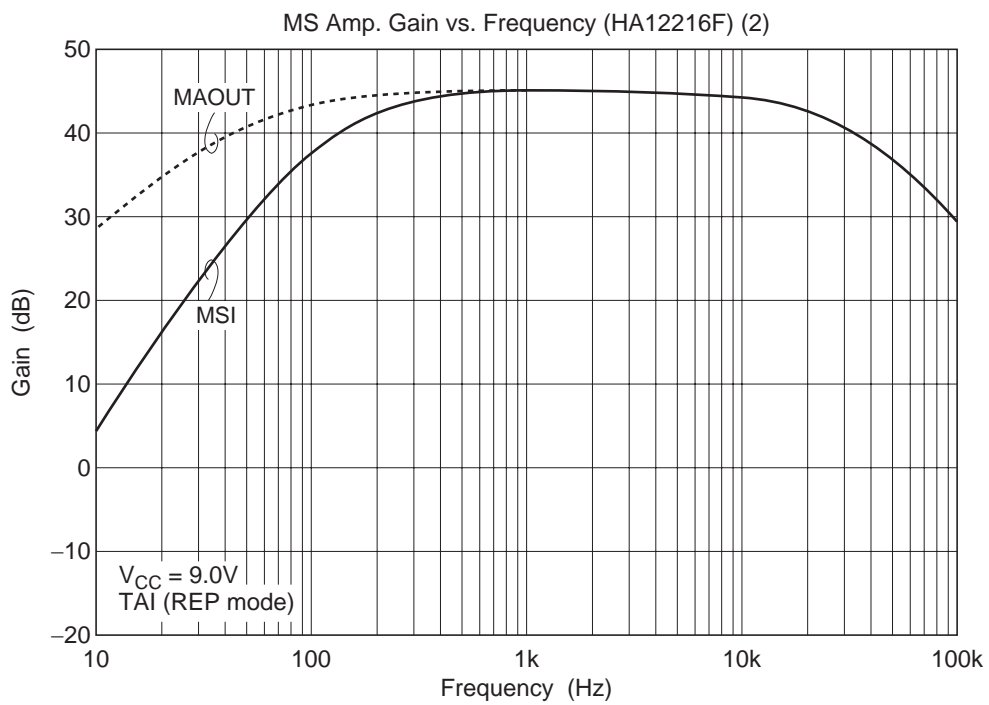
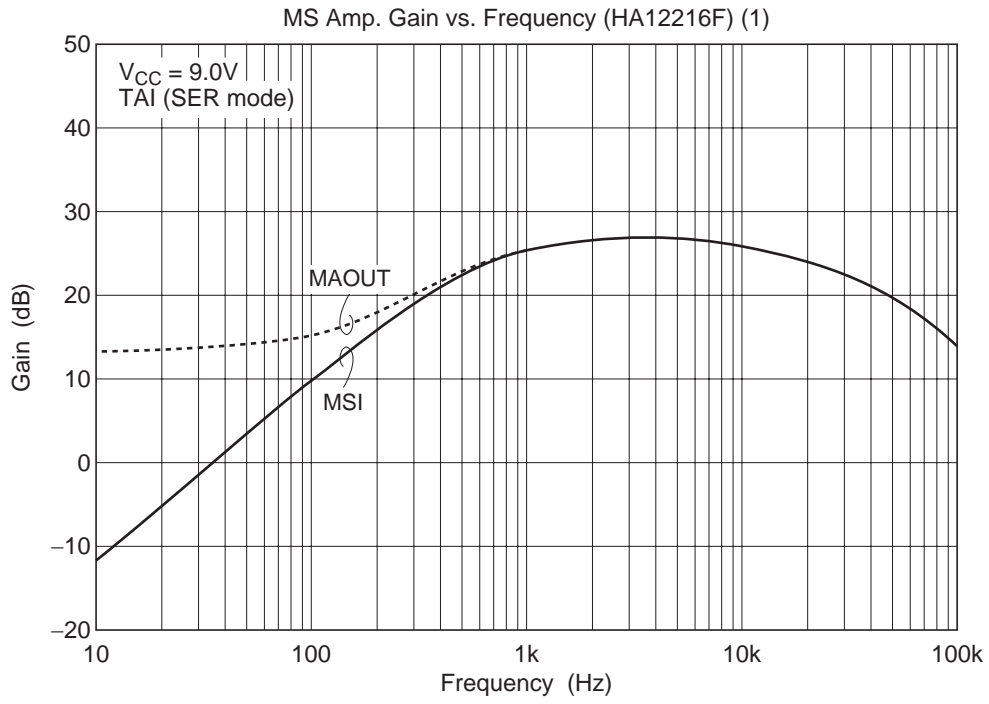

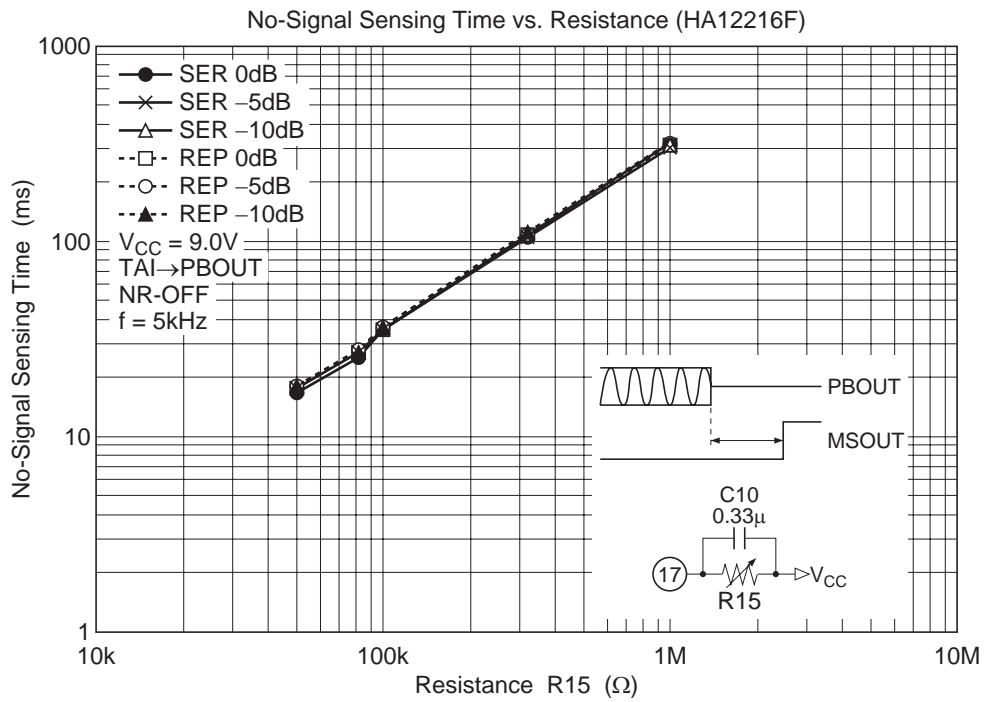
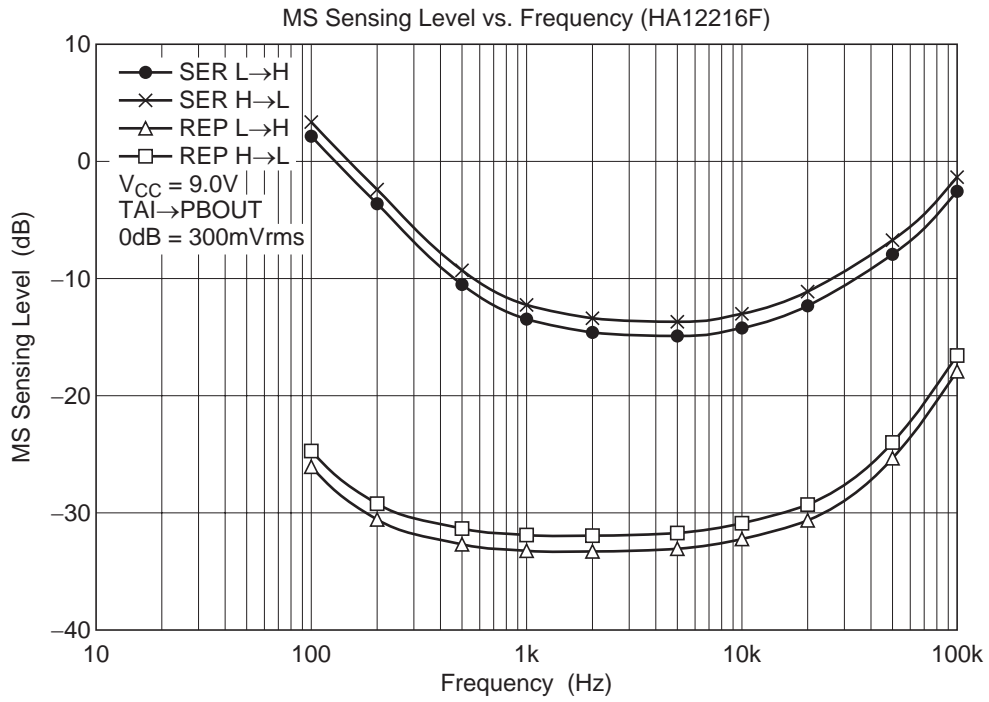

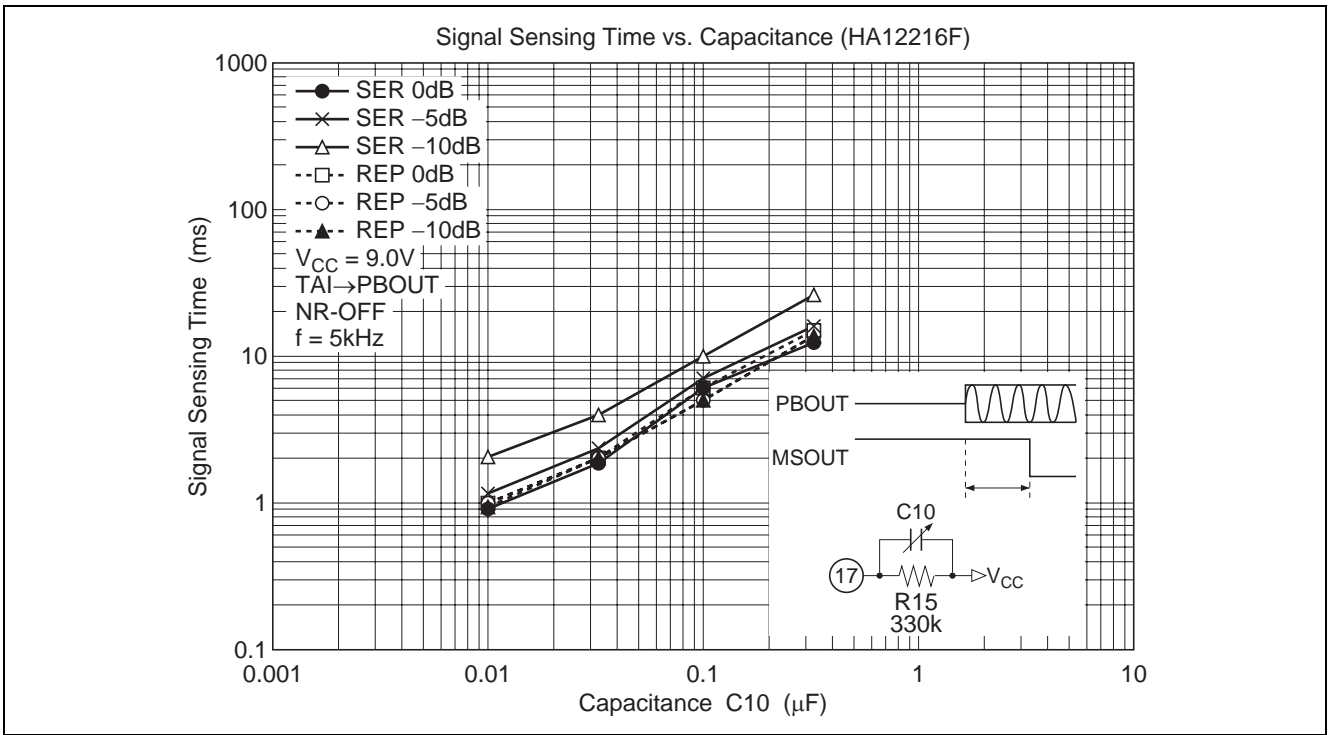

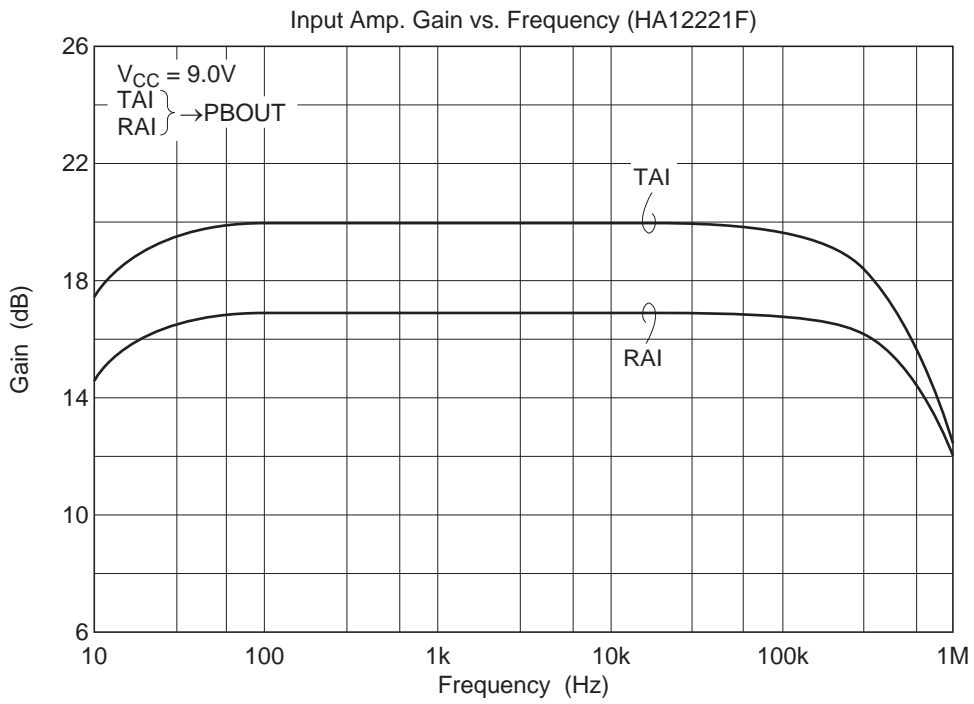
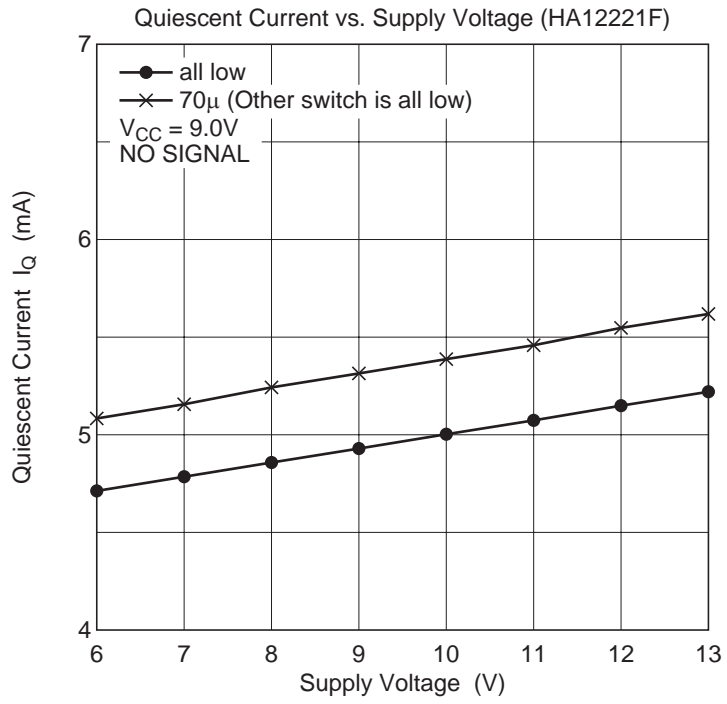

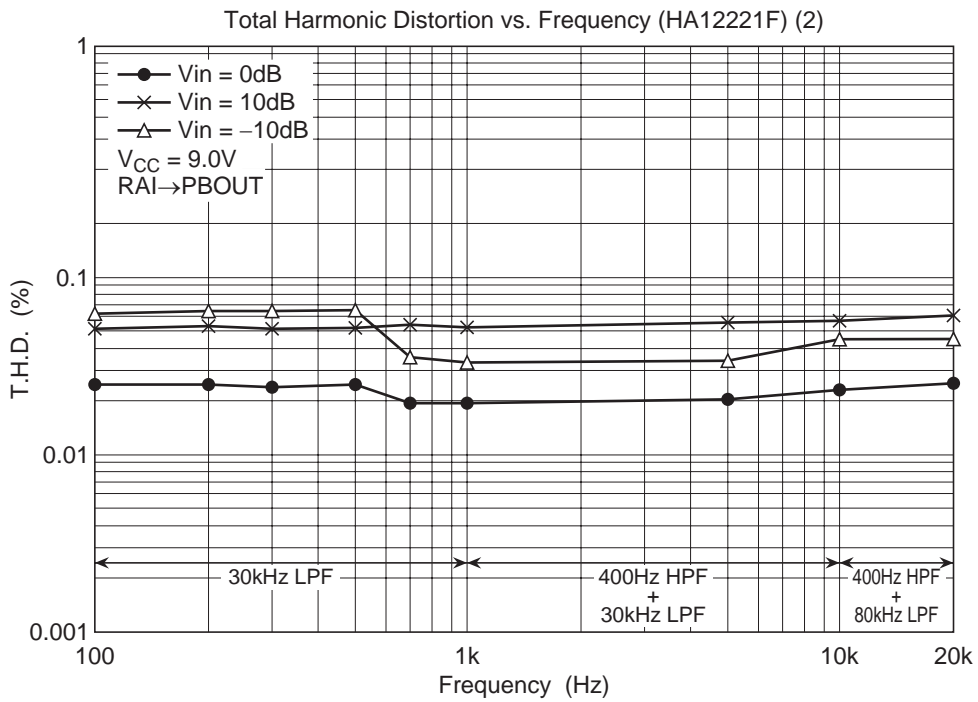
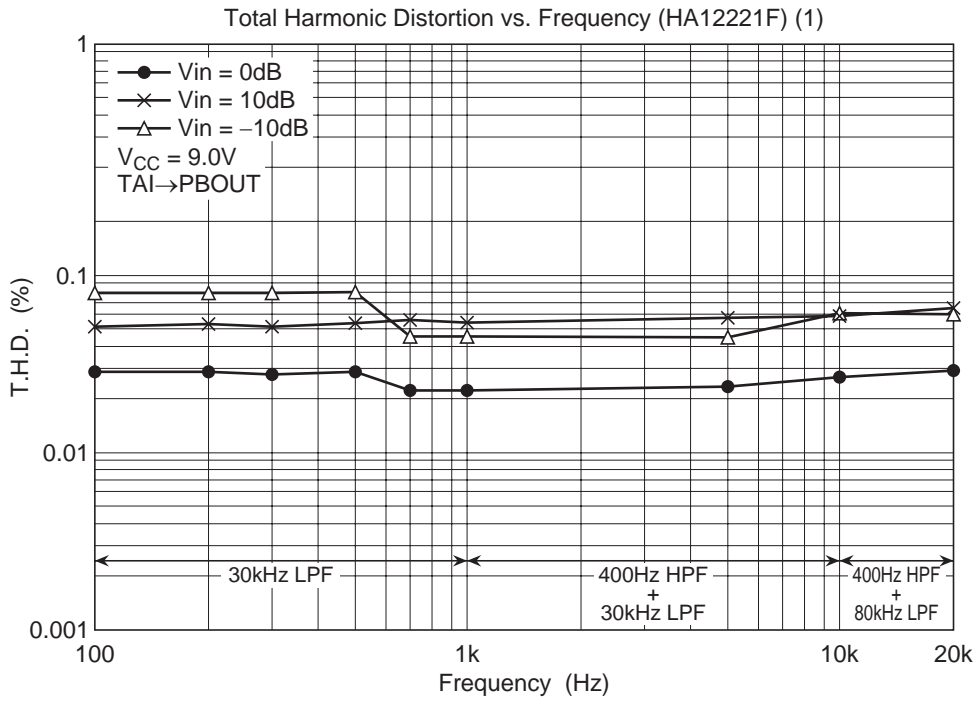

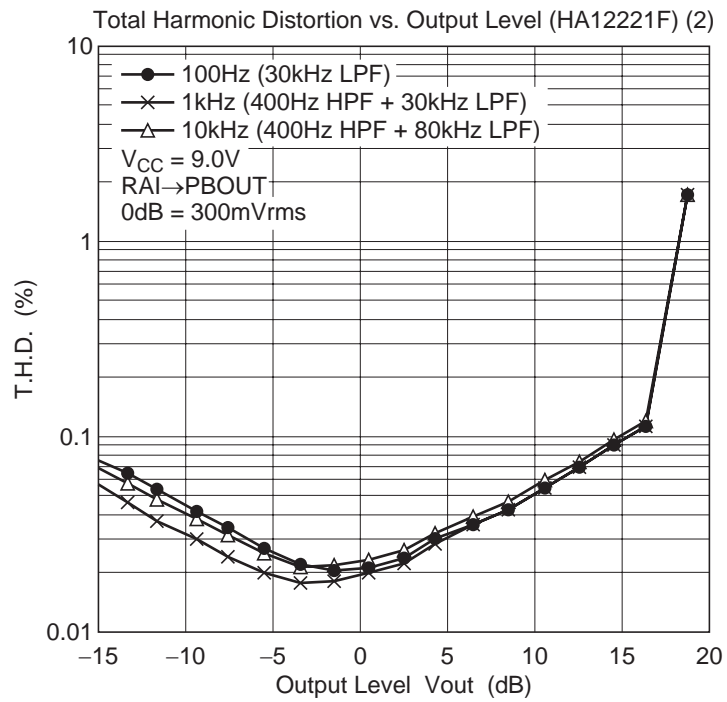
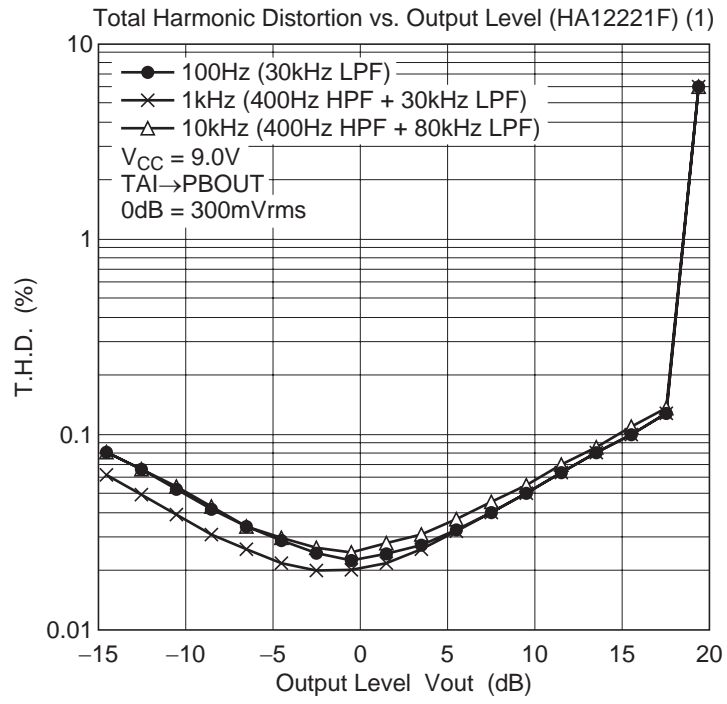

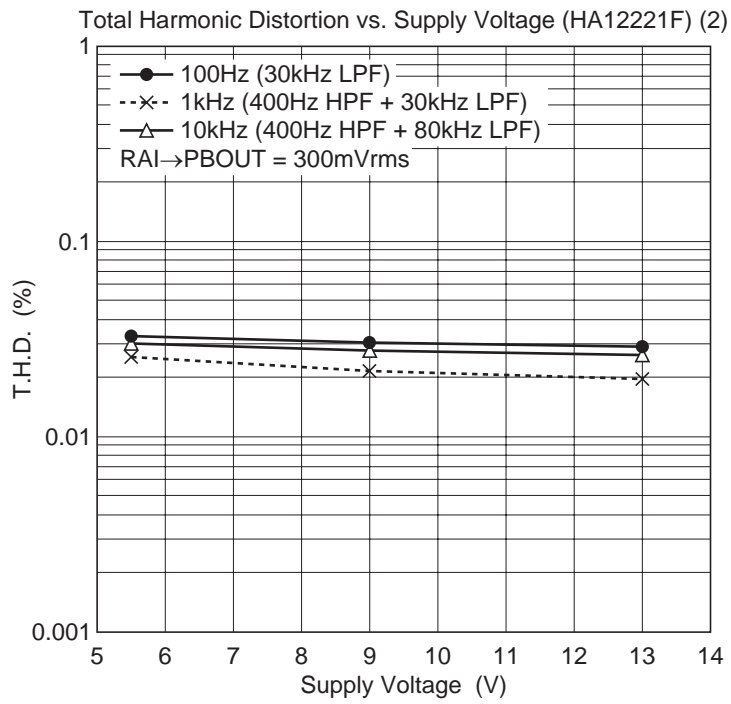
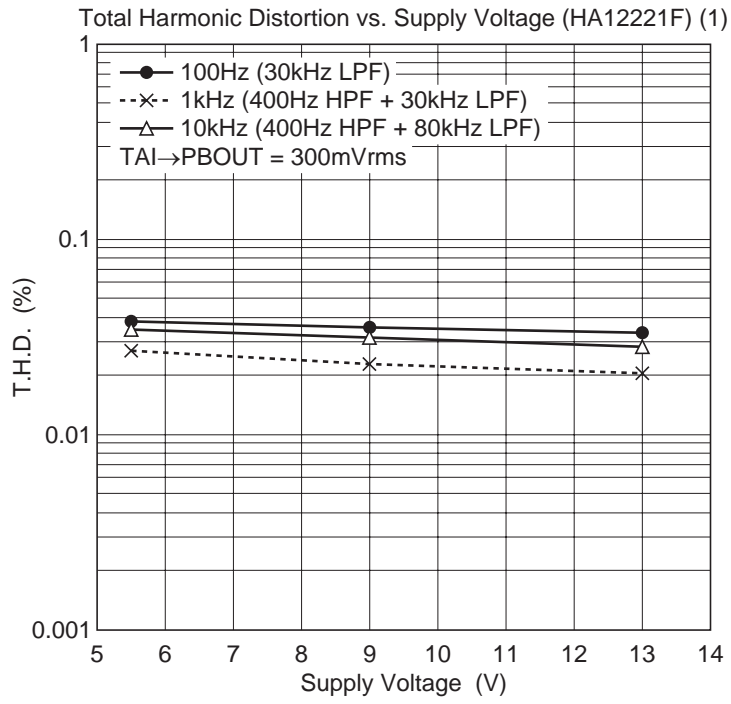

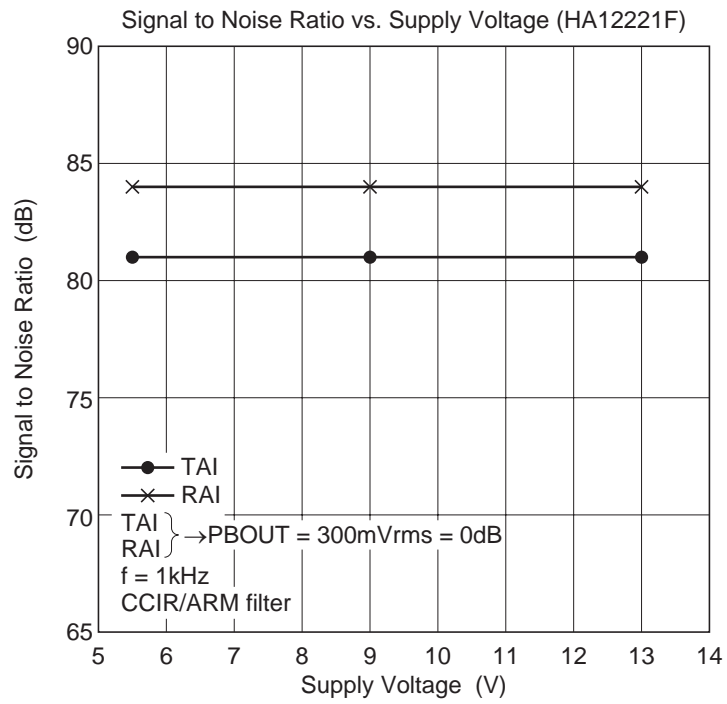
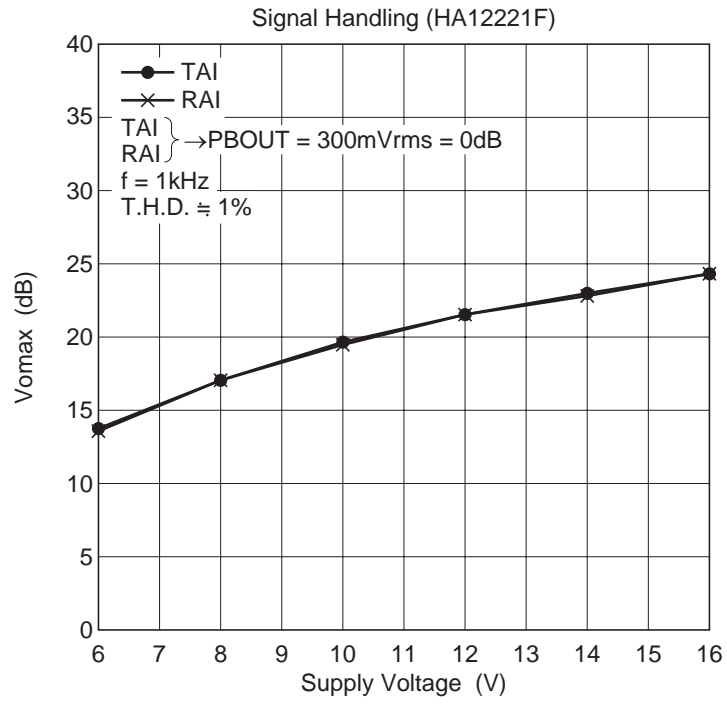

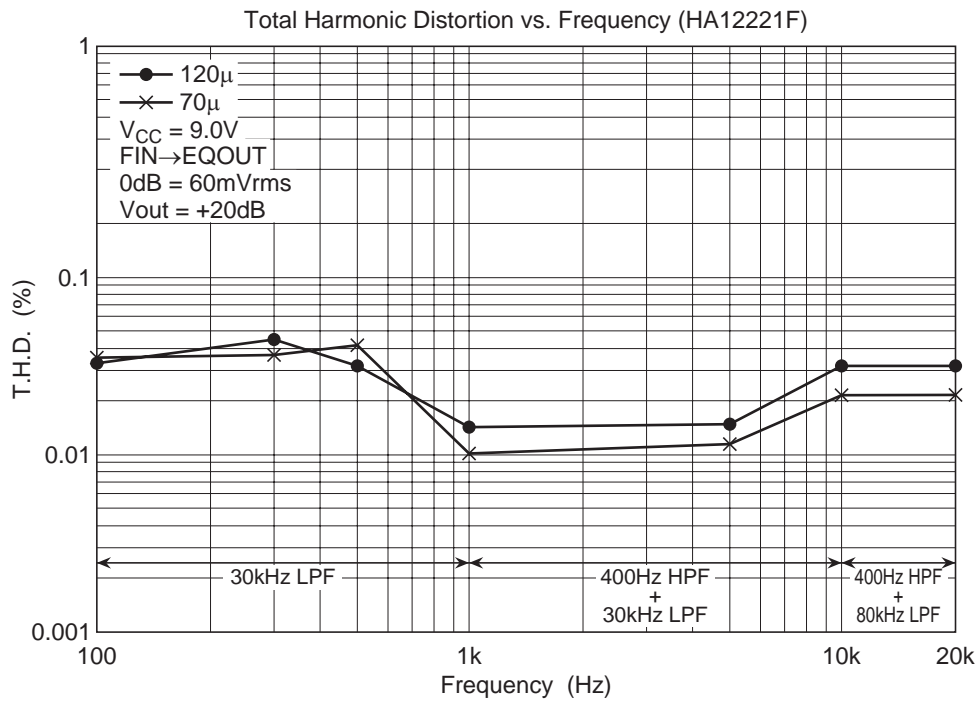
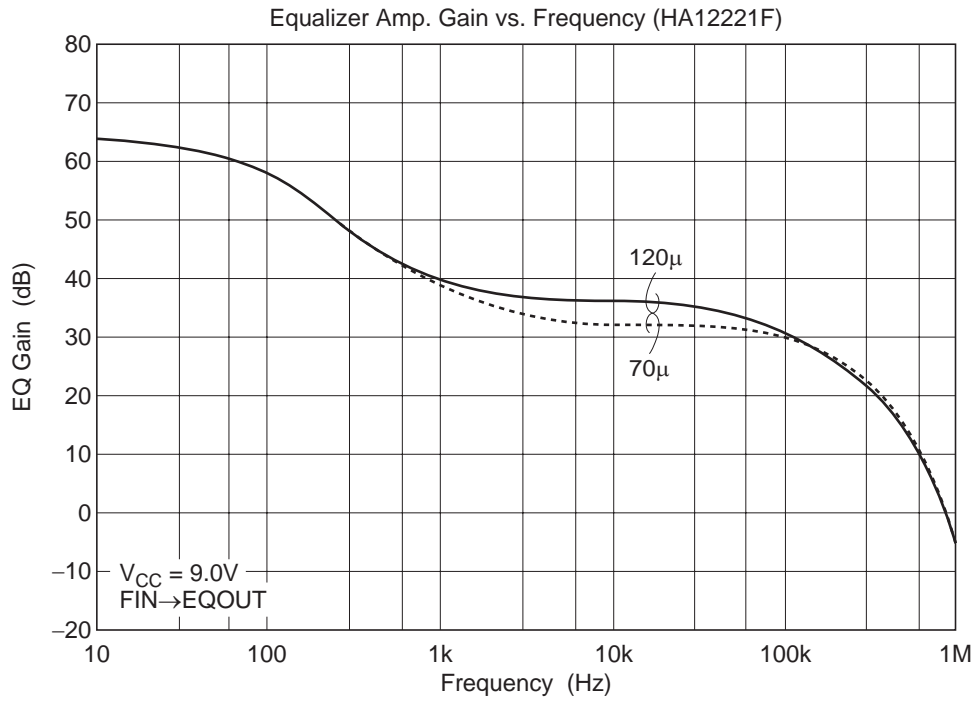

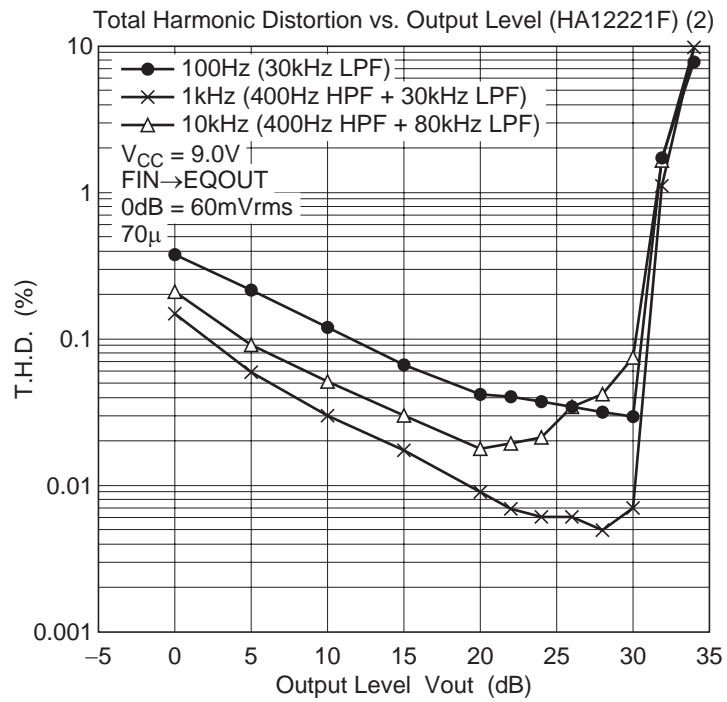
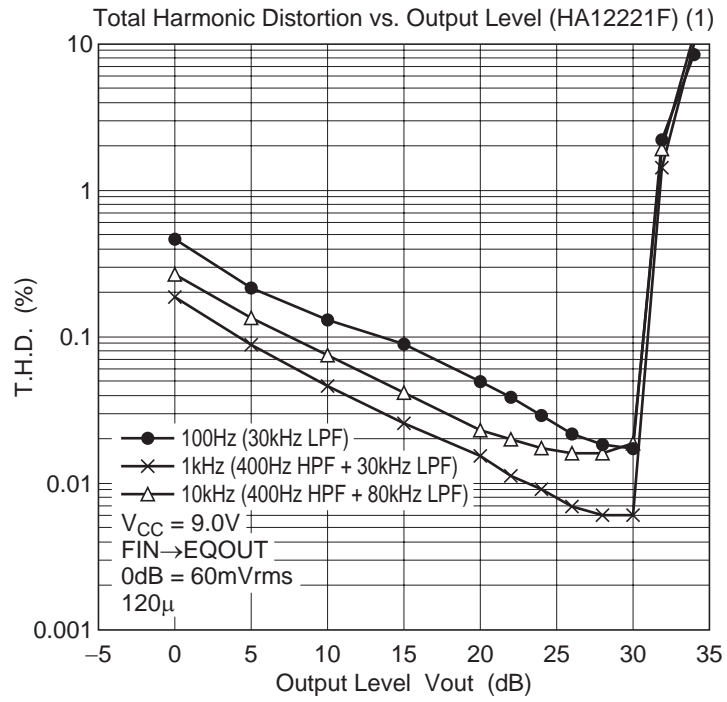

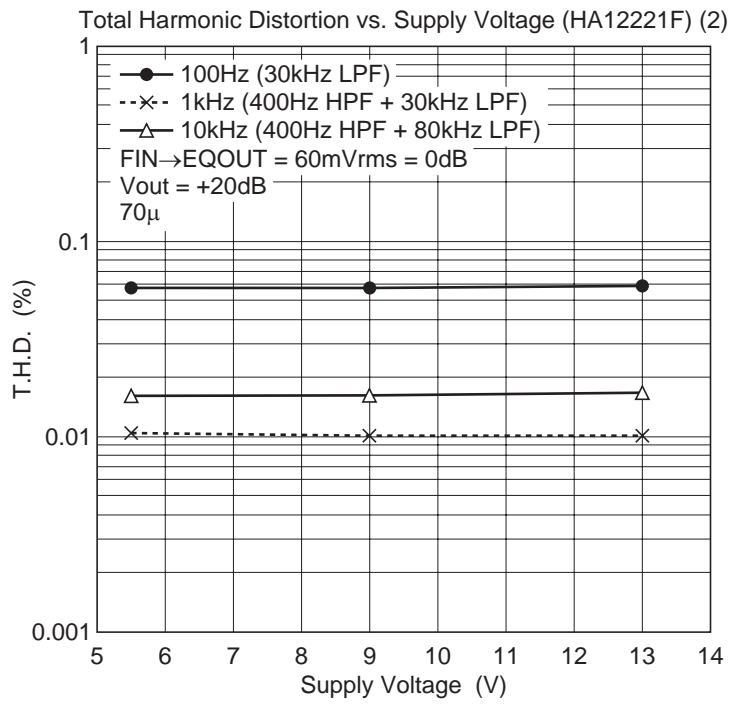
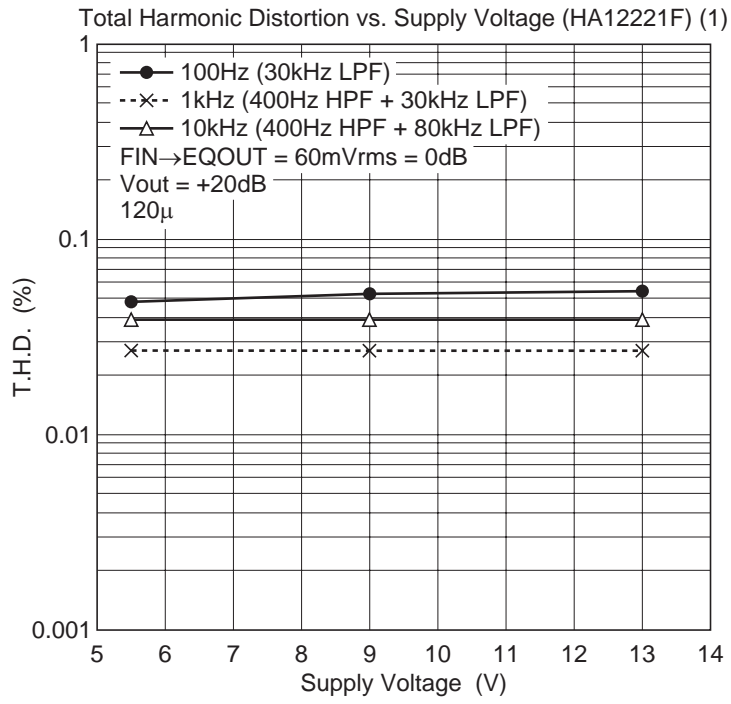

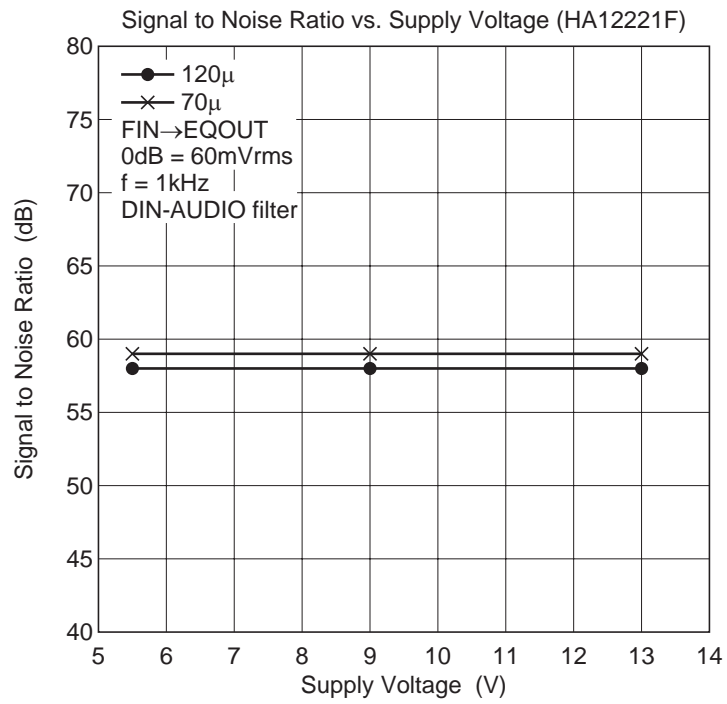
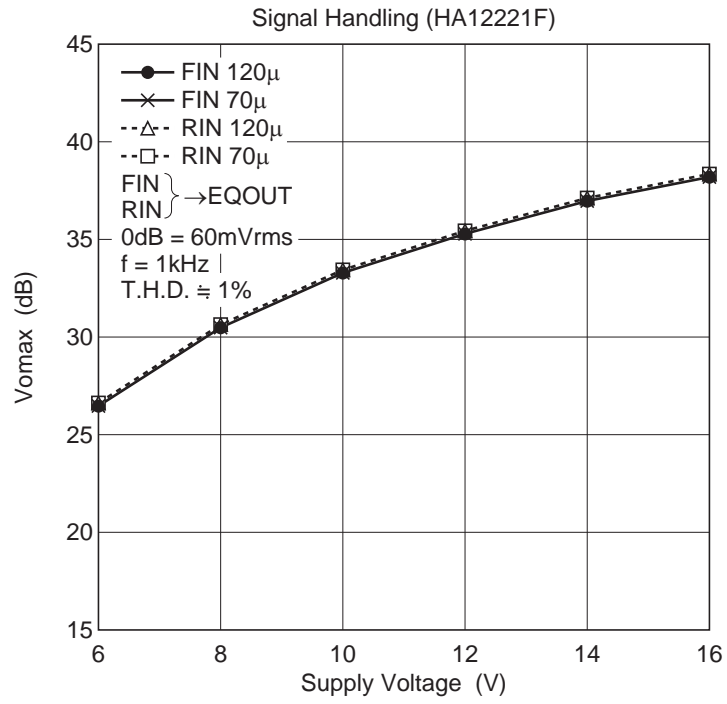

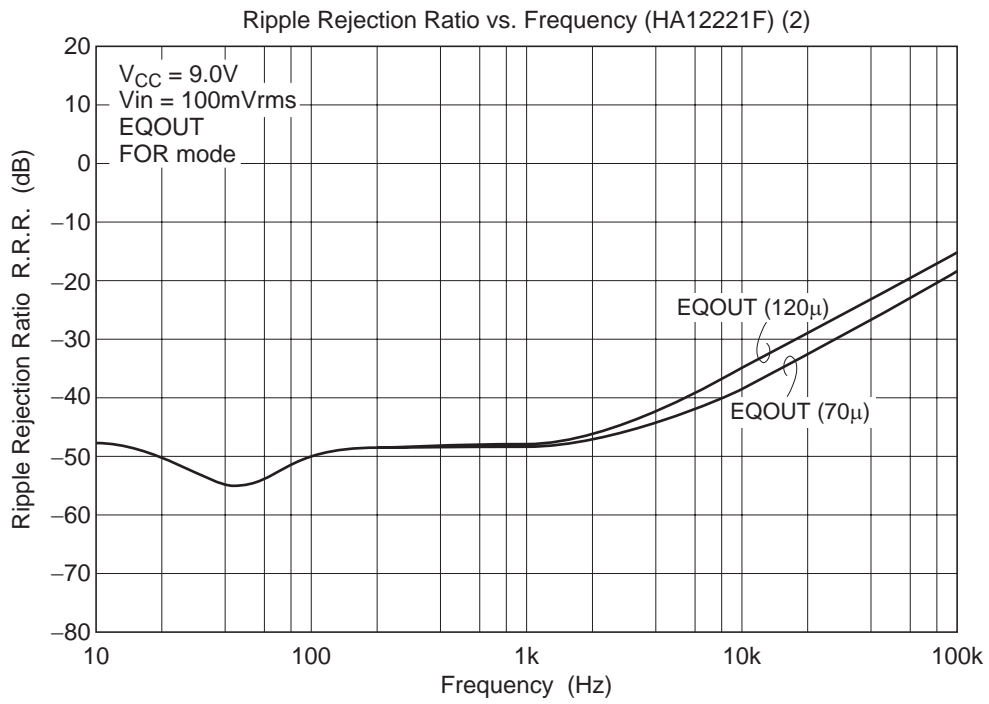
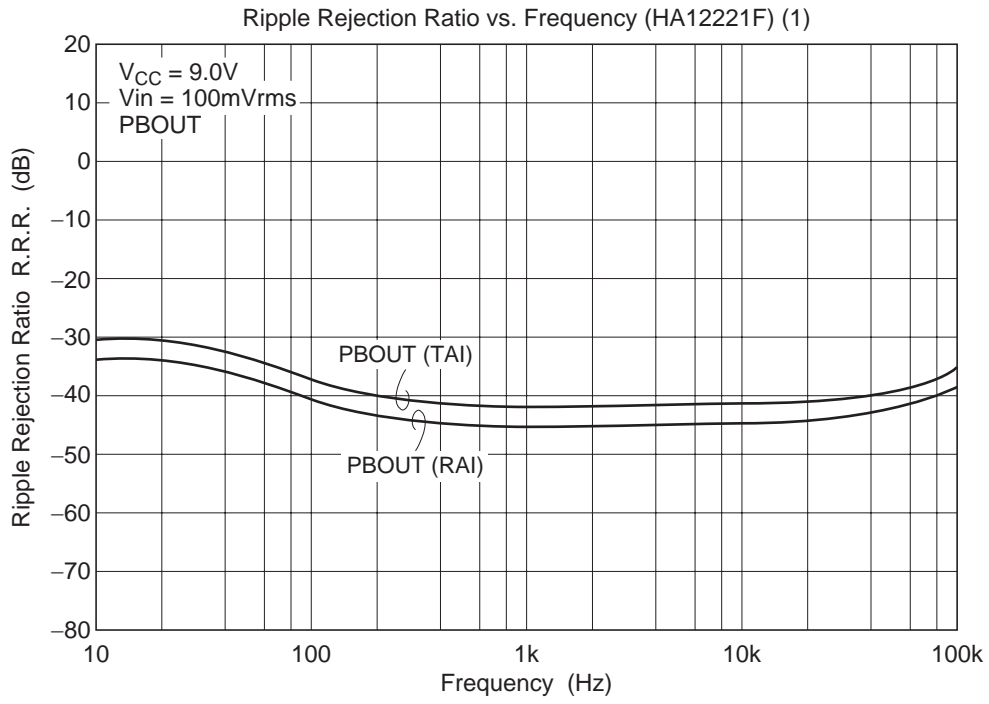

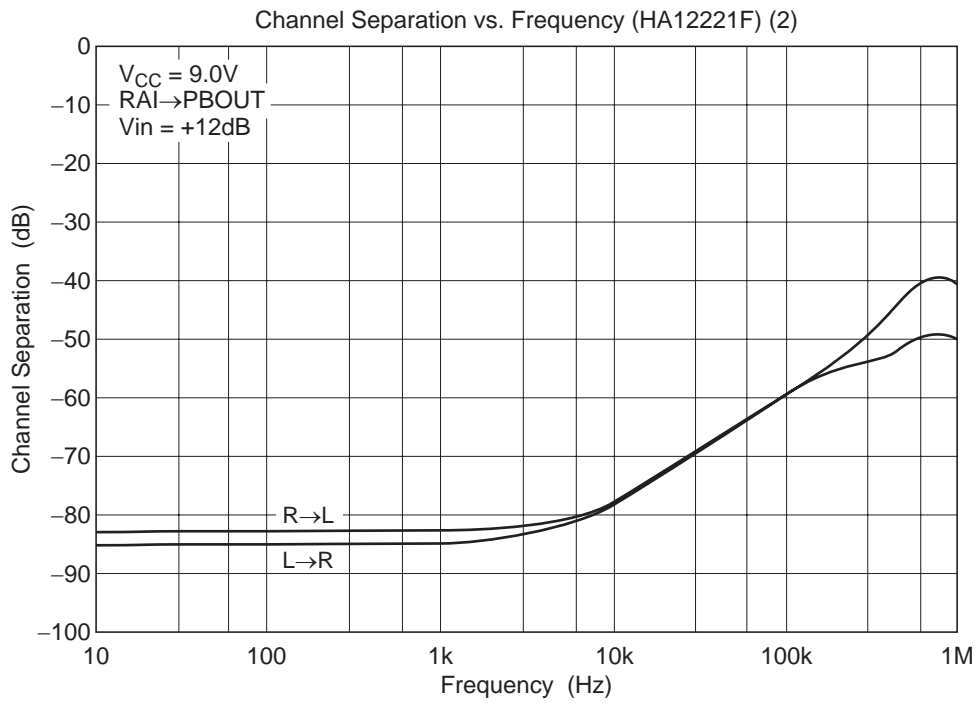
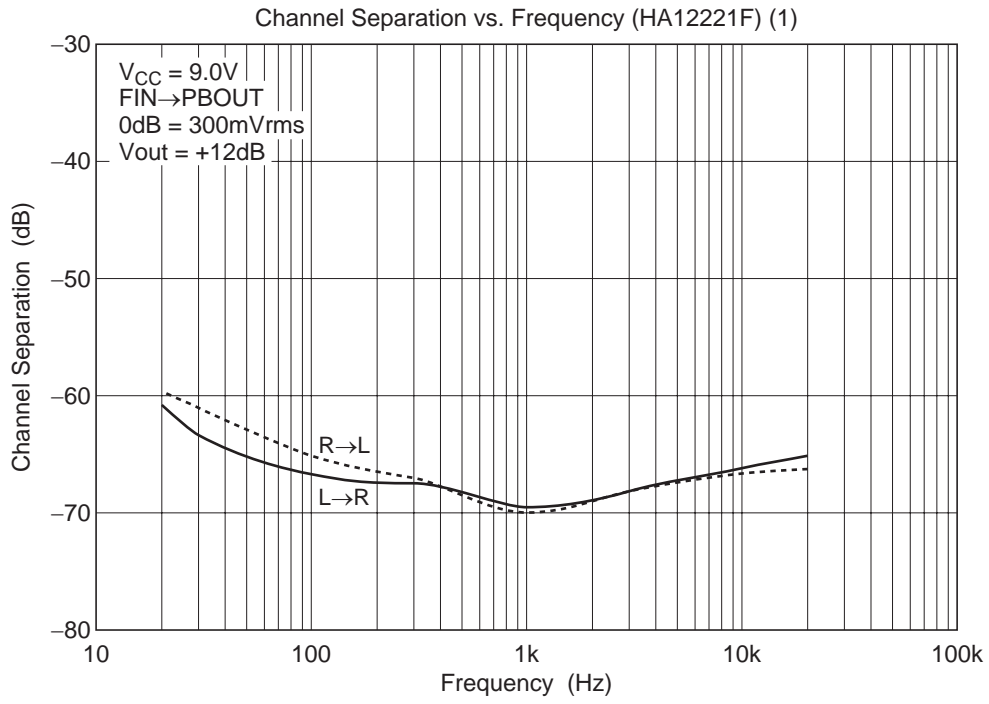

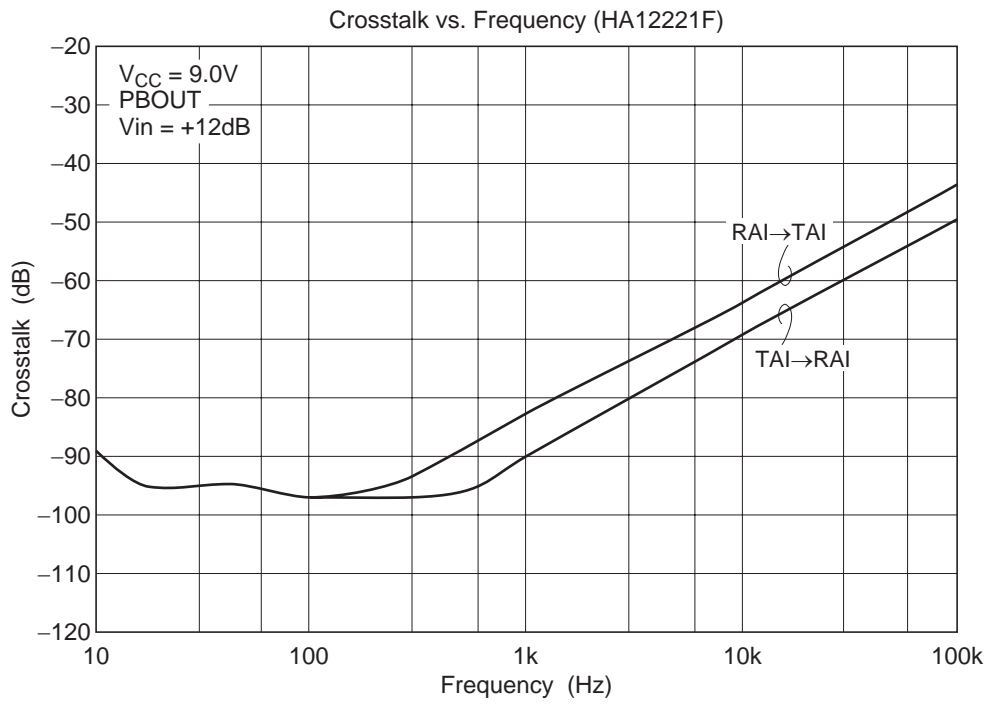
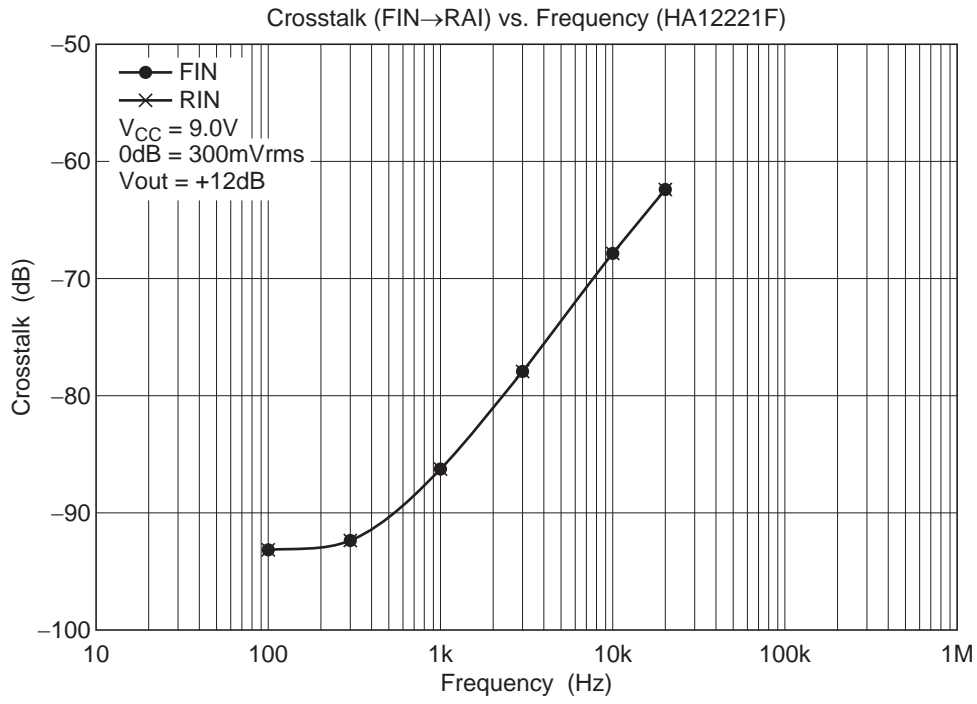

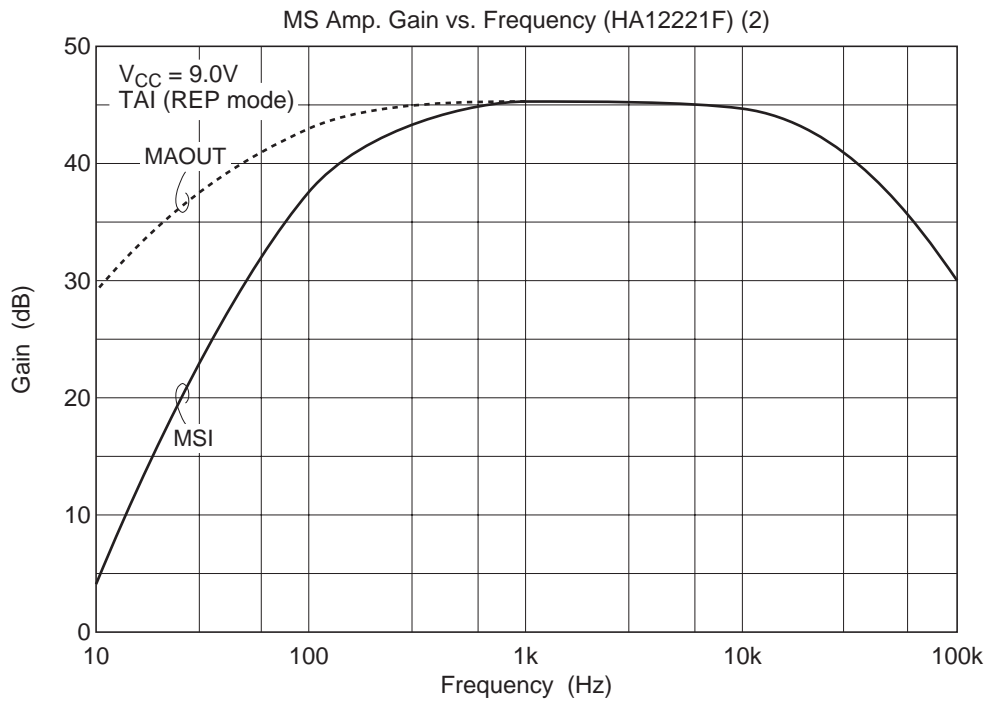
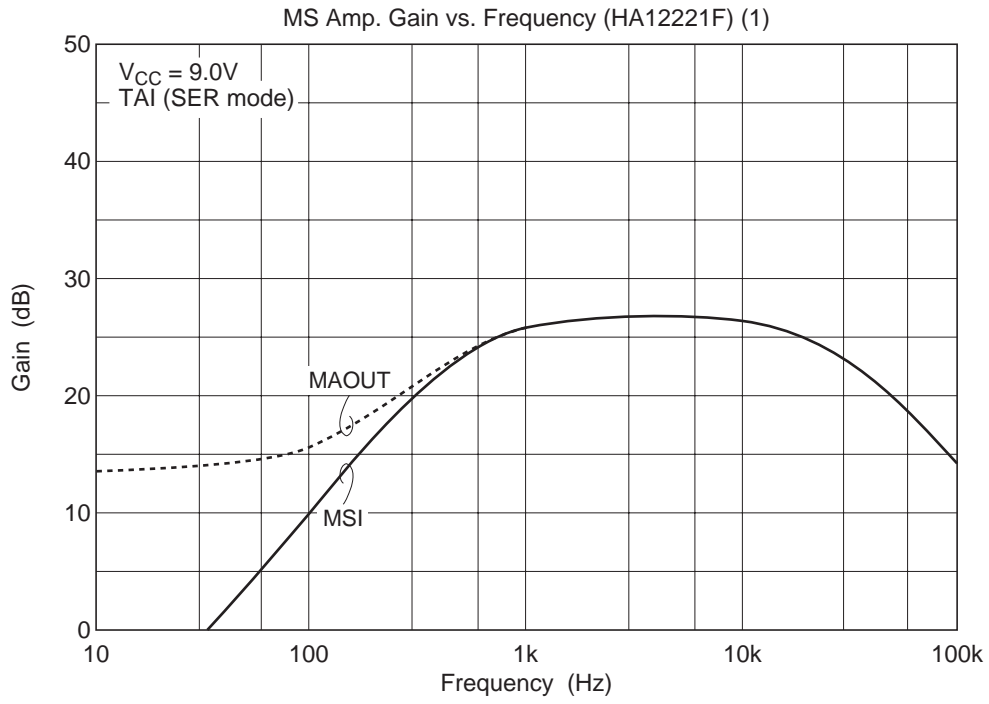

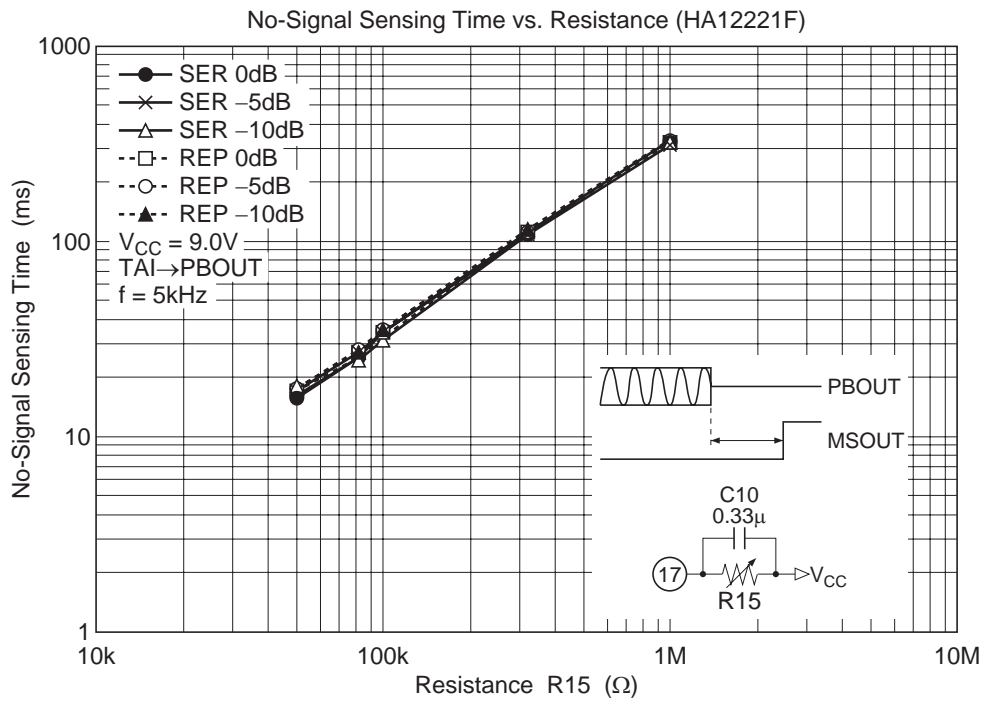
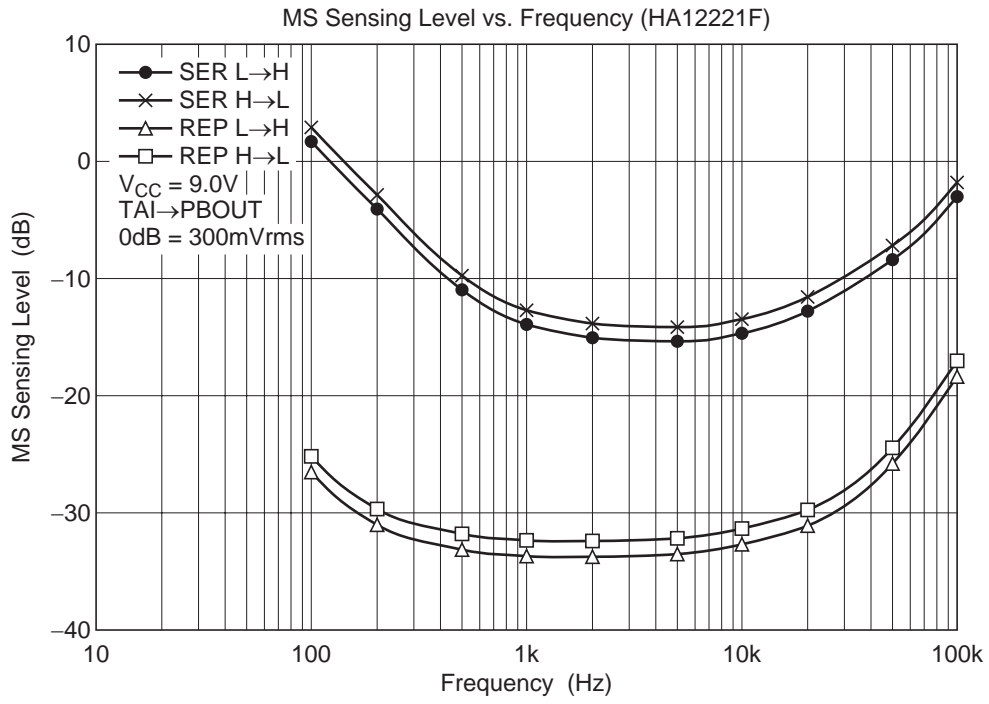

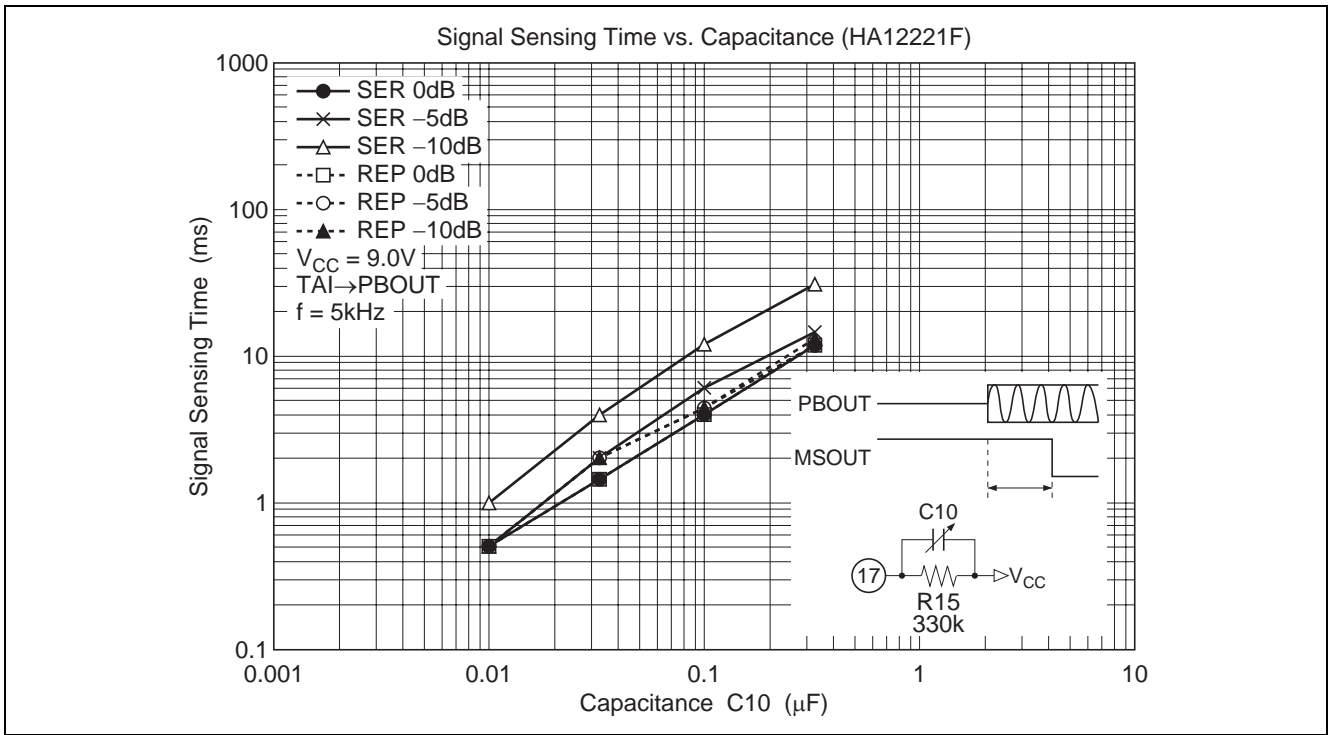

Package Dimensions

JEITA Package Code	RENESAS Code	Previous Code	MASS[Typ.]
P-LQFP40-7x7-0.65	PLQP0040JB-A	FP-40B	0.2g

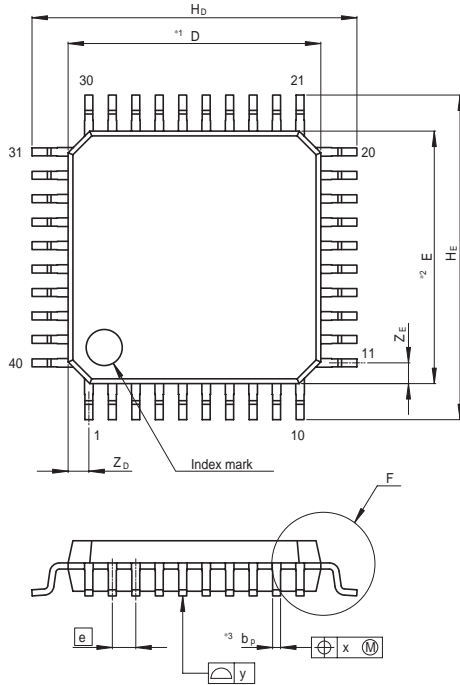

NOTE)
 1. DIMENSIONS*1*AND*2*
 DO NOT INCLUDE MOLD FLASH
 2. DIMENSION*3*DOES NOT
 INCLUDE TRIM OFFSET.

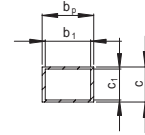

Terminal cross section

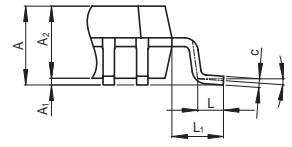

Detail F

Reference Symbol	Dimension in Millimeters		
	Min	Norm	Max
D	—	7.0	—
E	—	7.0	—
A ₂	—	1.40	—
H _D	8.8	9.0	9.2
H _E	8.8	9.0	9.2
A	—	—	1.70
A ₁	0.08	0.13	0.22
b _p	0.20	0.25	0.30
b ₁	—	0.22	—
c	0.12	0.17	0.22
c ₁	—	0.15	—
θ	0°	—	8°
e	—	0.65	—
x	—	—	0.13
y	—	—	0.10
Z _D	—	0.575	—
Z _E	—	0.575	—
L	0.40	0.50	0.60
L ₁	—	1.0	—

Renesas Technology Corp. Sales Strategic Planning Div. Nippon Bldg., 2-6-2, Ohte-machi, Chiyoda-ku, Tokyo 100-0004, Japan

Keep safety first in your circuit designs!

1. Renesas Technology Corp. puts the maximum effort into making semiconductor products better and more reliable, but there is always the possibility that trouble may occur with them. Trouble with semiconductors may lead to personal injury, fire or property damage.
Remember to give due consideration to safety when making your circuit designs, with appropriate measures such as (i) placement of substitutive, auxiliary circuits, (ii) use of nonflammable material or (iii) prevention against any malfunction or mishap.

Notes regarding these materials

1. These materials are intended as a reference to assist our customers in the selection of the Renesas Technology Corp. product best suited to the customer's application; they do not convey any license under any intellectual property rights, or any other rights, belonging to Renesas Technology Corp. or a third party.
 2. Renesas Technology Corp. assumes no responsibility for any damage, or infringement of any third-party's rights, originating in the use of any product data, diagrams, charts, programs, algorithms, or circuit application examples contained in these materials.
 3. All information contained in these materials, including product data, diagrams, charts, programs and algorithms represents information on products at the time of publication of these materials, and are subject to change by Renesas Technology Corp. without notice due to product improvements or other reasons. It is therefore recommended that customers contact Renesas Technology Corp. or an authorized Renesas Technology Corp. product distributor for the latest product information before purchasing a product listed herein.
The information described here may contain technical inaccuracies or typographical errors.
Renesas Technology Corp. assumes no responsibility for any damage, liability, or other loss rising from these inaccuracies or errors.
Please also pay attention to information published by Renesas Technology Corp. by various means, including the Renesas Technology Corp. Semiconductor home page (<http://www.renesas.com>).
 4. When using any or all of the information contained in these materials, including product data, diagrams, charts, programs, and algorithms, please be sure to evaluate all information as a total system before making a final decision on the applicability of the information and products. Renesas Technology Corp. assumes no responsibility for any damage, liability or other loss resulting from the information contained herein.
 5. Renesas Technology Corp. semiconductors are not designed or manufactured for use in a device or system that is used under circumstances in which human life is potentially at stake. Please contact Renesas Technology Corp. or an authorized Renesas Technology Corp. product distributor when considering the use of a product contained herein for any specific purposes, such as apparatus or systems for transportation, vehicular, medical, aerospace, nuclear, or undersea repeater use.
 6. The prior written approval of Renesas Technology Corp. is necessary to reprint or reproduce in whole or in part these materials.
 7. If these products or technologies are subject to the Japanese export control restrictions, they must be exported under a license from the Japanese government and cannot be imported into a country other than the approved destination.
Any diversion or reexport contrary to the export control laws and regulations of Japan and/or the country of destination is prohibited.
 8. Please contact Renesas Technology Corp. for further details on these materials or the products contained therein.
-



RENESAS SALES OFFICES

<http://www.renesas.com>

Refer to "<http://www.renesas.com/en/network>" for the latest and detailed information.

Renesas Technology America, Inc.

450 Holger Way, San Jose, CA 95134-1368, U.S.A
Tel: <1> (408) 382-7500, Fax: <1> (408) 382-7501

Renesas Technology Europe Limited

Dukes Meadow, Millboard Road, Bourne End, Buckinghamshire, SL8 5FH, U.K.
Tel: <44> (1628) 585-100, Fax: <44> (1628) 585-900

Renesas Technology Hong Kong Ltd.

7th Floor, North Tower, World Finance Centre, Harbour City, 1 Canton Road, Tsimshatsui, Kowloon, Hong Kong
Tel: <852> 2265-6688, Fax: <852> 2730-6071

Renesas Technology Taiwan Co., Ltd.

10th Floor, No.99, Fushing North Road, Taipei, Taiwan
Tel: <886> (2) 2715-2888, Fax: <886> (2) 2713-2999

Renesas Technology (Shanghai) Co., Ltd.

Unit2607 Ruijing Building, No.205 Maoming Road (S), Shanghai 200020, China
Tel: <86> (21) 6472-1001, Fax: <86> (21) 6415-2952

Renesas Technology Singapore Pte. Ltd.

1 Harbour Front Avenue, #06-10, Keppel Bay Tower, Singapore 098632
Tel: <65> 6213-0200, Fax: <65> 6278-8001