HA12230NT

Audio Signal Processor for Cassette Deck

HITACHI

ADE-207-322E (Z)

6th Edition
Nov. 2000

Description

HA12230NT is silicon monolithic bipolar IC providing PB equalizer, REC equalizer system and each electronic control switch in one chip.

Functions

- PB equalizer × 2 channel
- REC equalizer × 2 channel
- MS use Mixing Amp.
- Each electronic control switch to change tape type and mute etc.
- REC mute
- REC head return switch
- Line Amp.
- Line mute

Features

- REC equalizer is very small number of external parts, built-in 2 types of frequency characteristics
- PB equalizer circuit built-in
- REC/PB are possible with TYPE I/II
- Controllable from direct micro-computer output
- Available to reduce substrate-area because of high integration and small external parts

HA12230NT

Pin Description, Equivalent Circuit

($V_{CC} = 12\text{ V}$, $T_a = 25^\circ\text{C}$, No signal, The value in the table show typical value.)

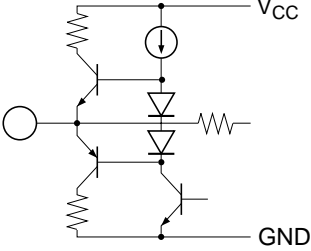
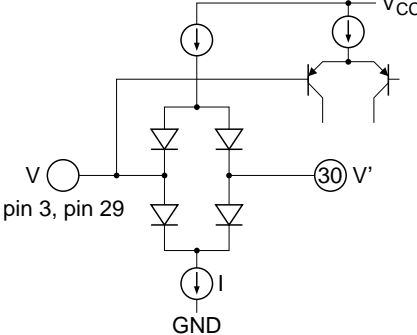
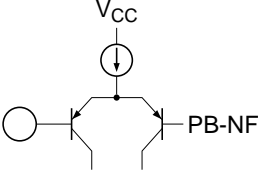
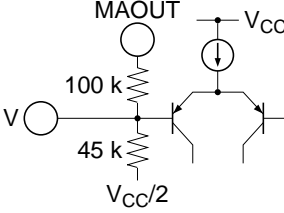
Pin No.	Pin Name	Note	Equivalent Circuit	Pin Description
17	V_{CC}	$V = V_{CC}$		V_{CC} pin
16	RECOUT(L)	$V = V_{CC}/2$		REC-EQ output
15	RECOUT(R)			MS Amp. output
10	MAOUT			Reference
1	VREF			
30	REC-RETURN	$V = V' = V_{CC}/2$		REC return
29	BIN(L)			PB B deck input
3	BIN(R)			
28	AIN(L)	$V = V_{CC}/2$		PB A deck input
4	AIN(R)			
11	MAI	$V = V_{CC}/2$		MS Amp. input

Pin Description, Equivalent Circuit

($V_{CC} = 12\text{ V}$, $T_a = 25^\circ\text{C}$, No signal, The value in the table show typical value.) (cont)

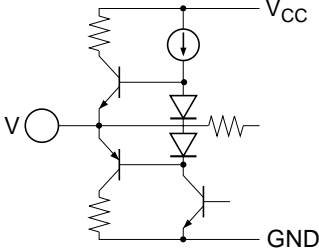
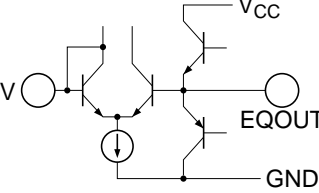
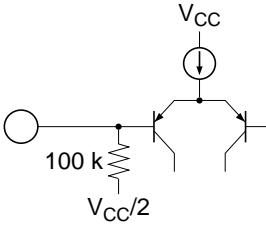
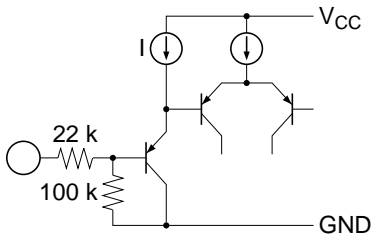
Pin No.	Pin Name	Note	Equivalent Circuit	Pin Description
23	PBOUT(L)	$V = V_{CC}/2$		PB output
9	PBOUT(R)			
25	EQOUT(L)			EQ output (120 μ)
7	EQOUT(R)			
26	PB-EQ(L)	$V = V_{CC}/2$		EQ output (70 μ)
6	PB-EQ(R)			
13	RECIN(R)	$V = V_{CC}/2$		REC-EQ input
18	RECIN(L)			
24	TAI(L)			Tape input
8	TAI(R)			
19	MUTE	$I = 20\ \mu\text{A}$		Mode control input
20	A $\overline{120/70}$			
21	A/ \overline{B}			
22	B $\overline{I/II}$			

HA12230NT

Pin Description, Equivalent Circuit

($V_{CC} = 12\text{ V}$, $T_a = 25^\circ\text{C}$, No signal, The value in the table show typical value.) (cont)

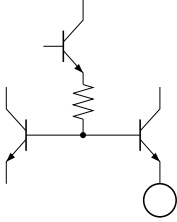
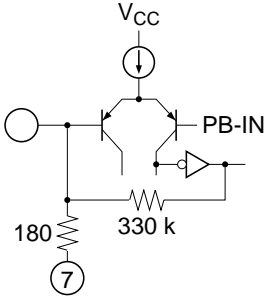
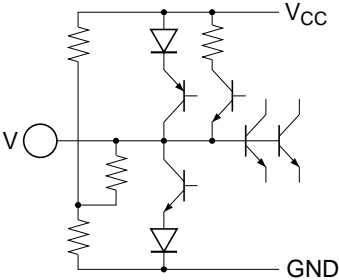
Pin No.	Pin Name	Note	Equivalent Circuit	Pin Description
12	IREF	$V = 1.2\text{ V}$		Equalizer reference current input
2	GND			GND pin
27	PB-NF(L)	$PB-IN = V_{ref}$		PB EQ feed back
5	PB-NF(R)			
14	RIP	$PBOUT = V_{ref}$		NAB output

Block Diagram

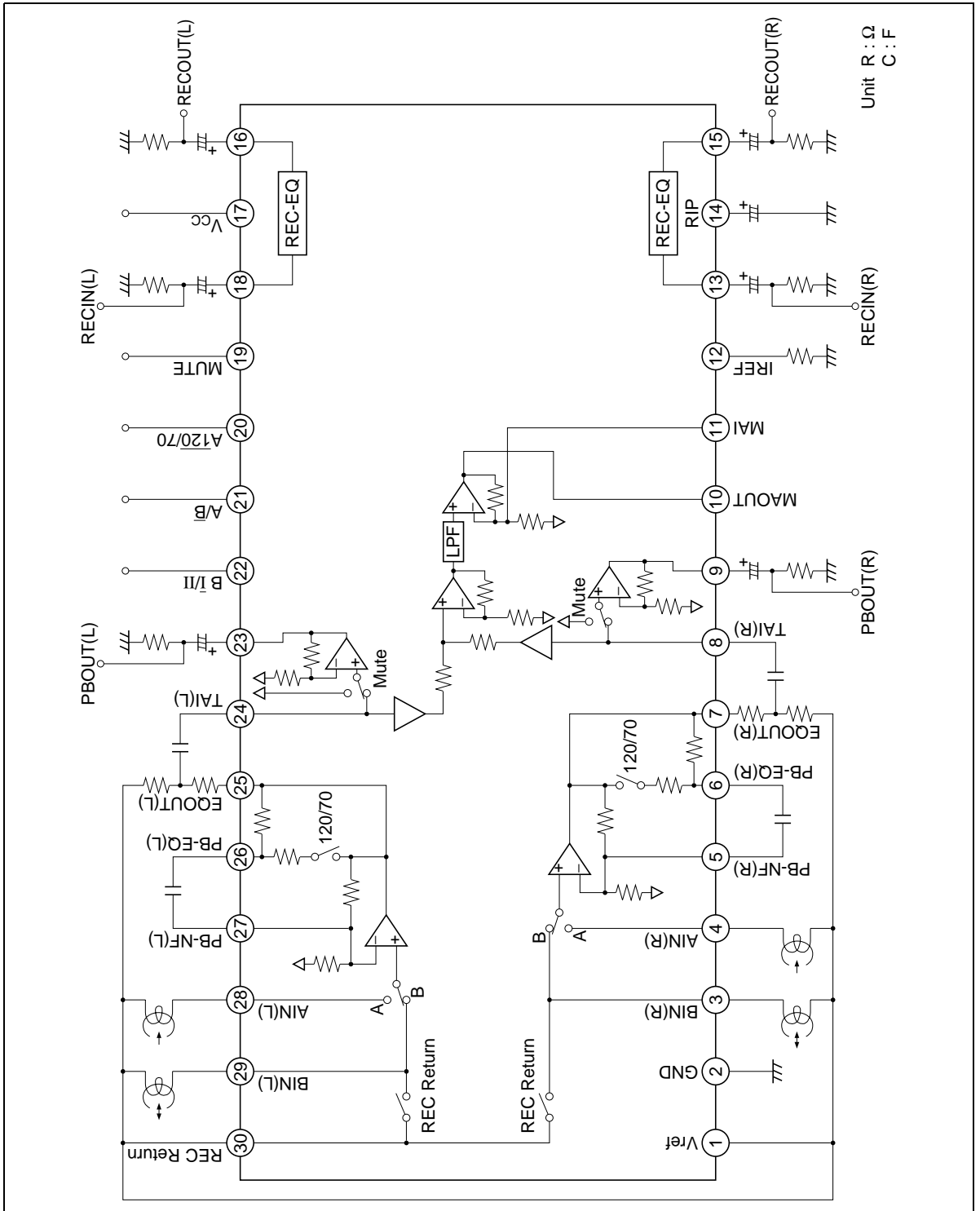

HA12230NT

Parallel Data Format

Pin No.	Pin Name	Lo	Mid	Hi
19	MUTE	MUTE OFF	—	MUTE ON
20	A $\overline{120/70}$	*	—	*
21	A/ \overline{B}	B Return SW OFF REC Mute ON	A Return SW ON REC Mute ON	A Return SW ON REC Mute OFF
22	B $\overline{I/II}$	REC-EQ * TYPE I	—	REC-EQ * TYPE II

Note: PB-EQ 120/70 logic

A $\overline{120/70}$	B $\overline{I/II}$	A/ \overline{B}		
		Lo	Mid	Hi
Low	Low	120 μ	120 μ	120 μ
Low	High	70 μ	120 μ	120 μ
High	Low	120 μ	70 μ	70 μ
High	High	70 μ	70 μ	70 μ

Functional Description

Power Supply Voltage Range

HA12230NT is designed to operate on single supply, shown by table 1.

Table 1 Operating Power Supply Voltage

Item	Power Supply Voltage Range
Single Supply	6.5 V to 15.0 V

Reference Voltage

These devices provide the reference voltage of half the supply voltage that is the signal grounds. As the peculiarity of these devices, the capacitor for the ripple filter is very small about 1/100 compared with their usual value. The block diagram is shown as figure 1.

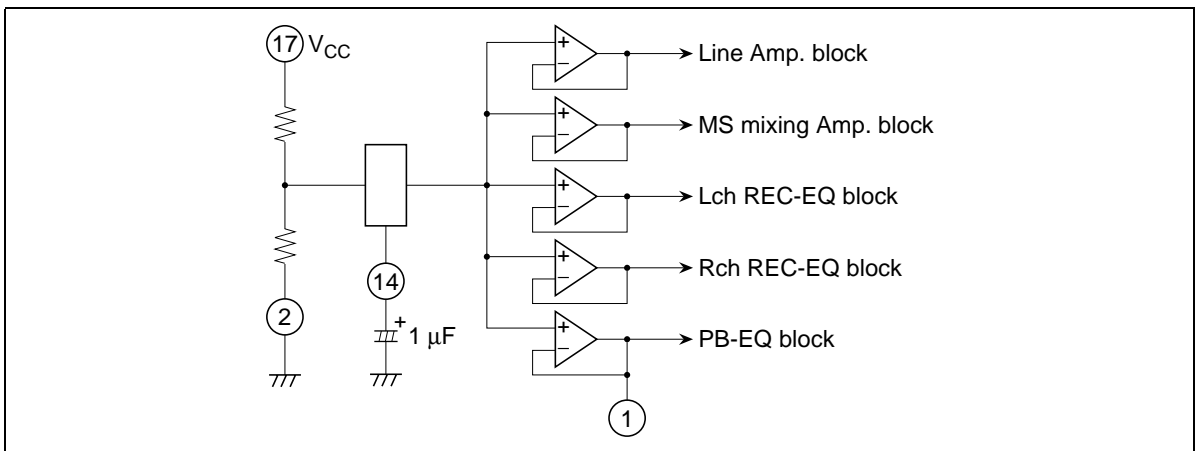

Figure 1 The Block Diagram of Reference Supply Voltage

HA12230NT

Operating Mode Control

HA12230NT provide fully electronic switching circuits. And each operating mode control is controlled by parallel data (DC voltage).

Table 2 Threshold Voltage (Vth)

Pin No.	Lo	Mid	Hi	Unit	Test Condition
19, 20, 22	0.0 to 0.5	—	2.4 to V_{CC}	V	Input Pin Measure
21	0.0 to 0.5	1.2 to 1.8	2.4 to V_{CC}	V	

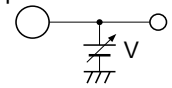

- Note:
1. Each pins are on pulled down with 100 k Ω internal resistor. Therefore, it will be low-level when each pins are open.
 2. Over shoot level and under shoot level of input signal must be the standardized.
(High: V_{CC} , Low: -0.2 V)

Block Diagram

Figure 2 shows the block diagram.

As this IC is built-in REC return switch, the configuration system can be simple system using a few external component and the REC/PB head.

About these logics, please look at the Parallel Data Format.

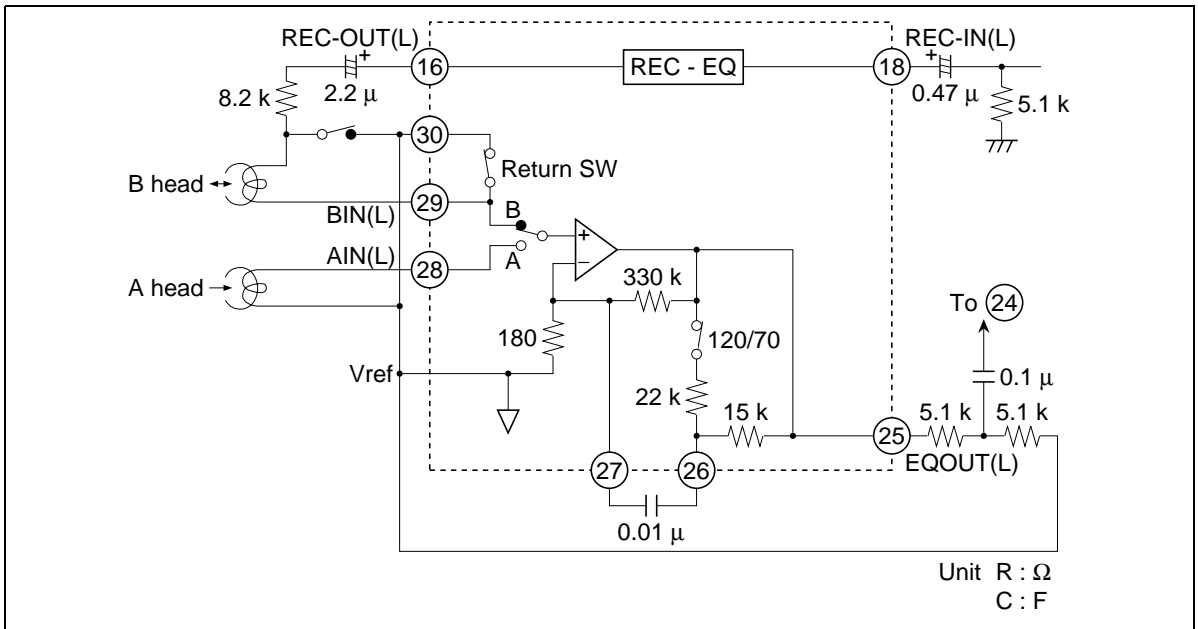

Figure 2 Block Diagram (Lch)

Level Diagram

The gain establishment of PB-EQ considers PB output level {(internal Line Amp. + PB Amp.) = 580 mV (Dolby Level)} like figure 3 at the target.

After replace RA and RB with a half-fix volume, adjust level.

Regarding REC-EQ adjust the gain in front of input to this IC.

The level diagram of 1 kHz is shown figure 3.

Similarly to PB, it consider Dolby level as a standard. And R1 needs the value more than 5.6 kΩ.

Because mode establishment resistances are built-in, REC-EQ frequency characteristics are respectively fixed value.

In case the change of the frequency characteristics are necessary, please inquire the responsible agent because the adjustment of resistors is necessary.

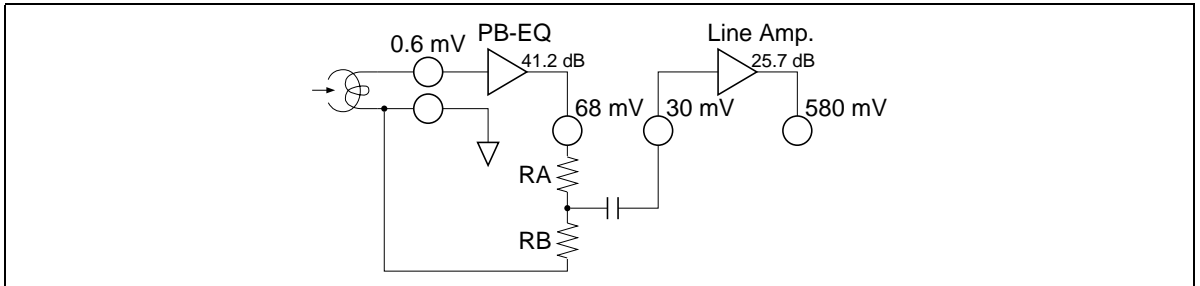

Figure 3 PB System Level Diagram

Line Mute

HA12230NT is built-in with mute circuit to Line Amp.

A mute control does with High/Low of pin 19.

Reducing pop noise is so much better 10 kΩ to 22 kΩ resistor to pin 19 in series and 1 μF to 22 μF capacitor.

A mute is not built-in when doing a power ON/OFF.

Please correspond to it, on the side of a set system.

Test Mode

Test mode becomes if it is resistor less than 10 kΩ of pin 12.

Please use resistor of 22 kΩ on the occasion of mount.

Music Sensor Mixing Block

- Gain with TAI to MAOUT

Case of one-side input, gain with TAI to MAOUT is attenuations 6 dB.

$$G_V = (L \cdot R \text{ signal addition circuit}) + (\text{MS Amp. gain}) + (\text{TAI one-side input attenuations})$$

$$= 20 + 20 \log \frac{100 \text{ k} + 45 \text{ k}}{45 \text{ k}} + (-6)$$

$$\approx 24.2 \text{ (dB)}$$

For a necessary case, please in series add CR to MAI terminal for gain regulation.

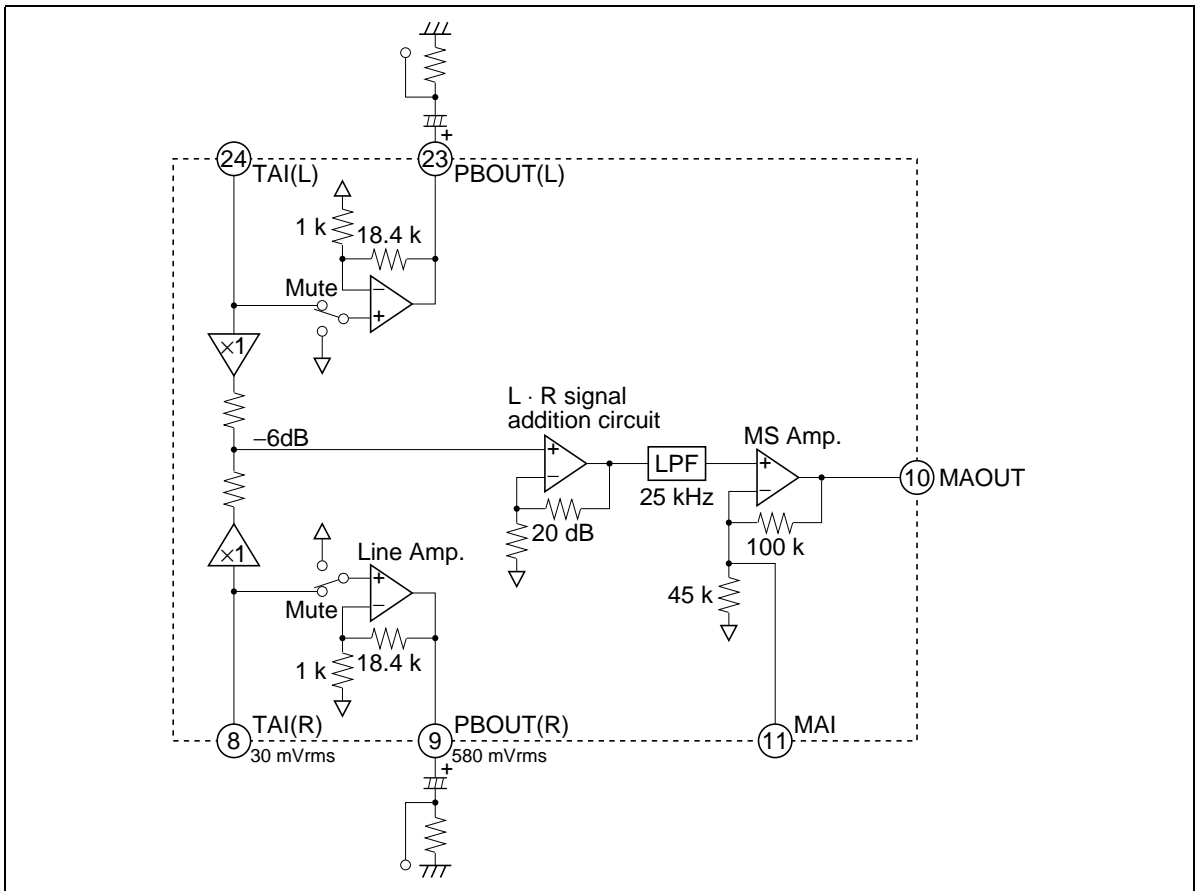

Figure 4 Music Sensor Mixing Amp. Block Diagram

Absolute Maximum Ratings (Ta = 25°C)

Item	Symbol	Rating	Unit	Note
Maximum supply voltage	V _{cc} max	16	V	
Power dissipation	Pd	500	mW	Ta ≤ 75°C
Operating temperature	Topr	-40 to +75	°C	
Storage temperature	Tstg	-55 to +125	°C	
Operating voltage	Vopr	6.5 to 15	V	

Note: HA12230NT operates on single supply voltage.

Electrical Characteristics

(T_a = 25°C, V_{CC} = 12 V, PBIN Standard Level = 0.6 mVrms at 1 kHz, LineIN Standard Level = 30 mVrms, LineOUT Standard Level = 580 mVrms)

Item	Symbol	Test Condition										Specification				Application Terminal				Re-mark				
		IC Condition			Test Condition							Min		Typ		Max		Unit			Input		Output	
		A/B	I/II	A120/70	MUTE	fin (Hz)	Vin (mVrms)	Other	Min	Typ	Max	Unit	R	L	R	L	R	L	COM		Re-mark			
Quiescent current	I _Q	A	I	70	OFF	—	—	No signal	15.0	22.5	33.0	mA	—	—	—	—	—	—	17	—				
Logical threshold	V _{IL}	—	—	—	—	—	—	—	—	—	—	—	—	—	—	—	—	—	19-22	—				
	V _{IM}	—	—	—	—	—	—	—	—	—	—	—	—	—	—	—	—	—	21	—				
	V _{IH}	—	—	—	—	—	—	—	—	—	—	—	—	—	—	—	—	—	19-22	—				
PB-REC crosstalk	CT PB/REC(1)	A	I	120	OFF	1k	*1	REC-EQ → PB-EQ	50.0	60.0	—	dB	13	18	9	23	—	—	—	—				
	CT PB/REC(2)	A	I	120	OFF	1k	6.0	PB-EQ → REC-EQ	60.0	70.0	—	dB	4	28	15	16	—	—	—	—				
PB-EQ gain	G _V PB(1)	A/B	I	120	OFF	1k	0.6	—	38.2	41.2	44.2	dB	4/3	28/29	7	25	—	—	—	—				
	G _V PB(2)	A	I	120	OFF	10k	0.6	—	35.2	38.2	41.2	dB	4	28	7	25	—	—	—	—				
	G _V PB(3)	A	II	70	OFF	10k	0.6	—	31.0	34.0	37.0	dB	4	28	7	25	—	—	—	—				
PB-EQ maximum output level	Vomax PB	A/B	I	120	OFF	1k	—	THD = 1%	0.3	0.6	—	Vrms	4/3	28/29	7	25	—	—	—	*2				
PB-EQ THD	THD PB	A/B	I	120	OFF	1k	2.4	—	—	0.2	0.5	%	4/3	28/29	7	25	—	—	—	—				
PB-EQ noise voltage	VNI PB	A/B	I	120	OFF	—	—	Rg = 820Ω, DIN-AUDIO	—	90	180	μVrms	4/3	28/29	7	25	—	—	—	—				
PB-EQ channel separation	CT R/L(1)	A/B	I	120	OFF	1k	6.0	—	50.0	60.0	—	dB	4/3	28/29	9	23	—	—	—	—				
PB-EQ crosstalk	CT A/B	A/B	I	120	OFF	1k	6.0	—	60.0	70.0	—	dB	4/3	28/29	9	23	—	—	—	—				
Line AMP gain	G _V LA	A	I	120	OFF	1k	30.0	—	24.2	25.7	27.2	dB	8	24	9	23	—	—	—	—				
Line AMP THD	THD LA	A	I	120	OFF	1k	30.0	—	—	0.05	0.30	%	8	24	9	23	—	—	—	—				
Line AMP maximum output level	Vomax LA	A	I	120	OFF	1k	—	THD = 1%	1.16	1.40	—	Vrms	8	24	9	23	—	—	—	*2				
MS AMP gain	G _V MS	A	I	120	OFF	1k	30.0	—	22.7	24.2	25.7	dB	8	24	—	—	—	—	—	—				
Line MUTE attenuation	L-MUTE ATT	A	I	120	ON	1k	120.0	—	70.0	80.0	—	dB	8	24	9	23	—	—	—	—				

Notes: 1. Large level without clipping
2. V_{CC} = 6.5 V

Electrical Characteristics (cont)

(T_a = 25°C, V_{CC} = 12 V, EQIN Standard Level = -20 dBs = 77.5 mV/rms)

Item	Symbol	Test Condition										Specification				Application Terminal				Re-mark
		IC Condition					Other					Min	Typ	Max	Unit	Input		Output		
		A/B	B I/II	A120/70	MUTE	f _{in} (Hz)	V _{in} (mVrms)				R					L	R	L		
REC-EQ frequency characteristics TYPE I	G _V REC-NN1	A	I	120	OFF	1k	7.75				13.5	15.0	16.5	dB	13	18	15	16		
	G _V REC-NN2	A	I	120	OFF	5k	7.75			15.25	17.25	19.25	dB	13	18	15	16			
	G _V REC-NN3	A	I	120	OFF	12.5k	7.75			25.0	28.0	31.0	dB	13	18	15	16			
REC-EQ frequency characteristics TYPE II	G _V REC-NC1	A	II	120	OFF	1k	7.75			18.0	19.5	21.0	dB	13	18	15	16			
	G _V REC-NC2	A	II	120	OFF	5k	7.75			20.5	22.5	24.5	dB	13	18	15	16			
	G _V REC-NC3	A	II	120	OFF	12.5k	7.75			29.0	32.0	35.0	dB	13	18	15	16			
REC-EQ channel separation	CT R/L(2)	A	I	120	OFF	1k	*1			61.0	70.0	—	dB	13	18	15	16			
REC-MUTE attenuation	R-MUTE ATT	MID	I	120	OFF	1k	*1			66.0	76.0	—	dB	13	18	15	16			
REC-EQ maximum output level	V _{omax} REC	A	I	120	OFF	1k	—			0.7	1.0	—	Vrms	13	18	15	16	*2		
REC-EQ THD	THD REC	A	I	120	OFF	1k	77.5			—	0.2	0.5	%	13	18	15	16			
REC-EQ S/N	S/N REC	A	I	120	OFF	1k	—			56.0	59.0	—	dB	13	18	15	16			

Notes: 1. Large level without clipping
2. V_{CC} = 6.5 V

HA12230NT

Test Circuit

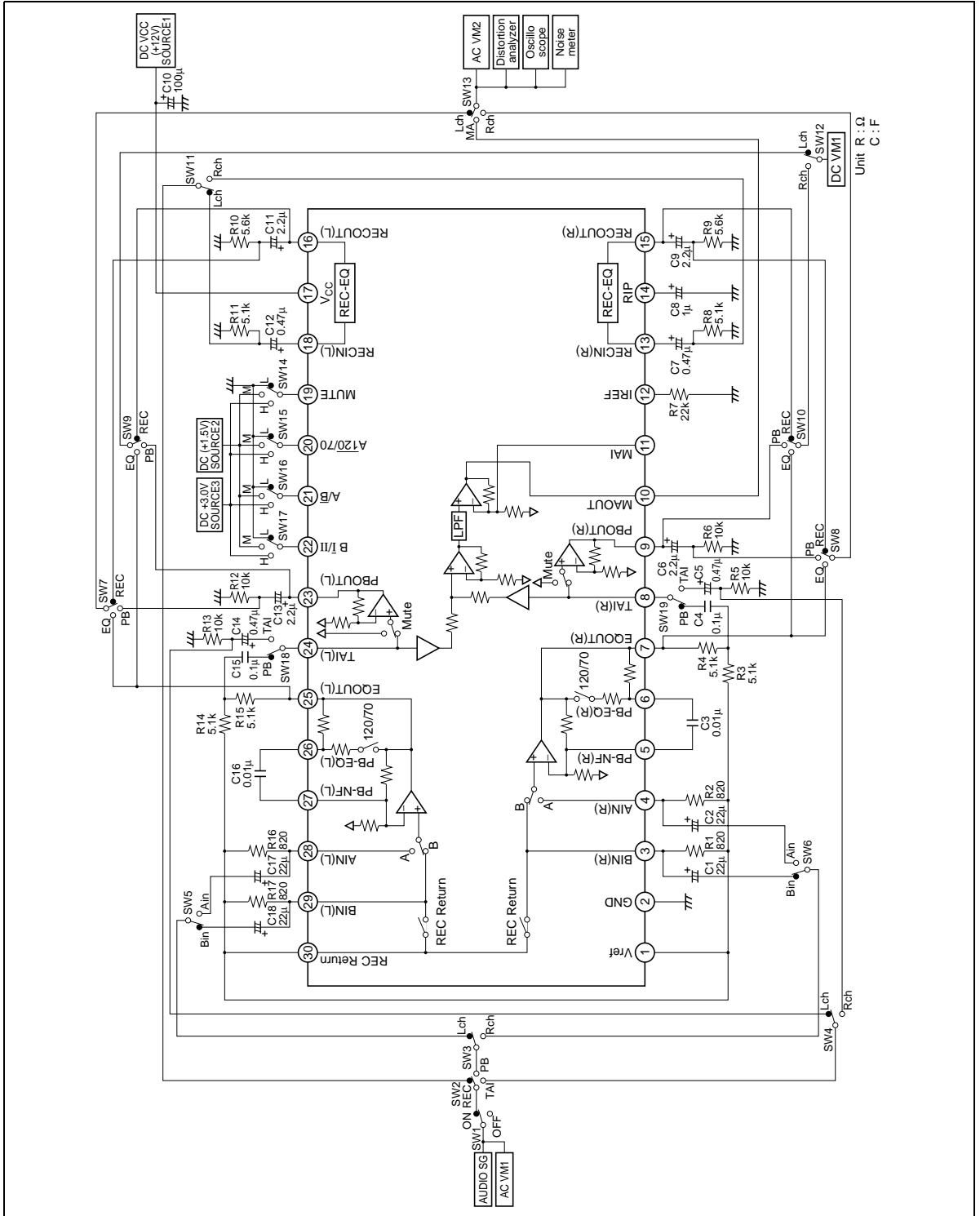

Characteristic Curves

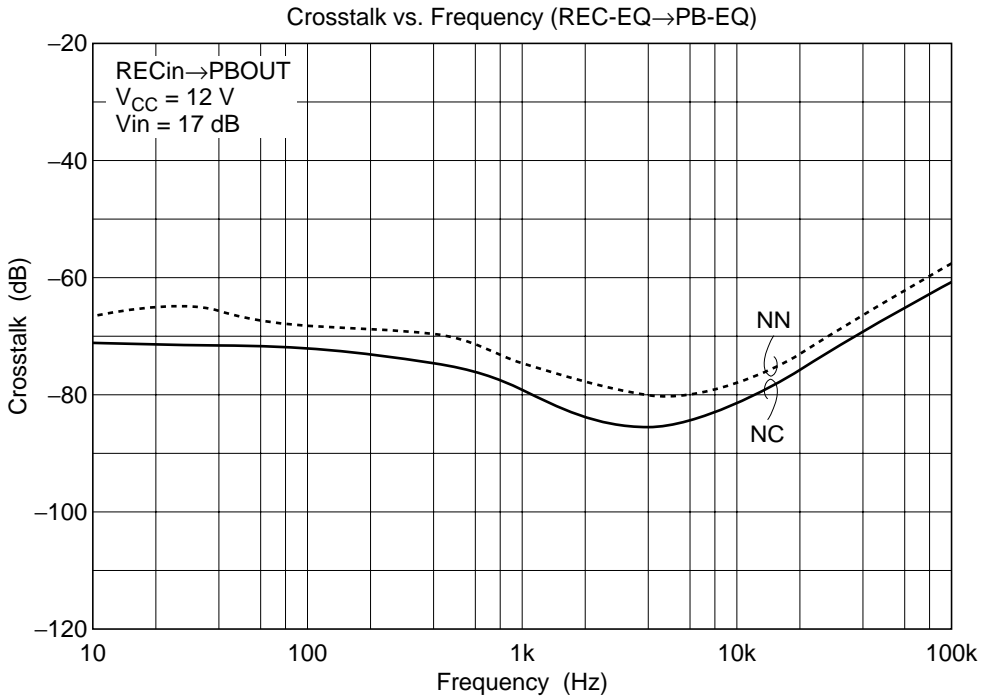
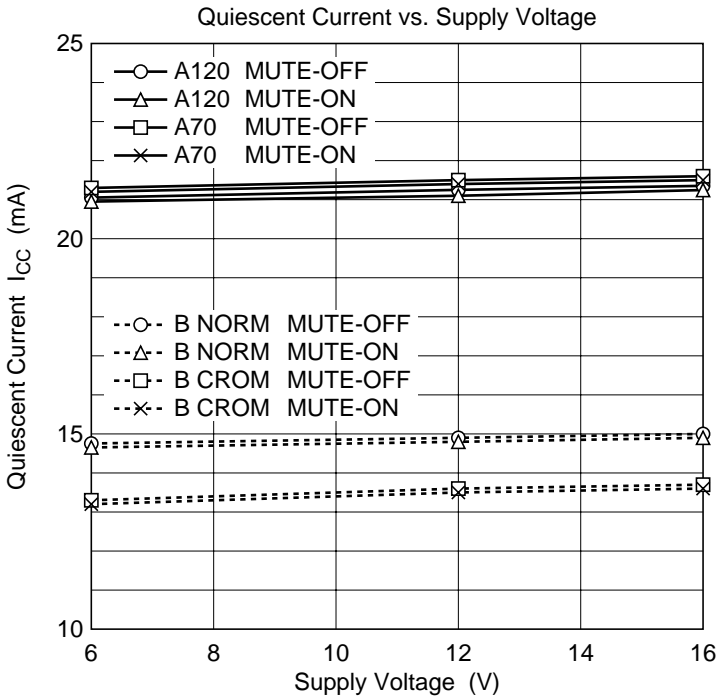

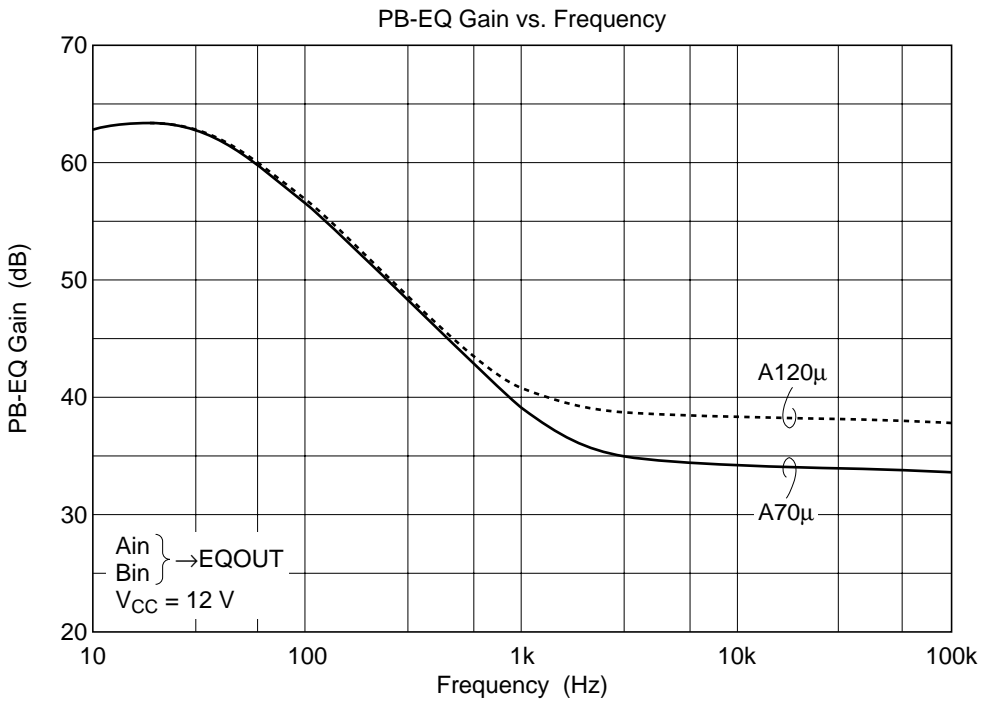
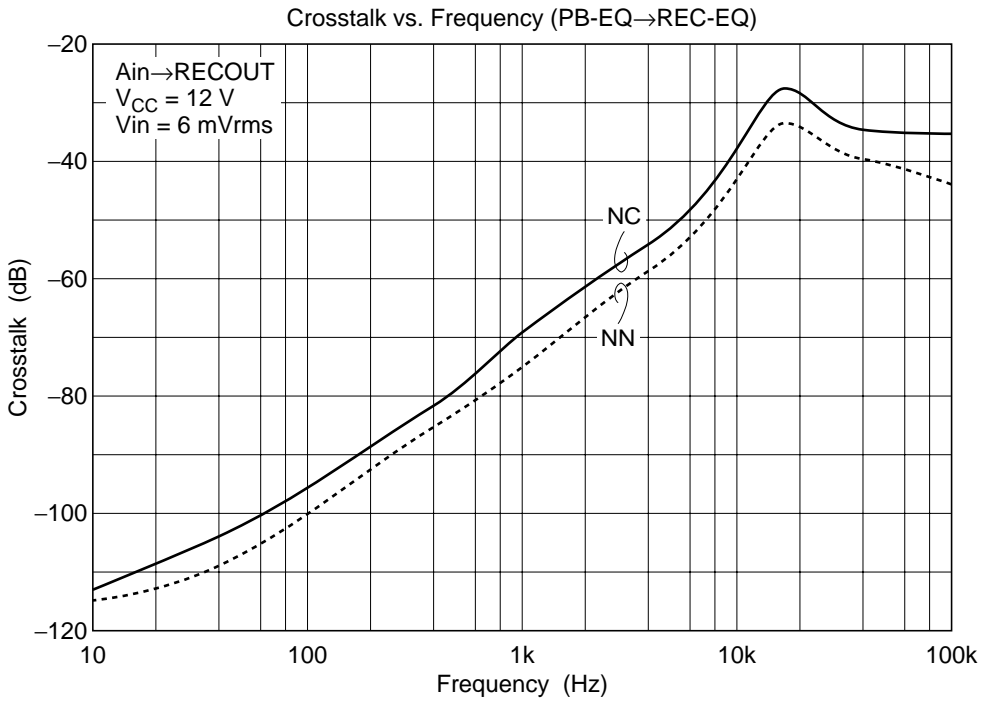

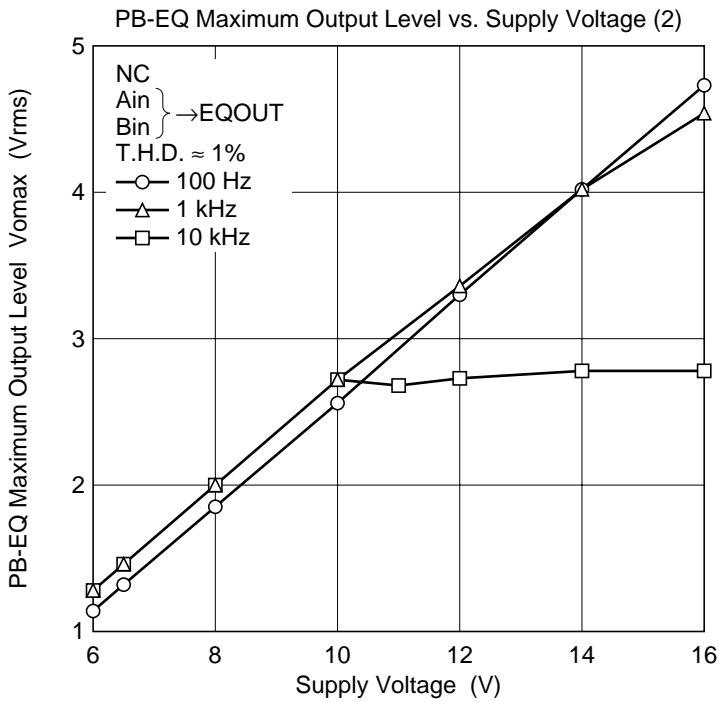
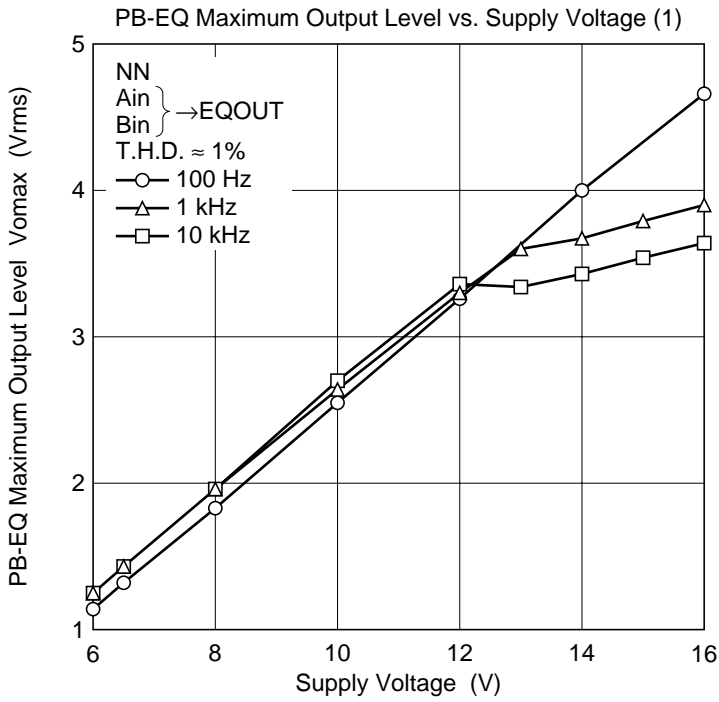

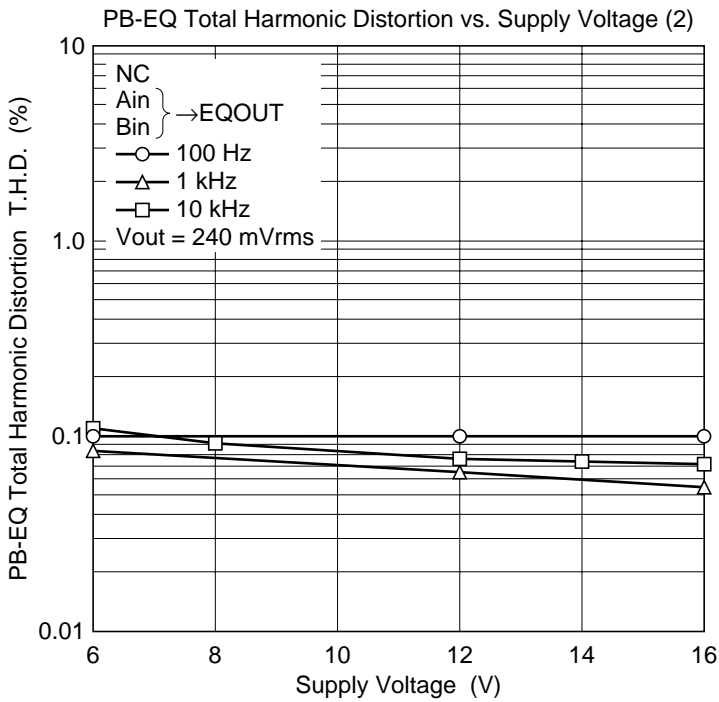
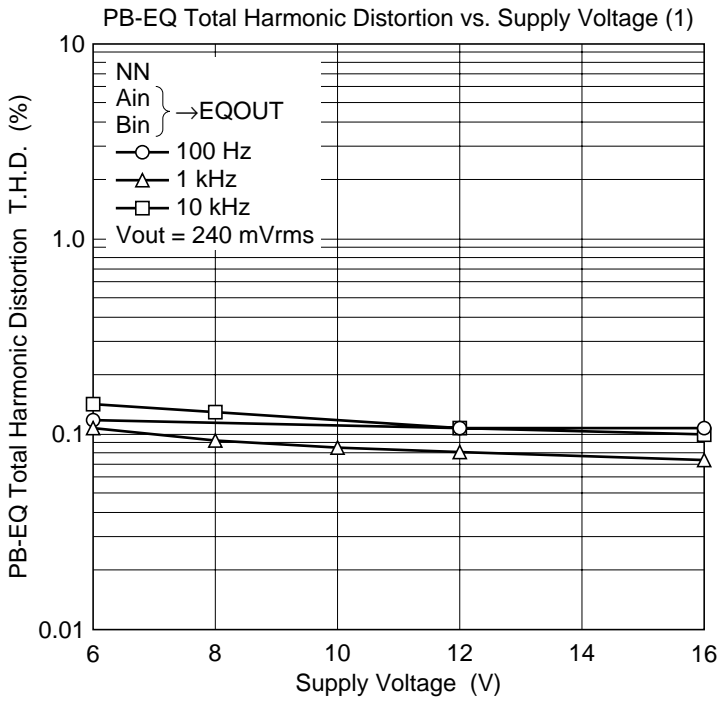

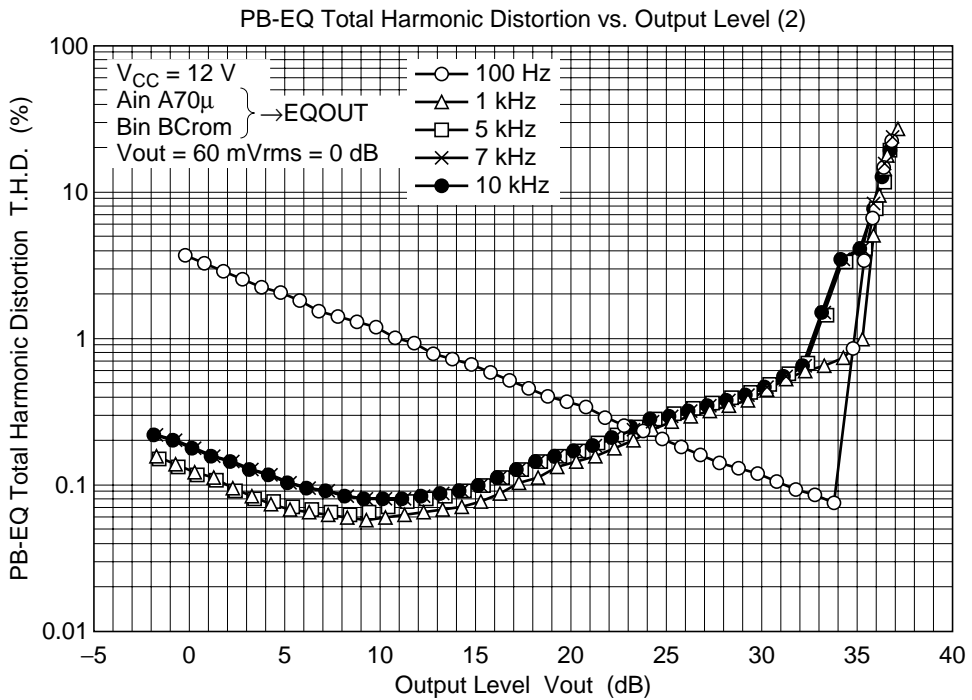
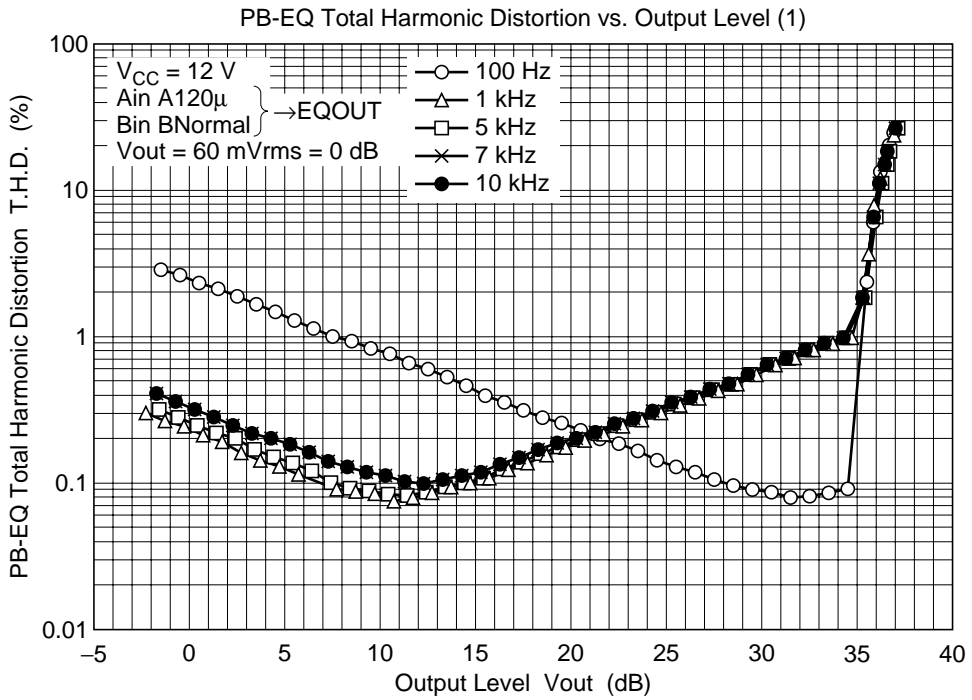

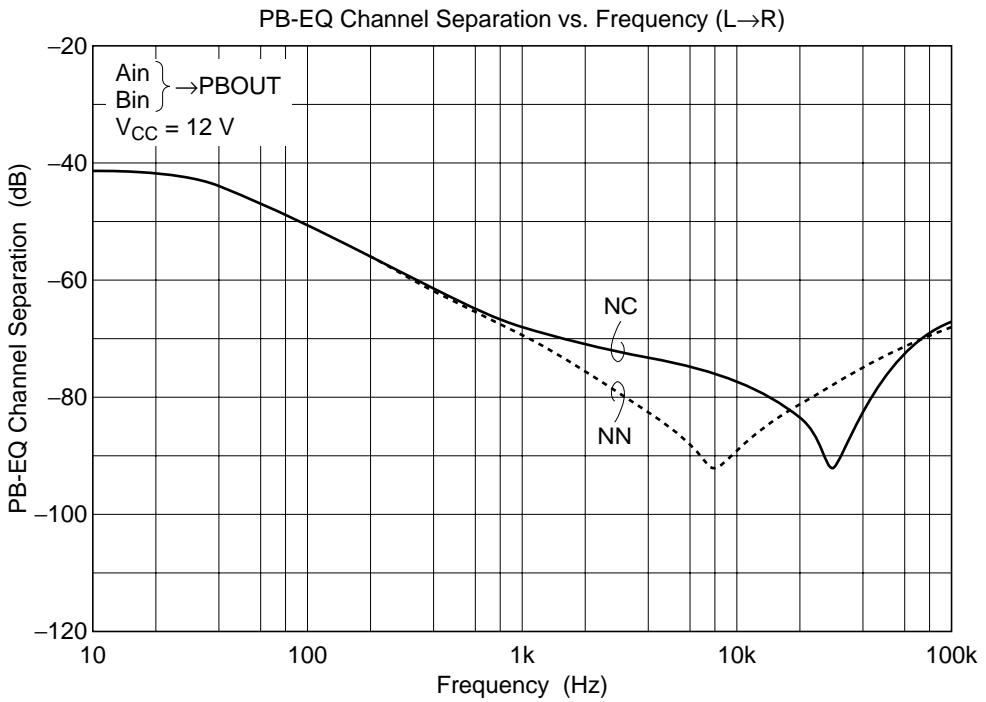
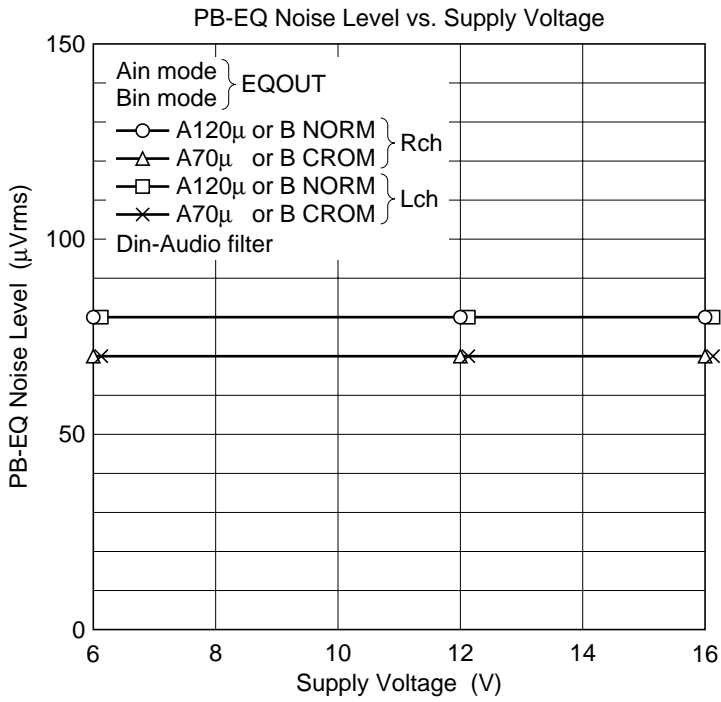

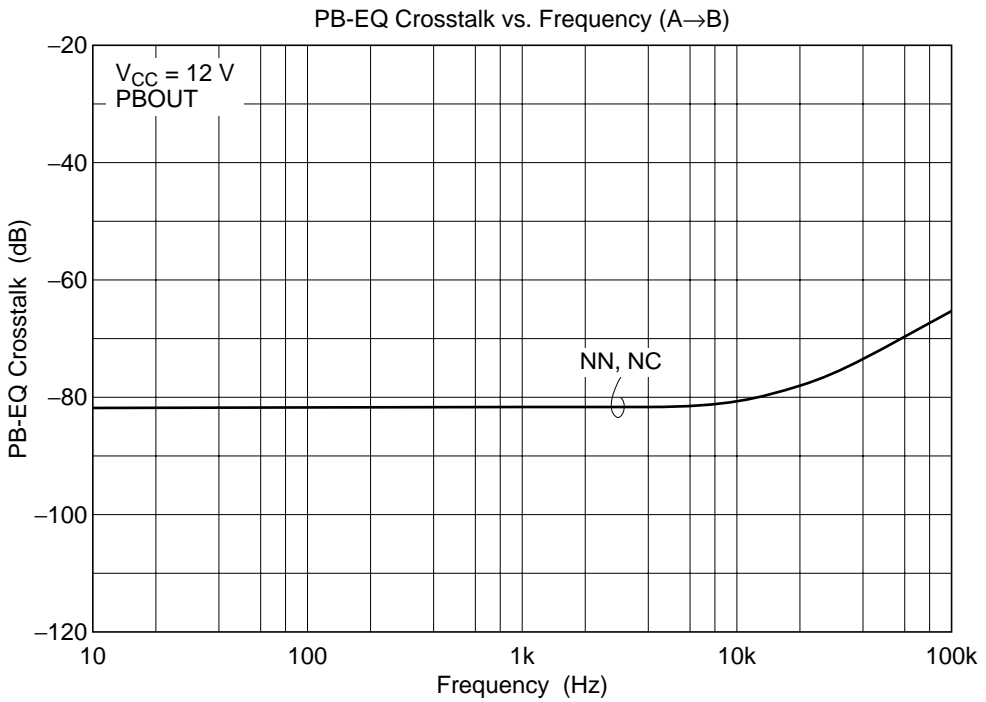
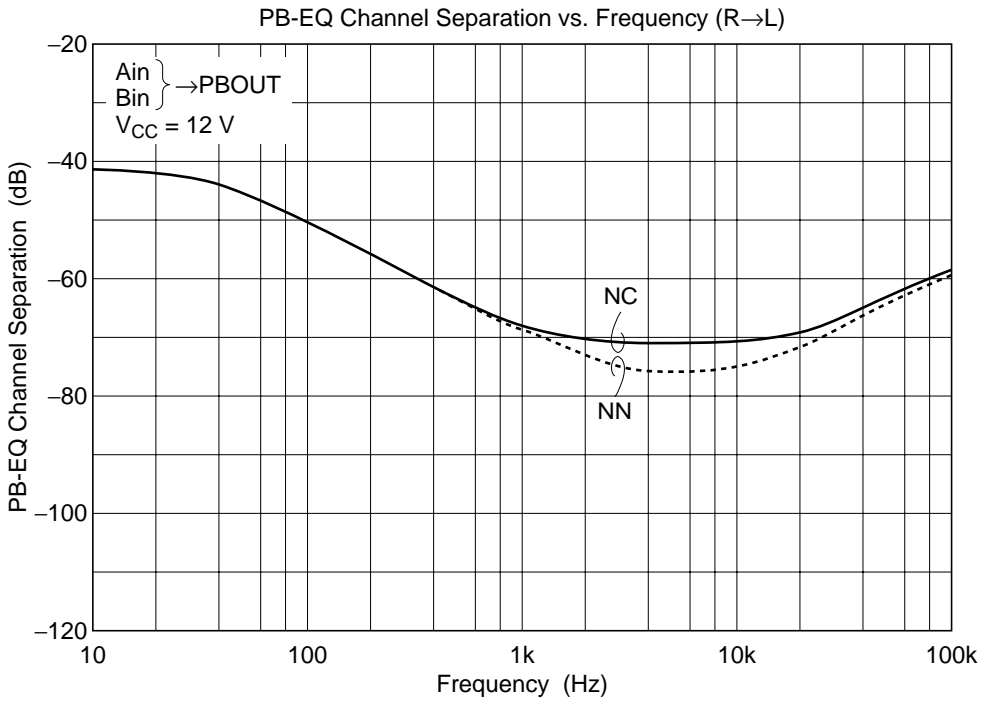

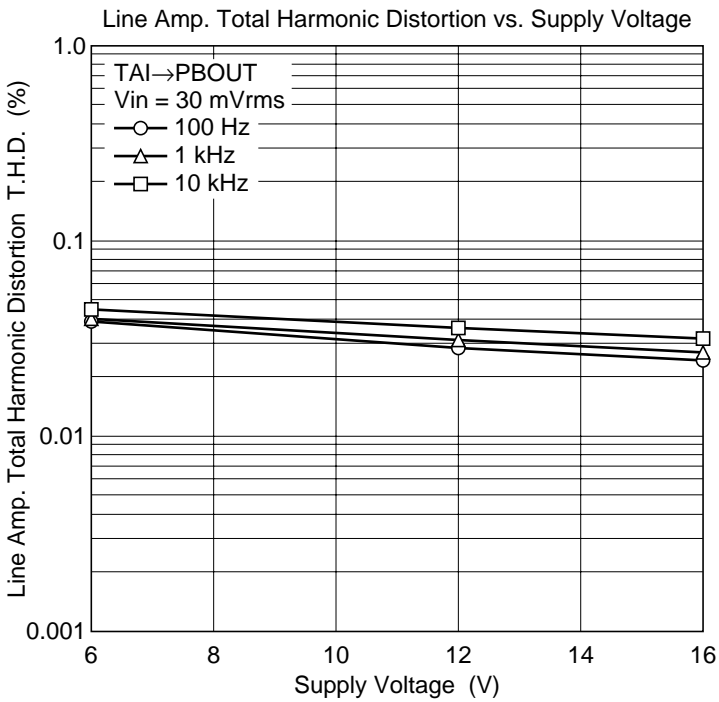
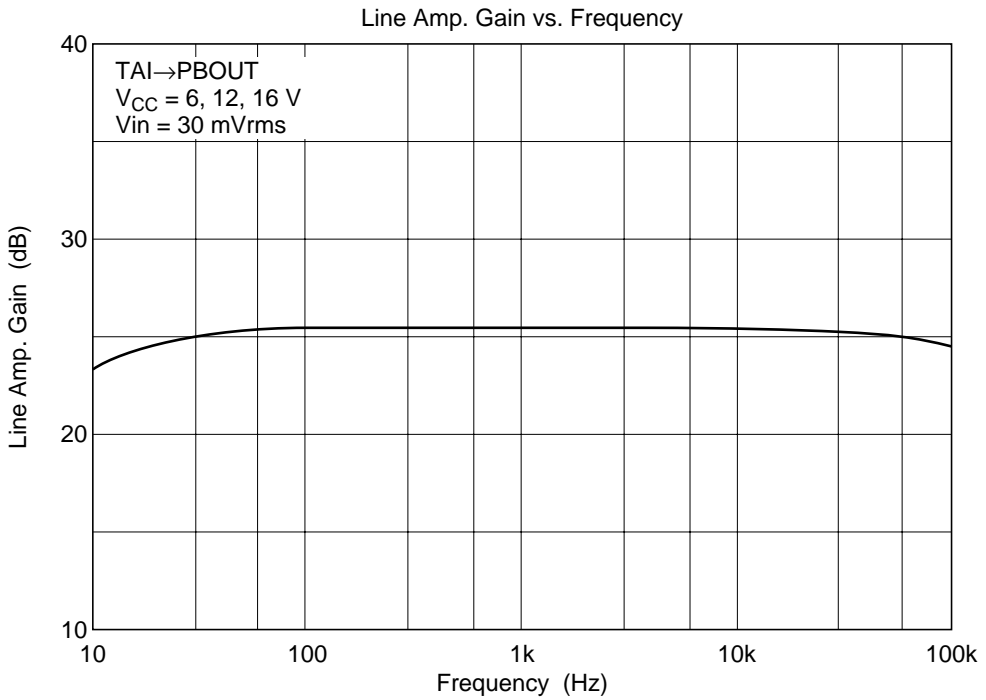

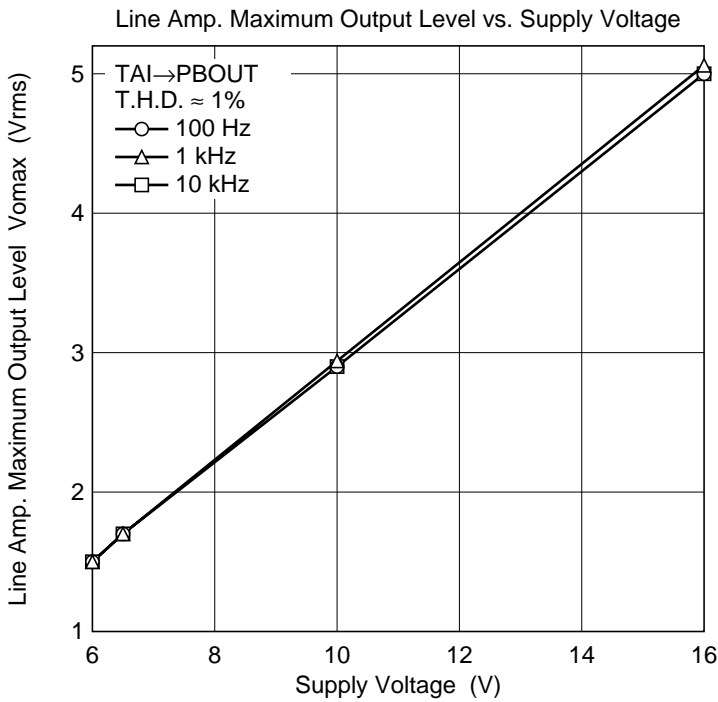
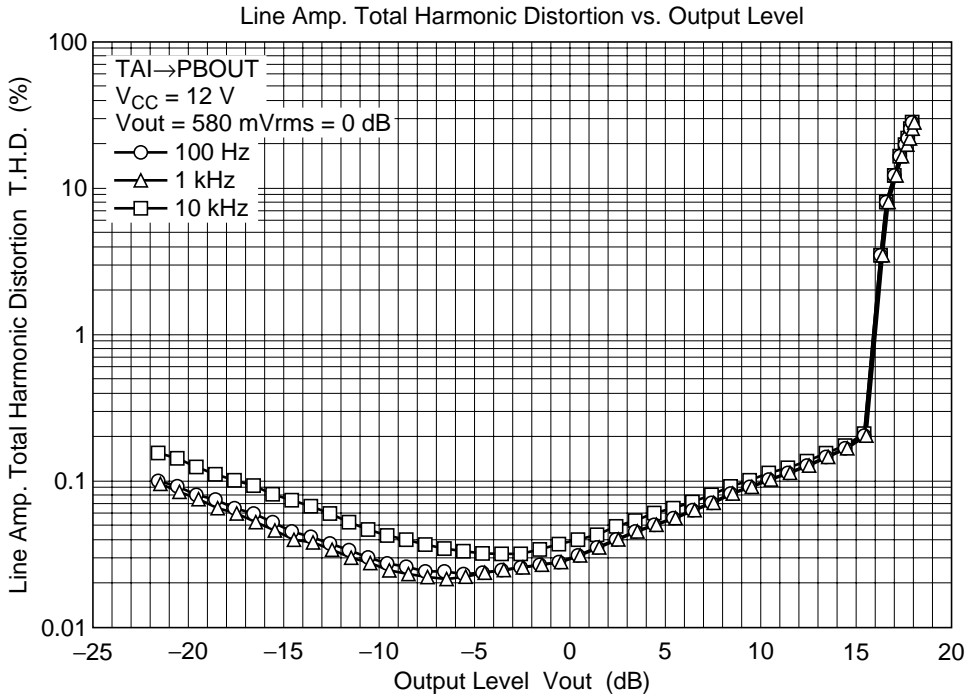

MS Amp. Gain vs. Frequency

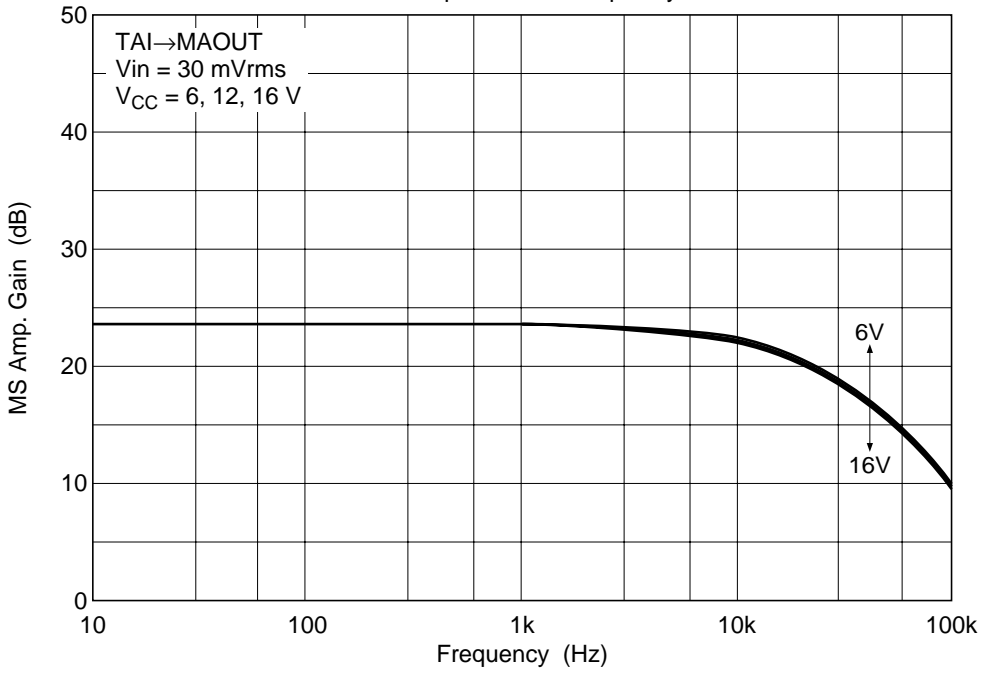

Line Mute Attenuation vs. Frequency

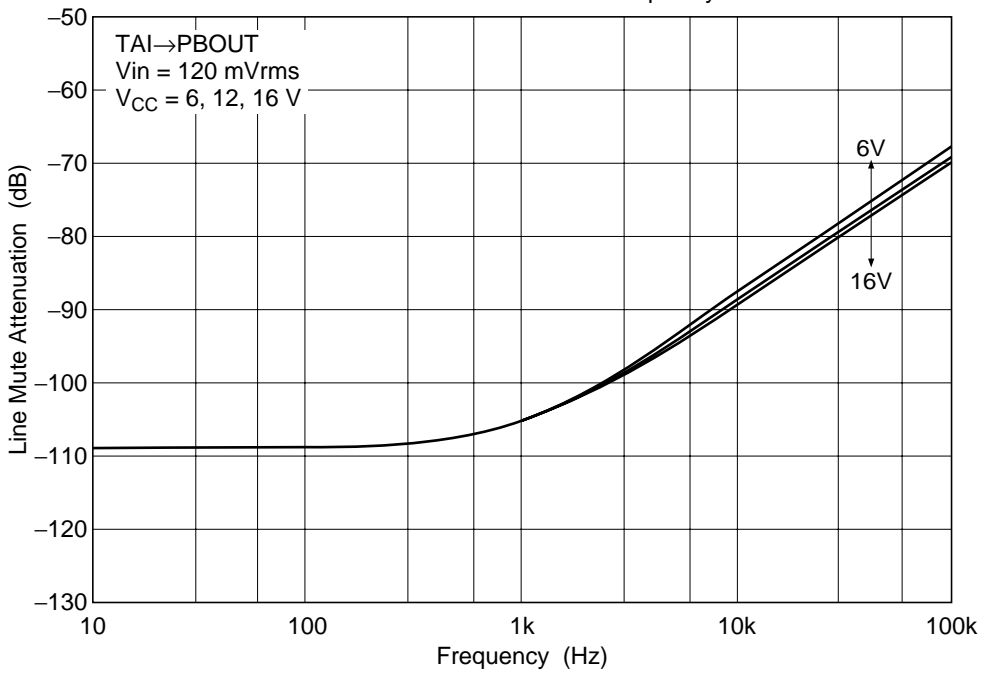

REC-EQ Gain vs. Frequency

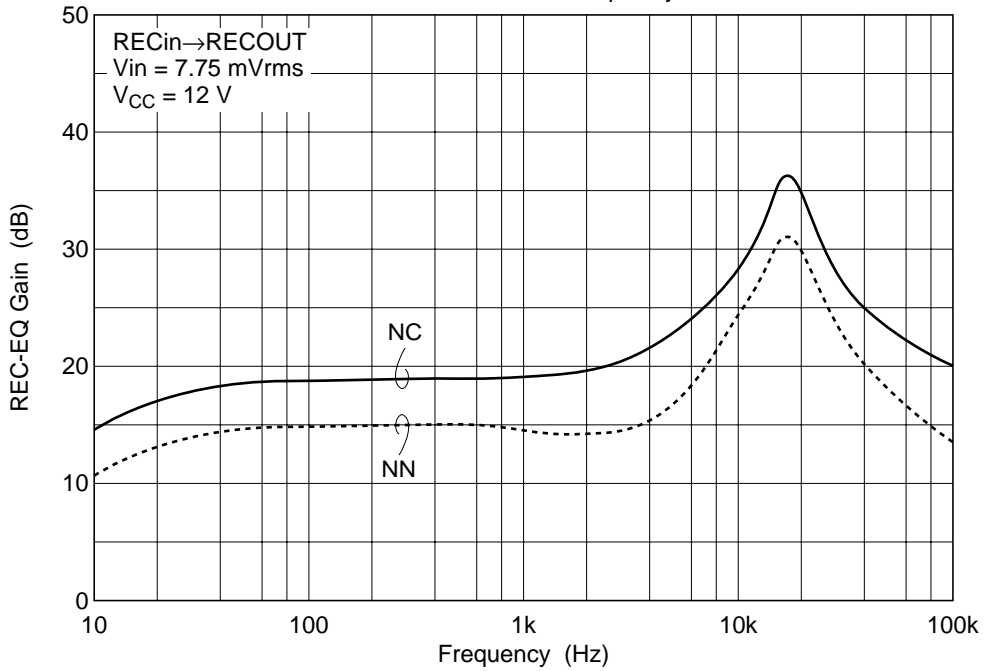

REC-EQ Channel Separation vs. Frequency (1)

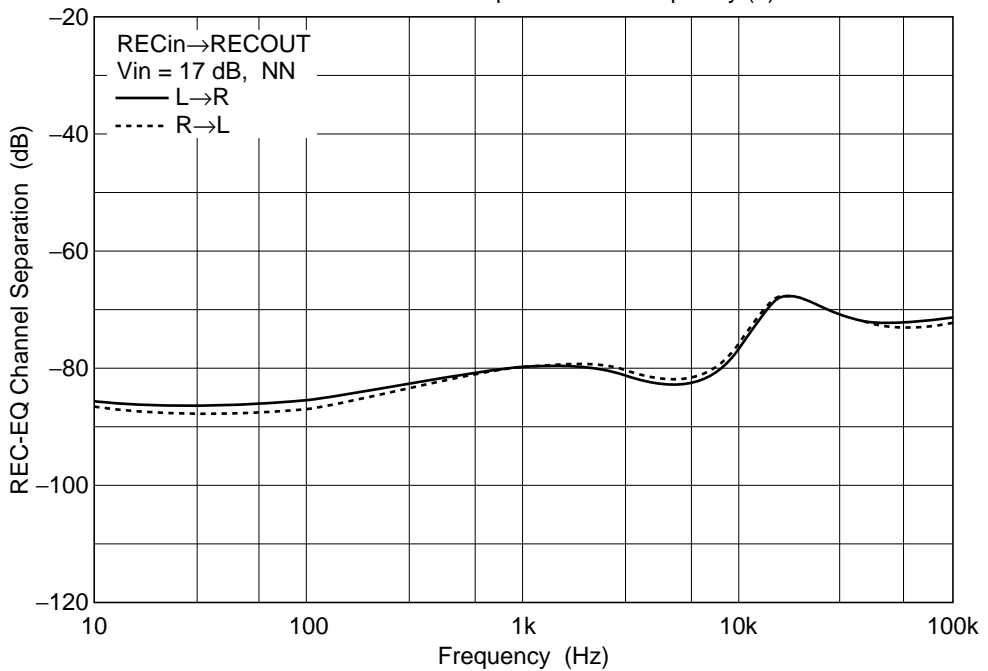

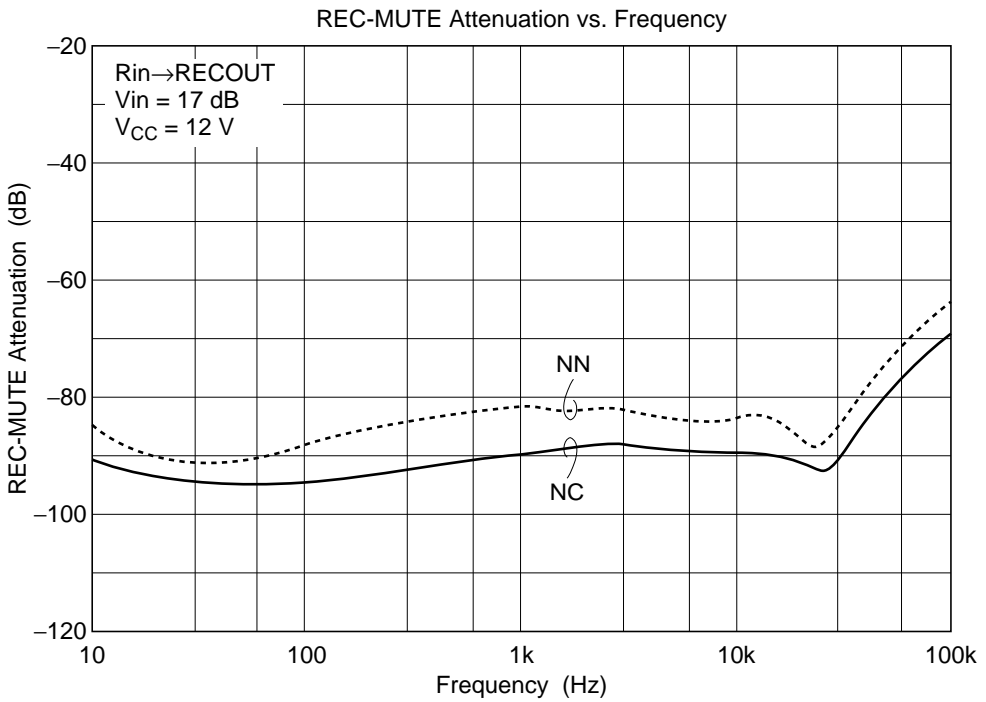
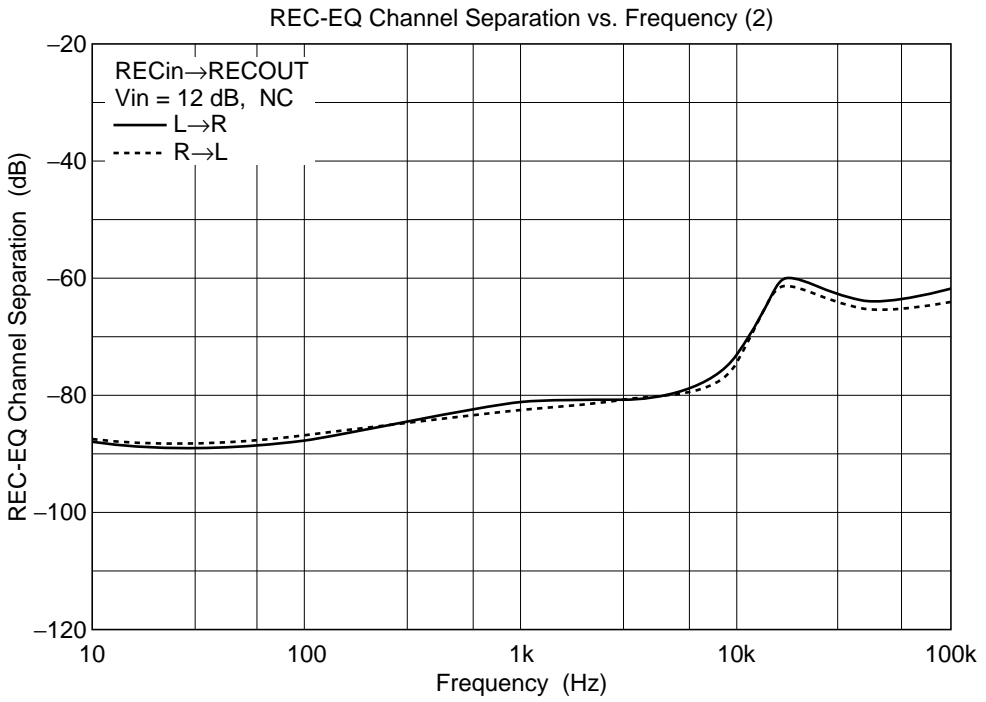

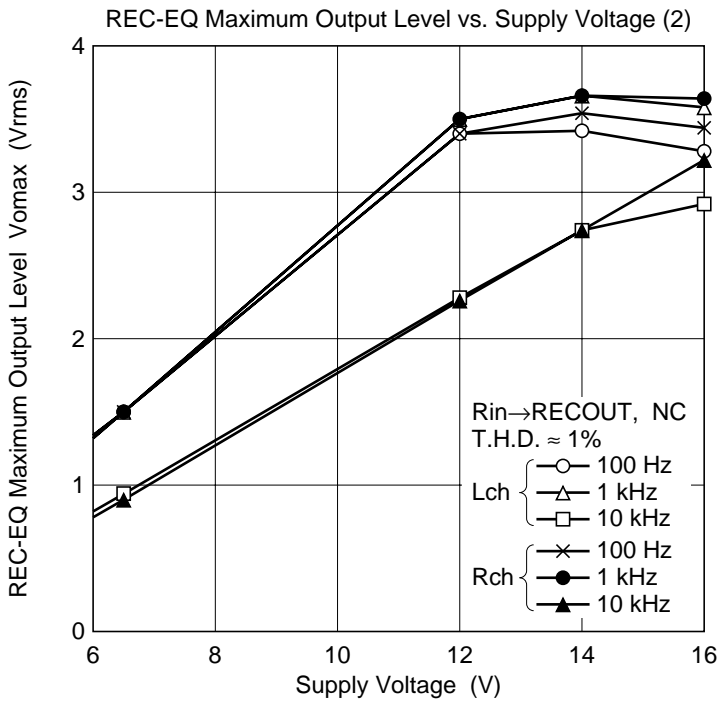
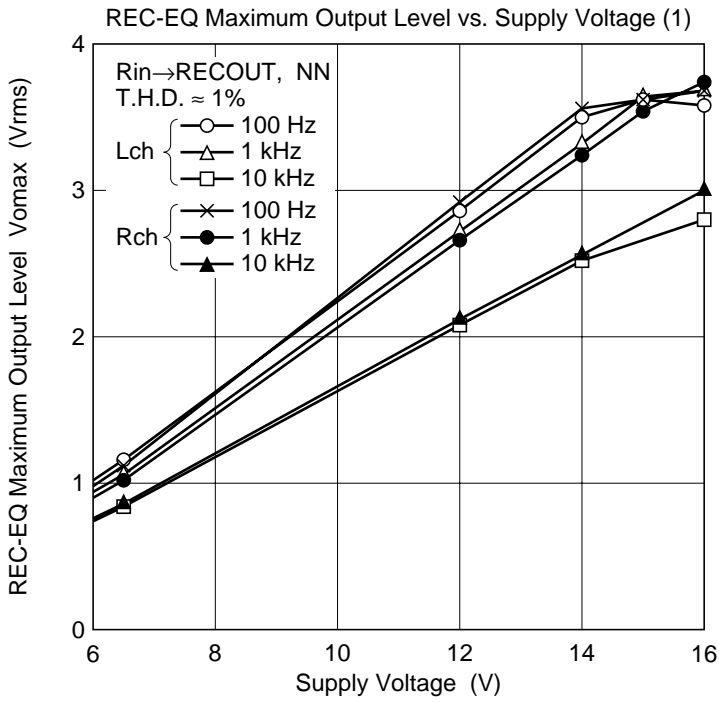

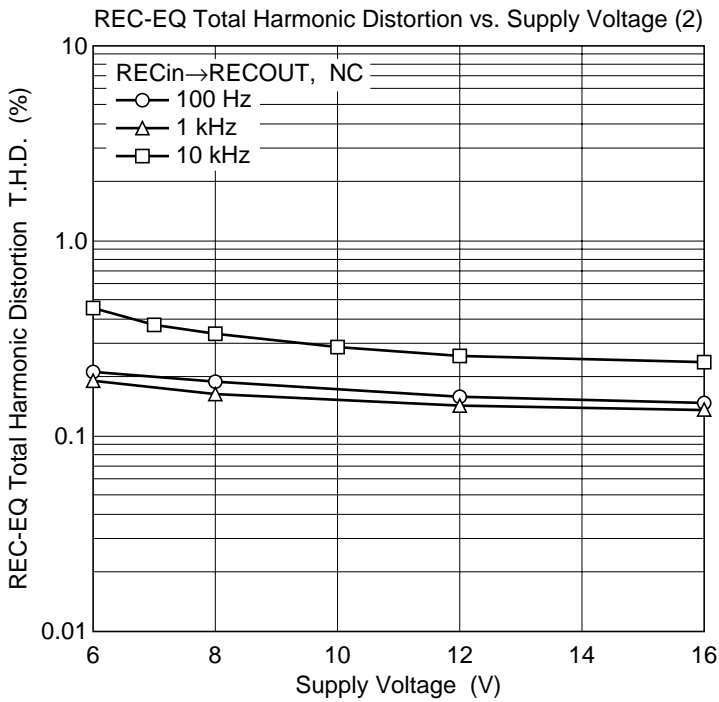
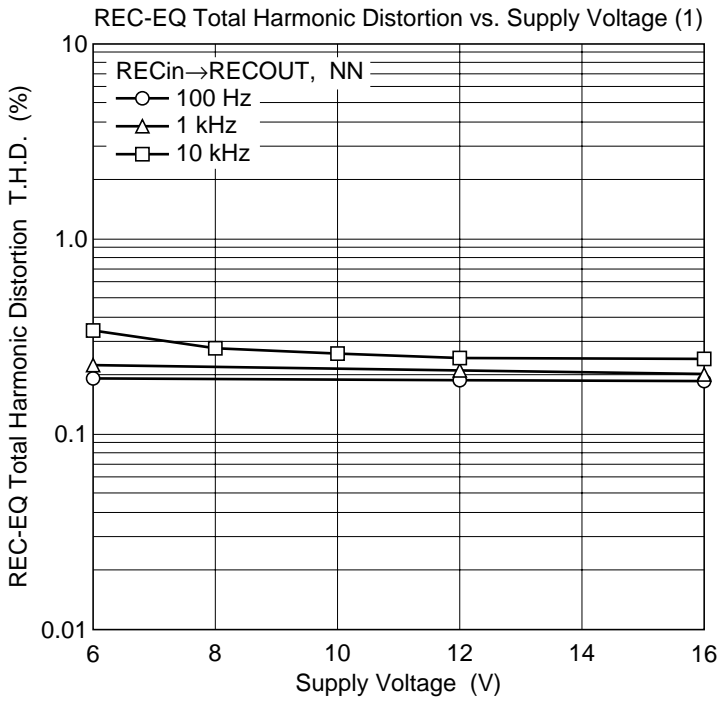

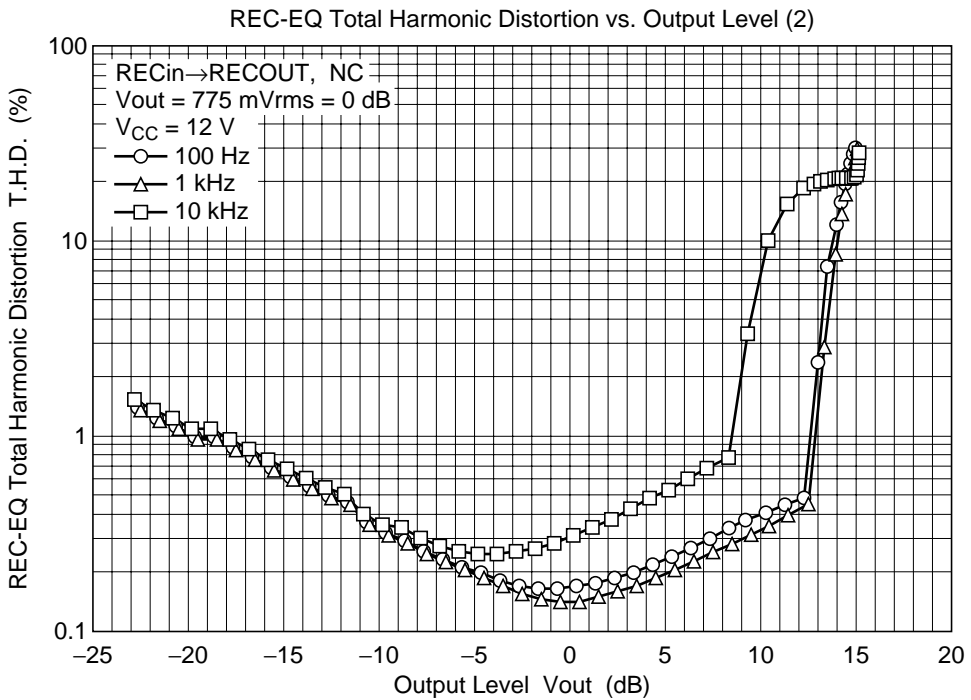
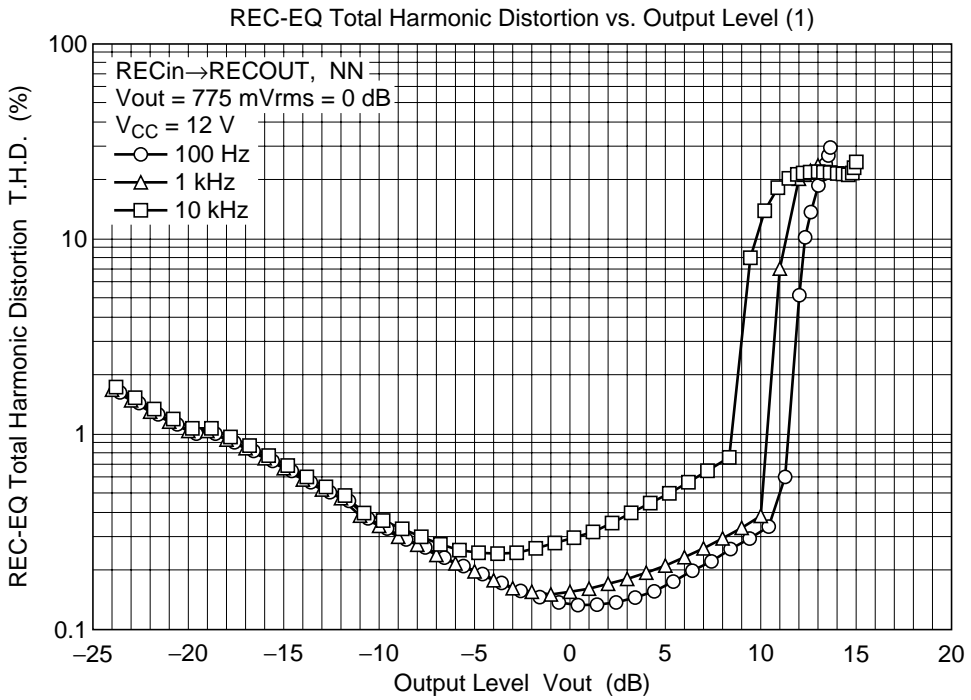

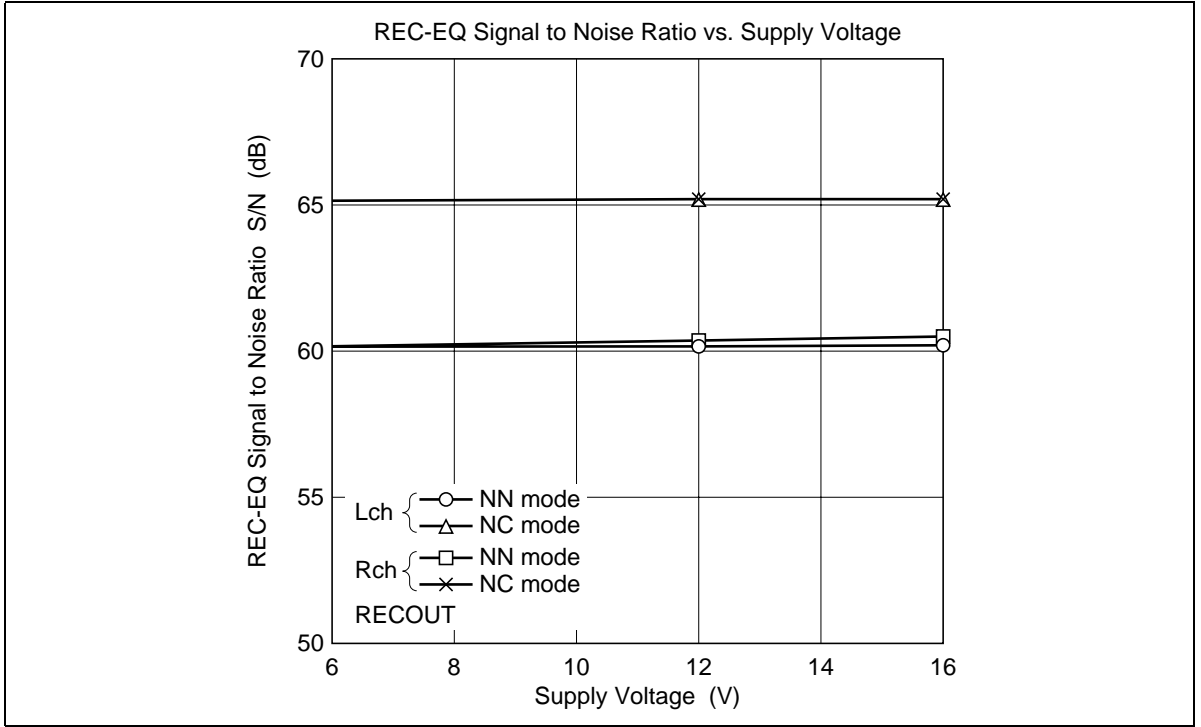

Package Dimensions

Unit: mm

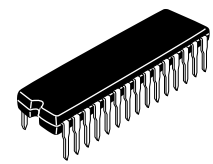
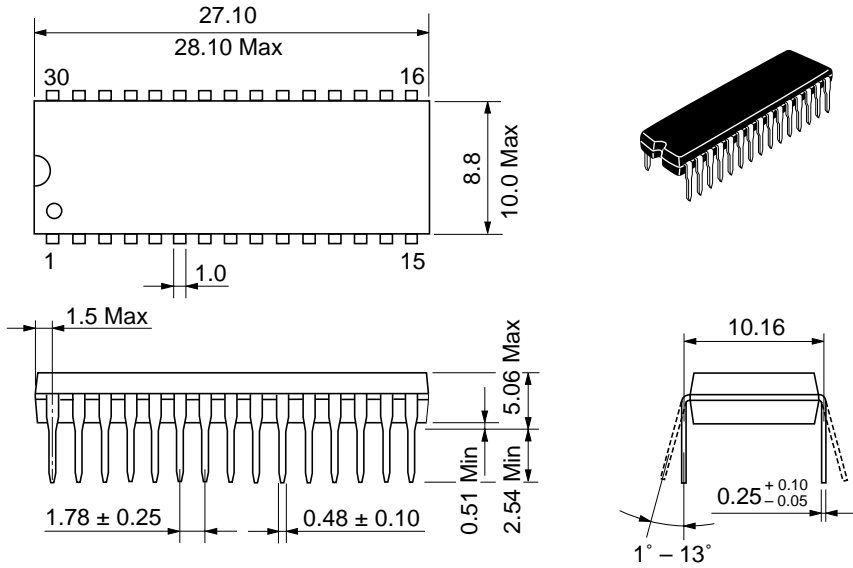

Hitachi Code	DP-30S
JEDEC	—
EIAJ	Conforms
Mass(reference value)	1.98 g

Disclaimer

1. Hitachi neither warrants nor grants licenses of any rights of Hitachi's or any third party's patent, copyright, trademark, or other intellectual property rights for information contained in this document. Hitachi bears no responsibility for problems that may arise with third party's rights, including intellectual property rights, in connection with use of the information contained in this document.
2. Products and product specifications may be subject to change without notice. Confirm that you have received the latest product standards or specifications before final design, purchase or use.
3. Hitachi makes every attempt to ensure that its products are of high quality and reliability. However, contact Hitachi's sales office before using the product in an application that demands especially high quality and reliability or where its failure or malfunction may directly threaten human life or cause risk of bodily injury, such as aerospace, aeronautics, nuclear power, combustion control, transportation, traffic, safety equipment or medical equipment for life support.
4. Design your application so that the product is used within the ranges guaranteed by Hitachi particularly for maximum rating, operating supply voltage range, heat radiation characteristics, installation conditions and other characteristics. Hitachi bears no responsibility for failure or damage when used beyond the guaranteed ranges. Even within the guaranteed ranges, consider normally foreseeable failure rates or failure modes in semiconductor devices and employ systemic measures such as fail-safes, so that the equipment incorporating Hitachi product does not cause bodily injury, fire or other consequential damage due to operation of the Hitachi product.
5. This product is not designed to be radiation resistant.
6. No one is permitted to reproduce or duplicate, in any form, the whole or part of this document without written approval from Hitachi.
7. Contact Hitachi's sales office for any questions regarding this document or Hitachi semiconductor products.

Sales Offices

HITACHI

Hitachi, Ltd.

Semiconductor & Integrated Circuits.
Nippon Bldg., 2-6-2, Ohte-machi, Chiyoda-ku, Tokyo 100-0004, Japan
Tel: Tokyo (03) 3270-2111 Fax: (03) 3270-5109

URL NorthAmerica : <http://semiconductor.hitachi.com/>
 Europe : <http://www.hitachi-eu.com/hel/ecg>
 Asia : <http://sicapac.hitachi-asia.com>
 Japan : <http://www.hitachi.co.jp/Sicd/indx.htm>

For further information write to:

Hitachi Semiconductor
(America) Inc.
179 East Tasman Drive,
San Jose, CA 95134
Tel: <1>(408) 433-1990
Fax: <1>(408) 433-0223

Hitachi Europe GmbH
Electronic Components Group
Dornacher Straße 3
D-85622 Feldkirchen, Munich
Germany
Tel: <49> (89) 9 9180-0
Fax: <49> (89) 9 29 30 00

Hitachi Europe Ltd.
Electronic Components Group.
Whitebrook Park
Lower Cookham Road
Maidenhead
Berkshire SL6 8YA, United Kingdom
Tel: <44> (1628) 585000
Fax: <44> (1628) 585160

Hitachi Asia Ltd.
Hitachi Tower
16 Collyer Quay #20-00,
Singapore 049318
Tel : <65>-538-6533/538-8577
Fax : <65>-538-6933/538-3877
URL : <http://www.hitachi.com.sg>

Hitachi Asia Ltd.
(Taipei Branch Office)
4/F, No. 167, Tun Hwa North Road,
Hung-Kuo Building,
Taipei (105), Taiwan
Tel : <886>-(2)-2718-3666
Fax : <886>-(2)-2718-8180
Telex : 23222 HAS-TP
URL : <http://www.hitachi.com.tw>

Hitachi Asia (Hong Kong) Ltd.
Group III (Electronic Components)
7/F., North Tower,
World Finance Centre,
Harbour City, Canton Road
Tsim Sha Tsui, Kowloon,
Hong Kong
Tel : <852>-(2)-735-9218
Fax : <852>-(2)-730-0281
URL : <http://www.hitachi.com.hk>

Copyright © Hitachi, Ltd., 2000. All rights reserved. Printed in Japan.
Colophon 2.0