

# HA16662MP, HA16682MP

## HDD Interface Circuit

### Description

The HA16662MP/682MP monolithic IC is designed for ST-506 interface logics in hard disk drive memory systems.

### Functions

- RS-422 receiver, driver pair
- ST-506 interface line driver
- Line receiver with hysteresis input threshold
- ST-506 interface logic
- Two-channel supply voltage monitor circuit for 5 V and 12 V
- Reset signal generator for microprocessor
- Write gate signal and write fault signal generator for R/W amp. IC.

### Features

- Can directly connect with MPU: 6301V, 6301X, 6305V, 8049, etc.
- Reduces number of logic components for I/O interface
- No external TTLs and RS-422 receiver driver
- Write inhibit input for embedded servo system
- Highly reliable fail-safe with write inhibit functions for power-on period and abnormal supply voltage
- Small surface mount package (MSP: mini-square-package) for high density PCB

### Ordering Information

Type No.	Package
HA16662MP, HA16682MP	MP-44

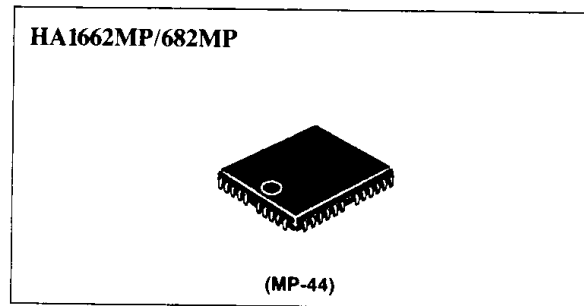

### Pin Arrangement

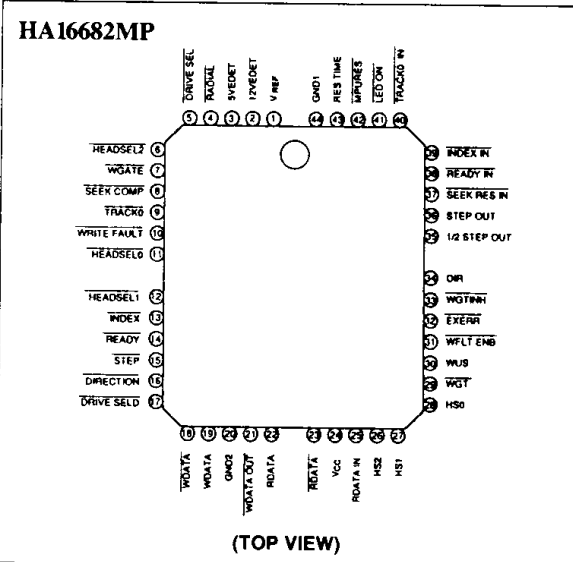
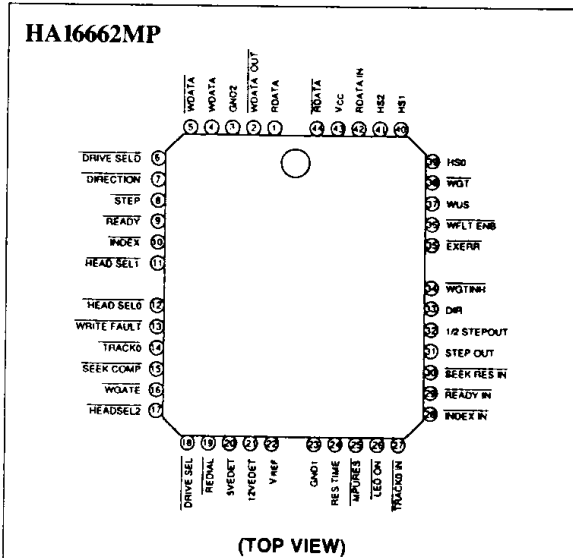

Block Diagram

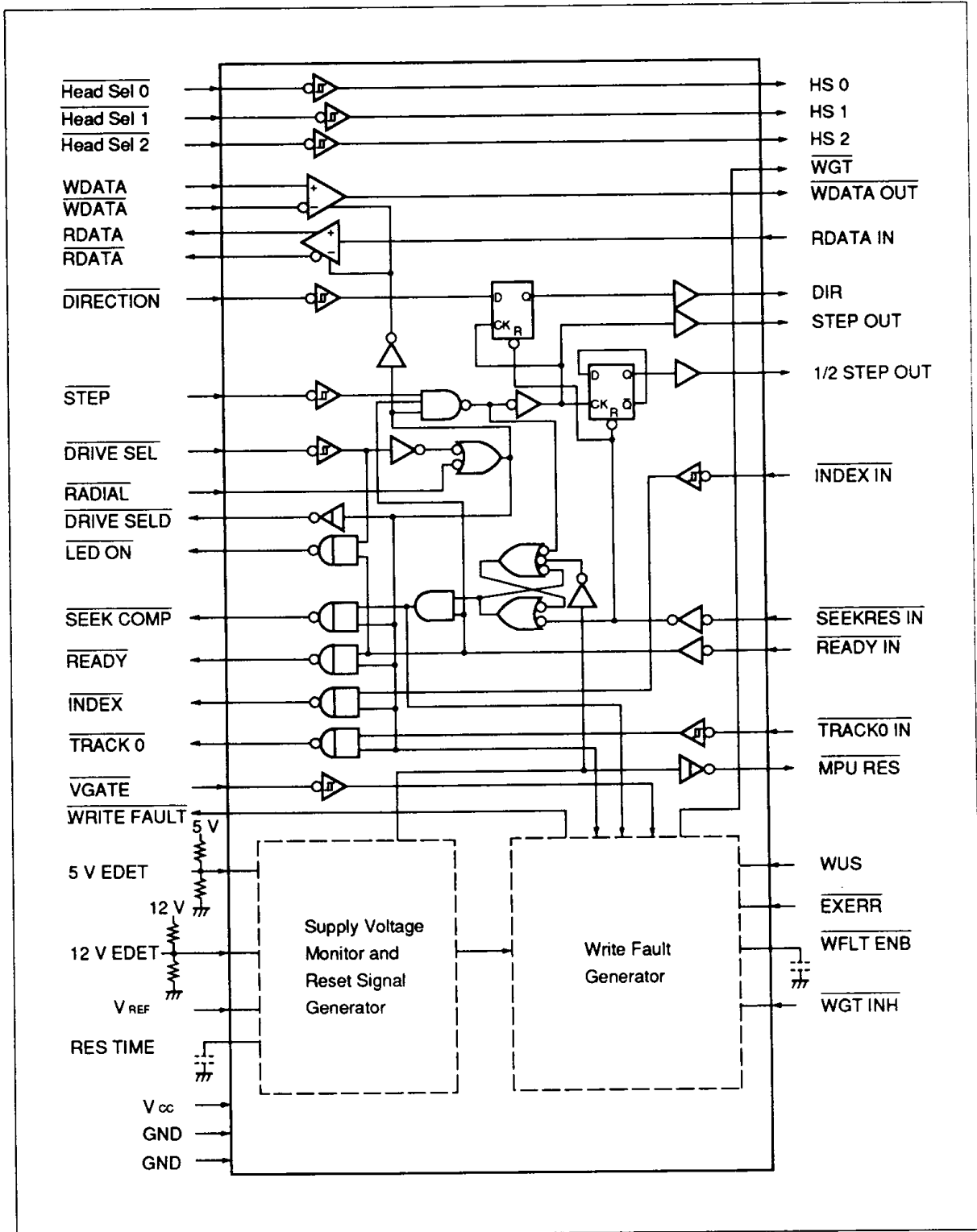

# HA16662MP, HA16682MP

## Absolute Maximum Ratings (Ta = 25°C)

Item	Symbol	Ratings	Unit	Notes
Supply voltage	VCC	7	V	
Input voltage 1	VIN1	7	V	1
Input voltage 2	VIN2	VCC	V	2
Differential input voltage	VDIN	±7	V	3
Output voltage 1	VOUT1	7	V	4
Output voltage 2	VOUT2	VCC	V	5
Differential output voltage	VDOUT	5.5	V	6
Output current 1	IOUT1	50	mA	7
Output current 2	IOUT2	10	mA	8
Output current 3	IOUT3	10	mA	9
Output current 4	IOUT4	-0.4	mA	10
Differential output current	IDOUT	30	mA	11
Operating temperature range	Topr	0 to +70	°C	
Storage temperature range	Tstg	-55 to +125	°C	
Power dissipation	PT	750	mW	

The absolute maximum ratings are limiting values, to be applied individually, beyond which the device may be permanently damaged. Functional operation under any of these conditions is not guaranteed. Exposing a circuit to its absolute maximum rating for extended periods of time may affect the device's reliability.

- Notes:
1. Applies to schmit-trigger inputs and other inputs equivalent to 74LS04:  
HEAD SEL 0 – HEAD SEL 2 DIRECTION, STEP, DRIVE SEL, TRACK 0 IN, INDEX IN, RDATAIN, SEEK RES IN, READYIN, WUS, EXERR, WGTINH, WGATE
  2. Applies to the following inputs:  
5 V EDET, 12 V EDET, VREF, RESTIME, WFLTENB, RADIAL
  3. Applies to the following differential receiver inputs:  
WDATA, WDATA
  4. Applies to the following open collector outputs in the off mode:  
DRIVESEL, LED ON, SEEK COMP, READY, INDEX, TRACK 0, WRITE FAULT, MPURES
  5. Applies to the following outputs when high:  
HS 0 - HS 2, WGT, WDATAOUT, DIR, STEP OUT, 1/2 STEP OUT
  6. Applies to the following differential driver outputs when high:  
RDATA, RDATA
  7. Applies to the following open collector outputs in the on mode:  
DRIVE SEL, LED ON, SEEK COMP, READY, INDEX, TRACK 0, WRITE FAULT
  8. Applies to the following open collector output in the on mode:  
MPURES
  9. Applies to the following outputs when low:  
HS 0 - HS 2, WGT, WDATA OUT, DIR, STEP OUT, 1/2 STEP OUT
  10. Applies to the same outputs as note 9 when high:
  11. Applies to the following differential driver outputs:  
RDATA, RDATA



Electrical Characteristics (Ta = 25°C)

Item	Pin	Symbol	Min	Typ	Max	Unit	Test Condition
Supply voltage range		VCC	4.5	5.0	5.5	V	
High level input threshold voltage	HEADSEL 0, HEADSEL 1,	VT1+	—	1.7	—	V	VCC = 5 V
Low level input threshold voltage	HEADSEL 2, DIRECTION, STEP,	VT1-	—	0.9	—	V	VCC = 5 V
Hysteresis	DRIVESEL,	VHYS1	—	0.8	—	V	VCC = 5 V
High level input current	WGATE, TRACK0 IN, INDEX IN,	I IH1	—	—	20	μA	VCC = 5.5 V, VIN = 2.7 V
Low level input current	WGATE,	I IL1	-0.4	—	—	mA	VCC = 5.5 V, VIN = 0.4 V
Differential input voltage	WDATA, WDATA	VDIN	1.0	—	—	V	-5.5 V < VCM < 5.5 V
High level differential input current		I IN1+	—	—	1	mA	VIN = +5.5 V, other VIN = 0
Low level differential input current		I IN1-	-1.5	—	—	mA	VIN = -5.5 V, other VIN = 0
Input hysteresis		VDHYS	—	50	—	mV	VCC = 5 V, VCM = 0 V
High level output voltage 1	WDATAOUT	VOH1	2.7	—	—	V	VCC = 4.75 V, WDATA = 0 V, WDATA = 1 V, IOH = -0.44 mA
High level output voltage 2		VOH2	2.5	—	—	V	VCC = 4.5 V, WDATA = 0 V WDATA = 1 V, IOH = -0.44 mA
Low level output voltage 1		VOL1	—	—	0.4	V	VCC = 4.5 V, VDIN = 1.0 V IOL = 4.0 mA
Low level output voltage 2		VOL2	—	—	0.45	V	VCC = 4.5 V, VDIN = 1.0 V IOL = 8.0 mA
High impedance output current 1		I ZOUT1	—	—	50	μA	VCC = 5.5 V, VO = 2.4 V
High impedance output current 2		I ZOUT2	-50	—	—	μA	VCC = 5.5 V, VO = 0.4 V

# HA16662MP, HA16682MP

## Electrical Characteristics (Continued)

Item	Pin	Symbol	Min	Typ	Max	Unit	Test Condition
High level input voltage 1	RDATAIN	V <sub>IH1</sub>	2.0	—	—	V	V <sub>CC</sub> = 4.5 V
Low level input voltage 1		V <sub>IL1</sub>	—	—	0.8	V	V <sub>CC</sub> = 5.5 V
High level input current 2		I <sub>IH2</sub>	—	—	20	μA	V <sub>CC</sub> = 5.5 V, V <sub>IN</sub> = 2.7 V
Low level input current 2		I <sub>IL2</sub>	-0.36	—	—	mA	V <sub>CC</sub> = 5.5 V, V <sub>IN</sub> = 0.4 V
High level output voltage 3	RDATA, RDATA	V <sub>OH3</sub>	2.5	—	—	V	V <sub>CC</sub> = 4.75 V, I <sub>OH</sub> = -20 mA
High level output voltage 4		V <sub>OH4</sub>	2.2	—	—	V	V <sub>CC</sub> = 4.5 V, I <sub>OH</sub> = -20 mA
Low level output voltage 3		V <sub>OL3</sub>	—	—	0.5	V	V <sub>CC</sub> = 4.5 V, I <sub>OL</sub> = 20 mA
High impedance output current 3		I <sub>ZOUT3</sub>	—	—	50	μA	V <sub>CC</sub> = 5.5 V, V <sub>OUT</sub> = 2.5 V
High impedance output current 4		I <sub>ZOUT4</sub>	-50	—	—	μA	V <sub>CC</sub> = 5.5 V, V <sub>OUT</sub> = 0.5 V
Low level output voltage 4	DRIVE SELD, SEEK COMP, READY, INDEX,	V <sub>OL4</sub>	—	—	0.4	V	V <sub>CC</sub> = 4.5 V, I <sub>OL</sub> = 48 mA
High level output current 1	TRACK0, WRITE FAULT, LED ON	I <sub>OH1</sub>	—	—	250	μA	V <sub>CC</sub> = 4.5 V, V <sub>OH</sub> = 5.5 V
High level input voltage 2	SEEK RESIN, READY IN,	V <sub>IH2</sub>	2.0	—	—	V	V <sub>CC</sub> = 4.5 V
Low level input voltage 2	WGTINH, WUS	V <sub>IL2</sub>	—	—	0.8	V	V <sub>CC</sub> = 5.5 V
High level input current 3		I <sub>IH3</sub>	—	—	20	μA	V <sub>CC</sub> = 5.5 V, V <sub>I</sub> = 2.7 V
Low level input current 3		I <sub>IL3</sub>	-0.4	—	—	mA	V <sub>CC</sub> = 5.5 V, V <sub>I</sub> = 0.4 V



## Electrical Characteristics (Continued)

Item	Pin	Symbol	Min	Typ	Max	Unit	Test Condition
High level input voltage 3	<u>RADIAL</u>	V <sub>IH3</sub>	2.0	—	—	V	
Low level input voltage 3		V <sub>IL3</sub>	—	—	0.8	V	
High level input current 4		I <sub>IH4</sub>	-0.5	—	—	mA	V <sub>CC</sub> = 5.5 V, V <sub>I</sub> = 2.7 V
Low level input current 4		I <sub>IL4</sub>	-1.2	—	—	mA	V <sub>CC</sub> = 5.5 V, V <sub>I</sub> = 0.4 V
High level output voltage 5	HS 0, HS 1, HS 2,	V <sub>OH5</sub>	2.7	—	—	V	V <sub>CC</sub> = 4.75 V, V <sub>I</sub> = 0.8 V I <sub>OH</sub> = -0.4 mA
High level output voltage 6	WGT, DIR, STEP OUT, 1/2 STEP OUT,	V <sub>OH6</sub>	2.5	—	—	V	V <sub>CC</sub> = 4.5 V, V <sub>I</sub> = 0.8 V I <sub>OH</sub> = -0.4 mA
Low level output voltage 5		V <sub>OL5</sub>	—	—	0.4	V	V <sub>CC</sub> = 4.5 V, V <sub>I</sub> = 2 V, I <sub>OL</sub> = 4 mA
Low level output voltage 6		V <sub>OL6</sub>	—	—	0.5	V	V <sub>CC</sub> = 4.5 V, V <sub>I</sub> = 2 V, I <sub>OL</sub> = 8 mA
Low level output voltage 7	<u>MPURES</u>	V <sub>OL7</sub>	—	—	0.4	V	V <sub>CC</sub> = 4.5 V, V <sub>I</sub> = 2 V, I <sub>OL</sub> = 8 mA
High level output current 7		I <sub>OH7</sub>	—	—	250	μA	V <sub>CC</sub> = 4.5 V, V <sub>I</sub> = 0.8 V, V <sub>OH</sub> = 5.5 V
High level input threshold voltage	<u>EXERR,</u> <u>WFLTENB</u>	V <sub>T2+</sub>	—	1.7	—	V	V <sub>CC</sub> = 5 V
Low level input threshold voltage		V <sub>T2-</sub>	—	0.9	—	V	V <sub>CC</sub> = 5 V
Hysteresis		V <sub>HYS2</sub>	—	0.8	—	V	V <sub>CC</sub> = 5 V
High level input current		I <sub>IH5</sub>	—	—	20	μA	V <sub>CC</sub> = 5.5 V, V <sub>IN</sub> = 2.7 V
Low level input current		I <sub>IL5</sub>	-0.4	—	—	mA	V <sub>CC</sub> = 5.5 V, V <sub>IN</sub> = 0.4 V
Internal charge up resistance	<u>WFLTENB</u>	R <sub>C</sub>	140	200	260	Ω	

# HA16662MP, HA16682MP

## Electrical Characteristics (Continued)

Item	Pin	Symbol	Min	Typ	Max	Unit	Test Condition
Sense voltage range 1	5VEDET	VSVR1	0	—	V <sub>CC</sub> -1.0	V	V <sub>CC</sub> ≥ 2 V
Input bias current 1		IIB1	—	40	60	μA	V <sub>CC</sub> = 5.5 V, 5VEDET = 2.4 V, V <sub>REF</sub> = 2.5 V, 12VEDET = 2.9 V
Input bias current 2		IIB2	—	—	2	μA	V <sub>CC</sub> = 5.5 V, 5VEDET = 5.5 V, V <sub>REF</sub> = 2.5 V, 12VEDET = 2.9 V
Hysteresis		VHYS3	—	(140)	—	mV	V <sub>REF</sub> = 2.5 V, R <sub>1</sub> = 1.3 kΩ, R <sub>2</sub> = 1.8 kΩ (Figure 1)
Sense voltage level 1		VSVL1	2.48	2.50	2.52	V	V <sub>REF</sub> = 2.5 V, V <sub>CC</sub> = 5 V
Sense voltage range 2	12VEDET	VSVR2	0	—	V <sub>CC</sub> -1.0	V	V <sub>CC</sub> ≥ 2 V
Input bias current 3		IIB3	—	35	50	μA	V <sub>CC</sub> = 5.5 V, 12VEDET = 2.4 V, V <sub>REF</sub> = 2.5 V, 5VEDET = 2.9 V
Input bias current 4		IIB4	—	—	2	μA	V <sub>CC</sub> = 5.5 V, 12VEDET = 5.5 V, V <sub>REF</sub> = 2.5 V, 5VEDET = 2.9 V
Hysteresis		VHYS4	—	(270)	—	mV	V <sub>REF</sub> = 2.5 V, R <sub>1</sub> ' = 5.6 kΩ R <sub>2</sub> ' = 1.8 kΩ (Figure 1)
Sense voltage level 2		VSVL2	2.48	2.50	2.52	V	V <sub>REF</sub> = 2.5 V, V <sub>CC</sub> = 5 V
Applied reference voltage range	V <sub>REF</sub>	V <sub>REF</sub>	2	—	V <sub>CC</sub> -1.0	V	(Note)
Input bias current 5		IIB5	-3.0	-1.0	—	μA	V <sub>CC</sub> = 5.5 V, 5VEDET = 12VEDET = 2.9 V, V <sub>REF</sub> = 2.5 V
Input bias current 6		IIB6	—	—	2	μA	V <sub>CC</sub> = 5.5 V, 5VEDET = 12VEDET = 0 V, V <sub>REF</sub> = 5.5 V



**Electrical Characteristics (Continued)**

Item	Pin	Symbol	Min	Typ	Max	Unit	Test Condition
High level input threshold voltage	RESTIME	VT3+	—	2/3 V <sub>CC</sub>	—	V	V <sub>CC</sub> = 5 V
Low level input threshold voltage		VT3-	—	6/10 V <sub>CC</sub>	—	V	V <sub>CC</sub> = 5 V
Capacitor charge up current		ICHG	0.5	1	2	μA	V <sub>CC</sub> = 5 V
Dissipation current	V <sub>CC</sub>	I <sub>CC</sub>	—	—	135	mA	V <sub>CC</sub> = 5.5 V

Note: When applied reference voltage becomes less than 0.6 V, supply voltage monitor circuit generates the supply fault signal.

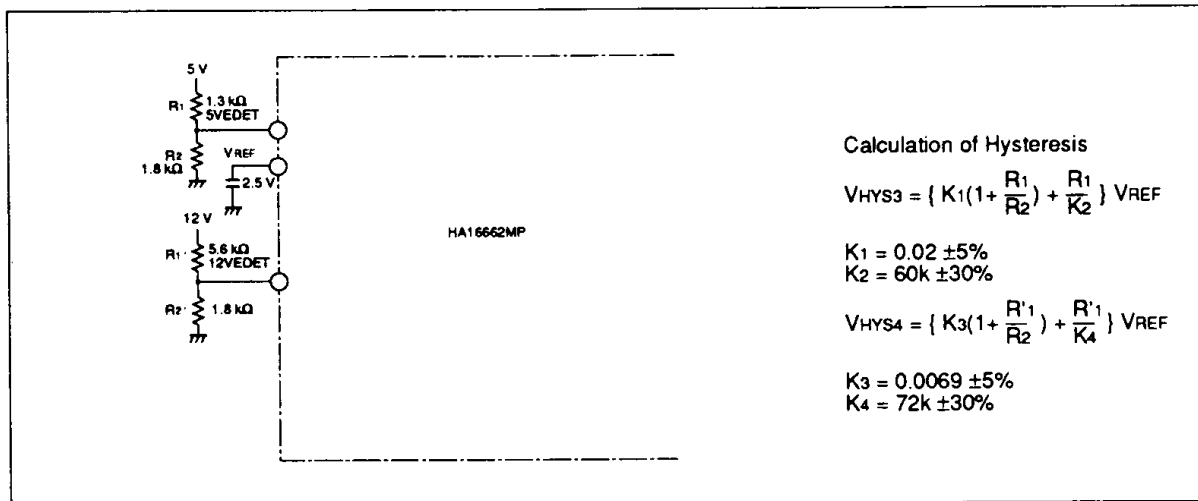

**Figure 1 Test Circuit**

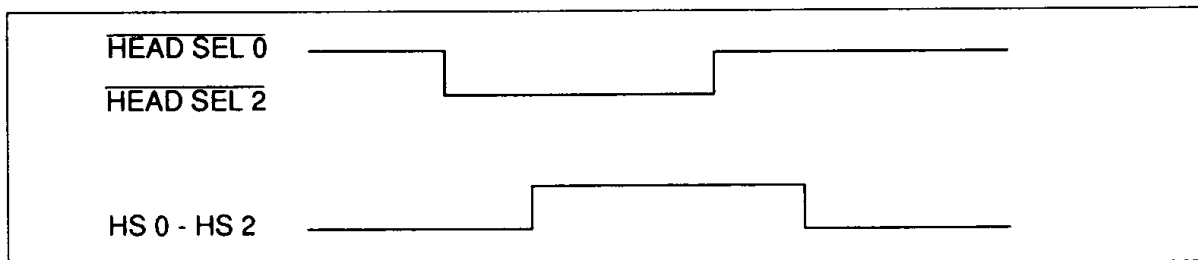

**Figure 2 HEAD SEL 0 – HEAD SEL 2 → HS 0 – HS 2 Timing**



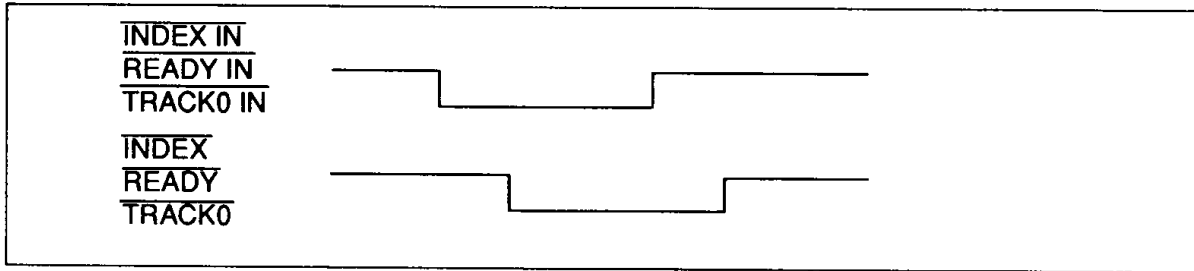

Figure 3  $\overline{\text{INDEX IN}} \rightarrow \overline{\text{INDEX}}$ ,  $\overline{\text{READY IN}} \rightarrow \overline{\text{READY}}$ ,  $\overline{\text{TRACK0 IN}} \rightarrow \overline{\text{TRACK0}}$  Timing

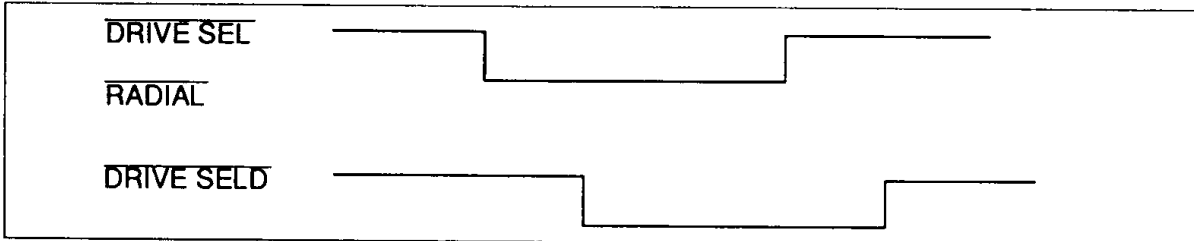

Figure 4  $\overline{\text{DRIVE SEL}}$ ,  $\overline{\text{RADIAL}} \rightarrow \overline{\text{DRIVE SELD}}$  Timing

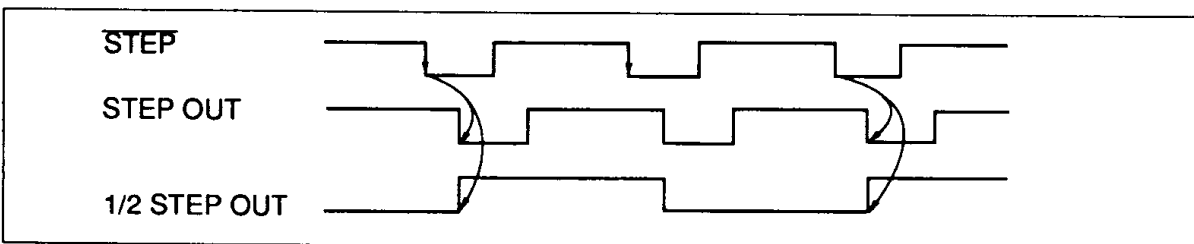

Figure 5  $\overline{\text{STEP}} \rightarrow \overline{\text{STEP OUT}}$ ,  $\overline{\text{1/2 STEP OUT}}$

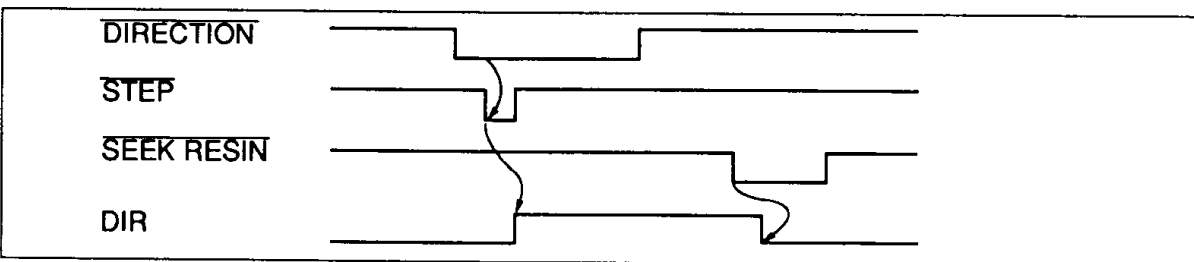

Figure 6  $\overline{\text{DIRECTION}} \rightarrow \overline{\text{DIR}}$

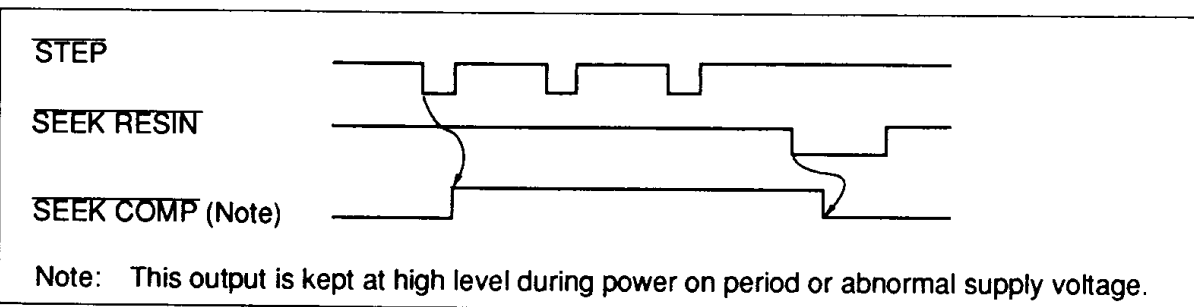

Figure 7  $\overline{\text{SEEK COMP}}$

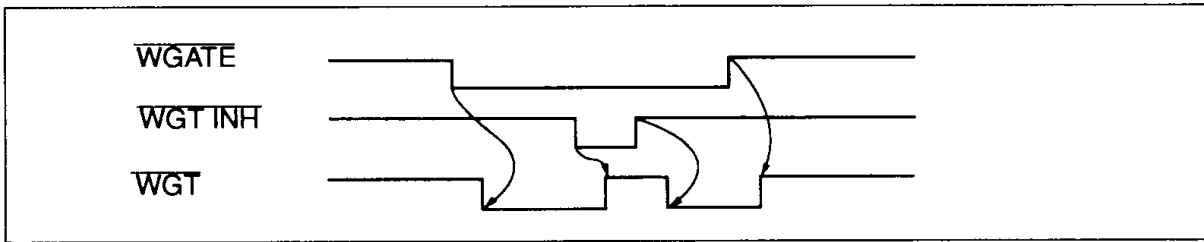

Figure 8  $\overline{\text{WGATE}}, \overline{\text{WGT INH}} \rightarrow \overline{\text{WGT}}$

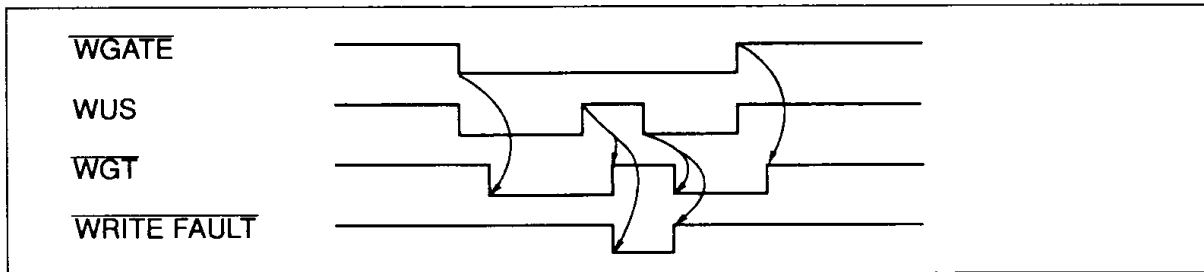

Figure 9  $\overline{\text{WGATE}}, \overline{\text{WUS}} \rightarrow \overline{\text{WRITE FAULT}}, \overline{\text{WGT}}$

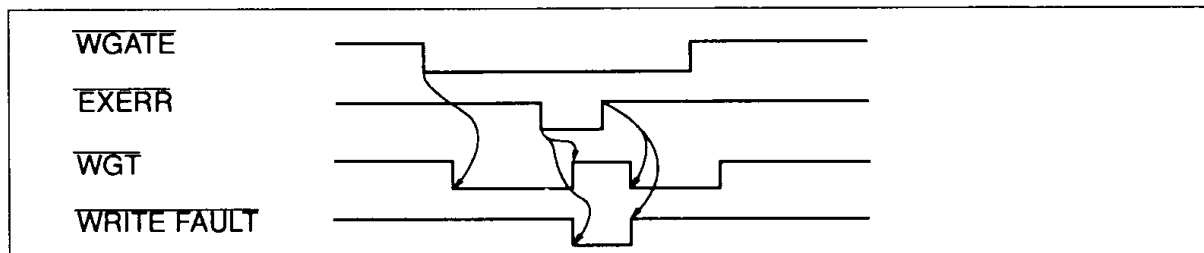

Figure 10  $\overline{\text{WGATE}}, \overline{\text{EXERR}} \rightarrow \overline{\text{WRITE FAULT}}, \overline{\text{WGT}}$

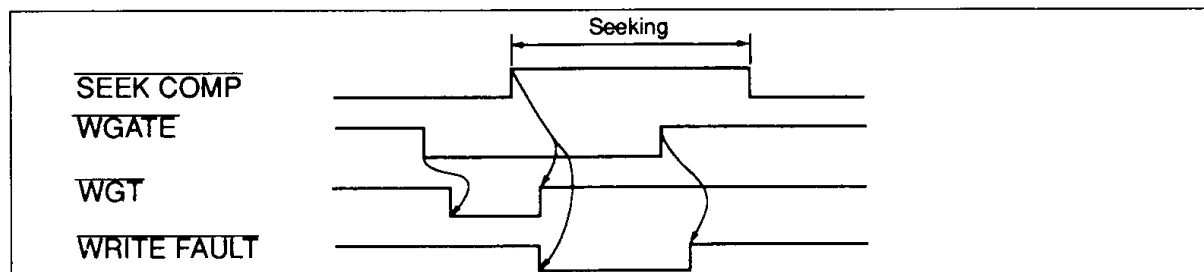

Figure 11  $\overline{\text{WGATE}} \text{ (Seeking)} \rightarrow \overline{\text{WRITE FAULT}}, \overline{\text{WGT}}$

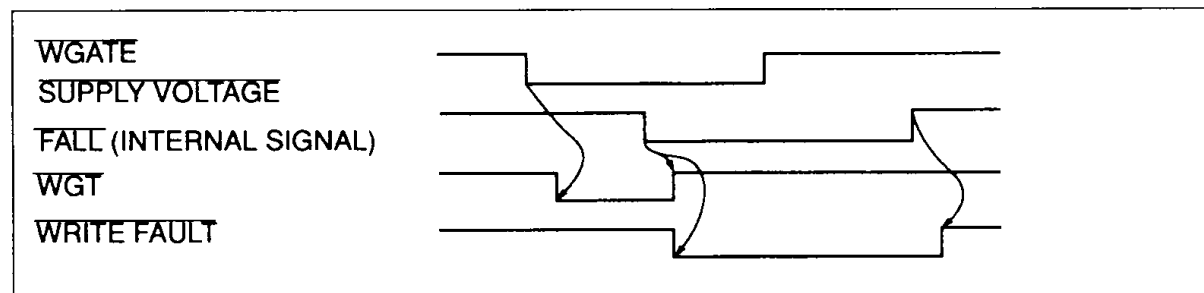

Figure 12 Low Supply Voltage  $\rightarrow \overline{\text{WRITE FAULT}}, \overline{\text{WGT}}$

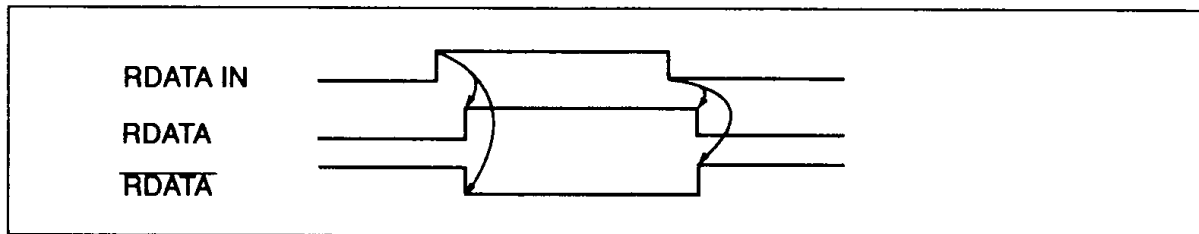

Figure 13 RDATA IN → RDATA,  $\overline{\text{RDATA}}$

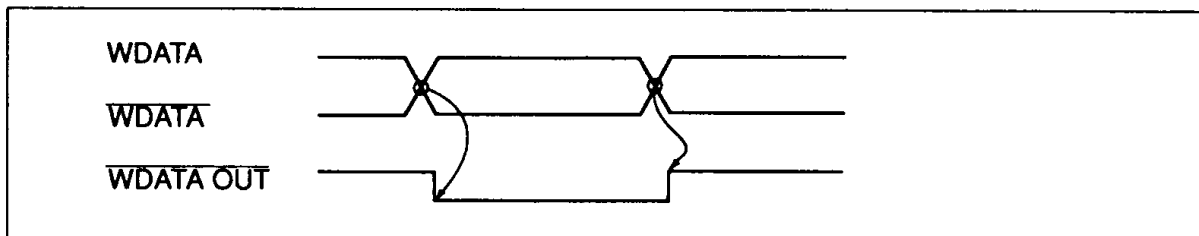

Figure 14 WDATA,  $\overline{\text{WDATA}}$  →  $\overline{\text{WDATA OUT}}$

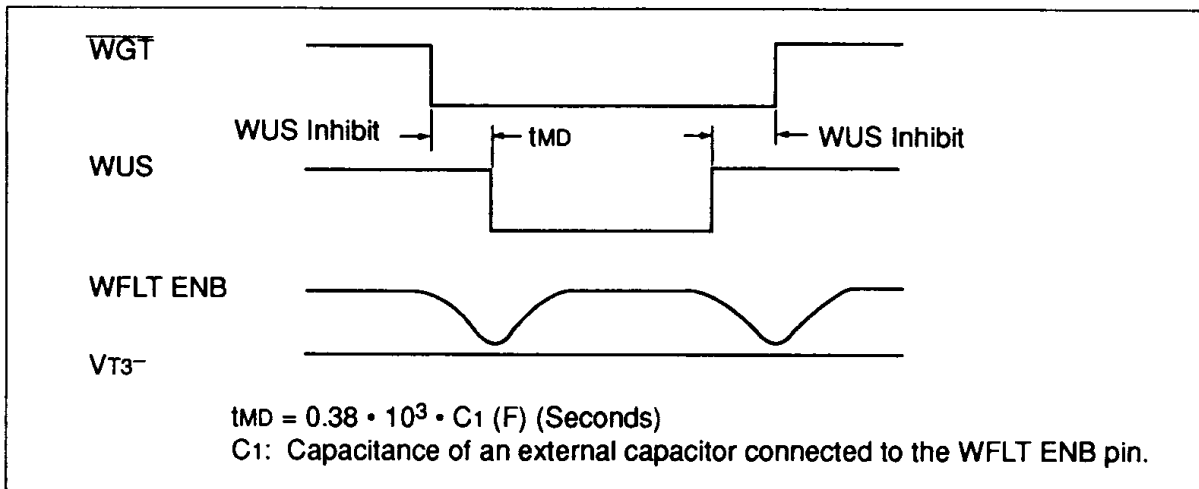

Figure 15 WFLT ENB Timing

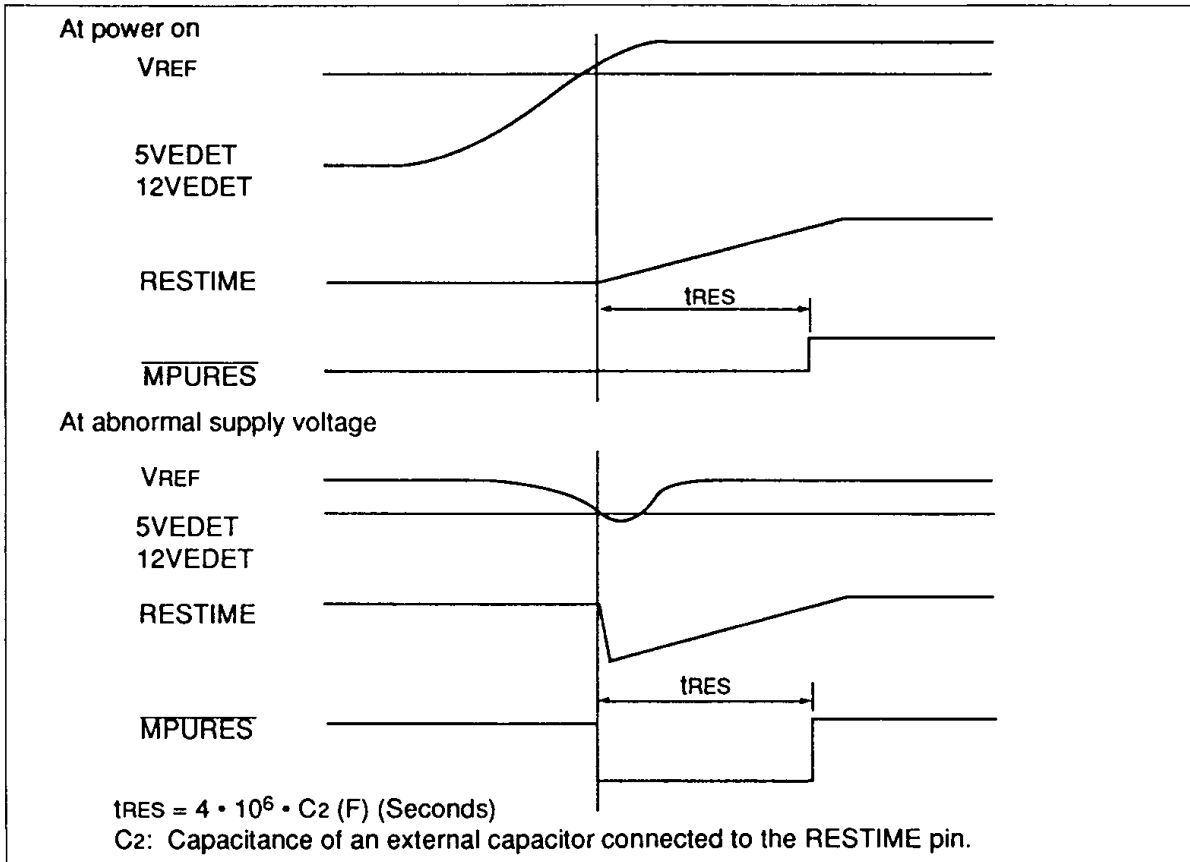

Figure 16 MPU RES Pulse Timing

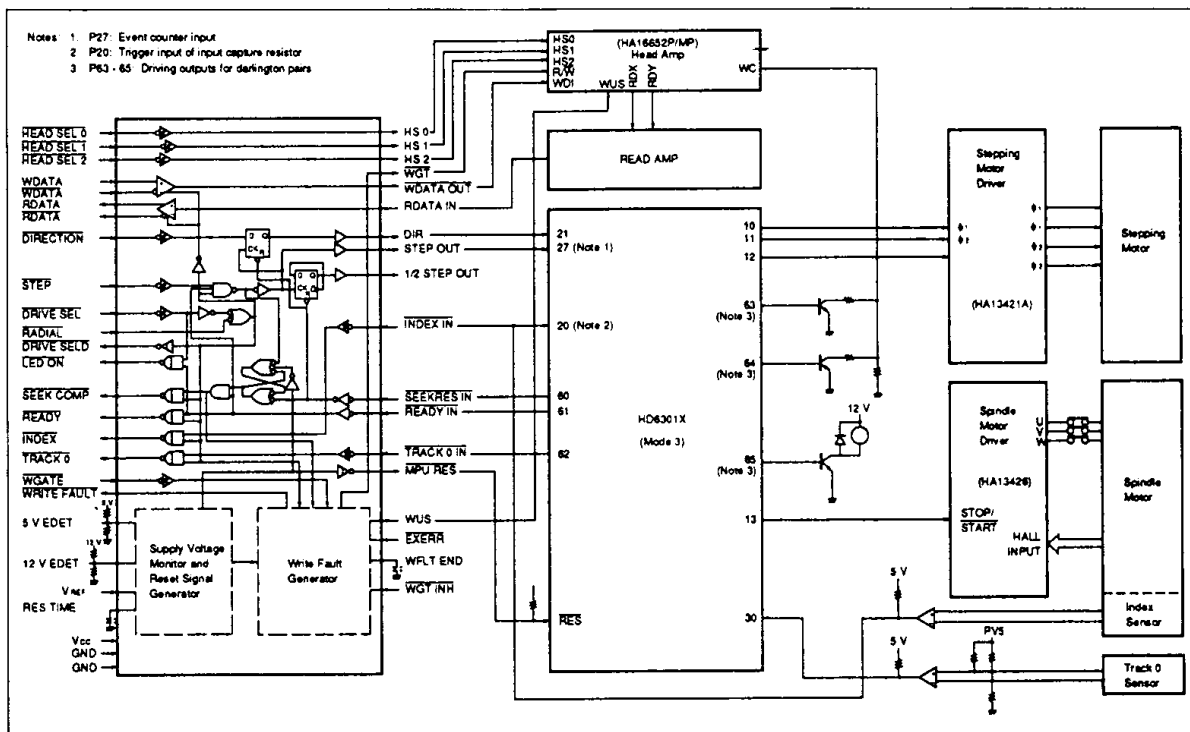

Figure 17 HA16662MP Application Example