HD74ALVCH162836

20-bit Universal Bus Driver with 3-state Outputs

HITACHI

ADE-205-211 (Z)
Preliminary
1st. Edition
January 1998

Description

This 20-bit universal bus driver is designed for 2.3 V to 3.6 V V_{CC} operation.

Data flow from A to Y is controlled by the output enable (\overline{OE}) input. The device operates in the transparent mode when the latch enable (\overline{LE}) input is low. When \overline{LE} is high, the A data is latched if the clock (CLK) input is held at a high or low logic level. If \overline{LE} is high, the A data is stored in the latch flip flop on the low to high transition of CLK. When \overline{OE} is high, the outputs are in the high impedance state.

To ensure the high impedance state during power up or power down, \overline{OE} should be tied to V_{CC} through a pullup resistor; the minimum value of the resistor is determined by the current sinking capability of the driver.

Active bus hold circuitry is provided to hold unused or floating data inputs at a valid logic level.

All outputs, which are designed to sink up to 12 mA, include 26 Ω resistors to reduce overshoot and undershoot.

Features

- $V_{CC} = 2.3 \text{ V to } 3.6 \text{ V}$
- Typical V_{OL} ground bounce $< 0.8 \text{ V}$ (@ $V_{CC} = 3.3 \text{ V}$, $T_a = 25^\circ\text{C}$)
- Typical V_{OH} undershoot $> 2.0 \text{ V}$ (@ $V_{CC} = 3.3 \text{ V}$, $T_a = 25^\circ\text{C}$)
- High output current $\pm 12 \text{ mA}$ (@ $V_{CC} = 3.0 \text{ V}$)
- Bus hold on data inputs eliminates the need for external pullup / pulldown resistors
- All outputs have equivalent 26 Ω series resistors, so no external resistors are required.

Function Table

Inputs				Output Y
\overline{OE}	\overline{LE}	CLK	A	
H	X	X	X	Z
L	L	X	L	L
L	L	X	H	H
L	H	↑	L	L
L	H	↑	H	H
L	H	L or H	X	Y_0^{-1}

H : High level

L : Low level

X : Immaterial

Z : High impedance

↑ : Low to high transition

Note: 1. Output level before the indicated steady state input conditions were established.

Pin Arrangement

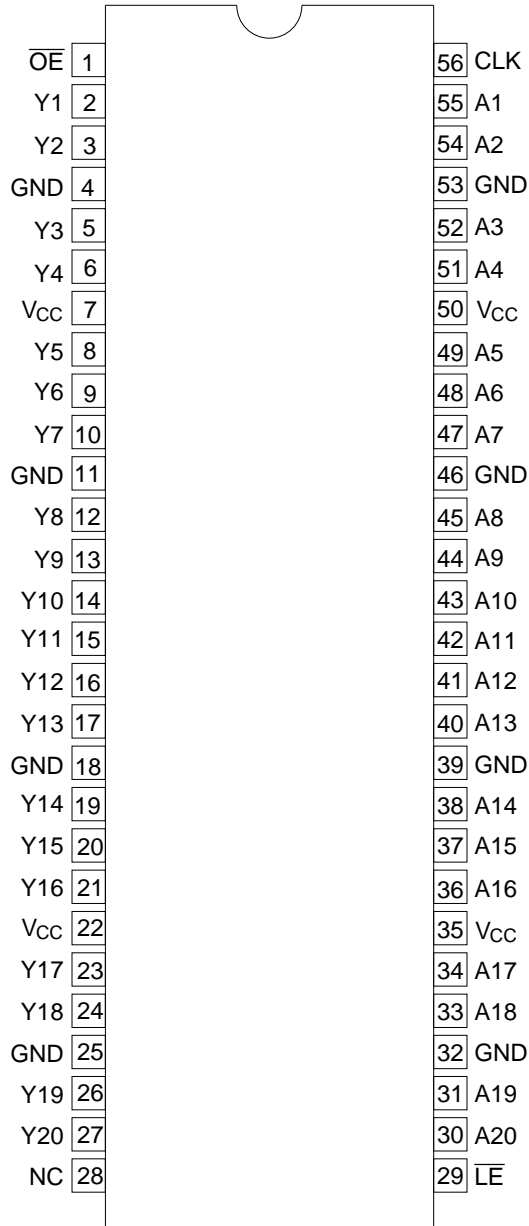

(Top view)

Absolute Maximum Ratings

Item	Symbol	Ratings	Unit	Conditions
Supply voltage	V_{CC}	-0.5 to 4.6	V	
Input voltage ¹	V_I	-0.5 to 4.6	V	
Output voltage ^{1,2}	V_O	-0.5 to $V_{CC} + 0.5$	V	
Input clamp current	I_{IK}	-50	mA	$V_I < 0$
Output clamp current	I_{OK}	± 50	mA	$V_O < 0$ or $V_O > V_{CC}$
Continuous output current	I_O	± 50	mA	$V_O = 0$ to V_{CC}
V_{CC} , GND current / pin	I_{CC} or I_{GND}	± 100	mA	
Maximum power dissipation at $T_a = 55^\circ\text{C}$ (in still air) ³	P_T	1	W	TSSOP
Storage temperature	T_{stg}	-65 to 150	$^\circ\text{C}$	

Notes: Stresses beyond those listed under "absolute maximum ratings" may cause permanent damage to the device. These are stress ratings only, and functional operation of the device at these or any other conditions beyond those indicated under "recommended operating conditions" is not implied. Exposure to absolute maximum rated conditions for extended periods may affect device reliability.

1. The input and output negative voltage ratings may be exceeded if the input and output clamp current ratings are observed.
2. This value is limited to 4.6 V maximum.
3. The maximum package power dissipation is calculated using a junction temperature of 150°C and a board trace length of 750 mils.

Recommended Operating Conditions

Item	Symbol	Min	Max	Unit	Conditions
Supply voltage	V_{CC}	2.3	3.6	V	
Input voltage	V_I	0	V_{CC}	V	
Output voltage	V_O	0	V_{CC}	V	
High level output current	I_{OH}	—	-6	mA	$V_{CC} = 2.3\text{ V}$
		—	-8		$V_{CC} = 2.7\text{ V}$
		—	-12		$V_{CC} = 3.0\text{ V}$
Low level output current	I_{OL}	—	6	mA	$V_{CC} = 2.3\text{ V}$
		—	8		$V_{CC} = 2.7\text{ V}$
		—	12		$V_{CC} = 3.0\text{ V}$
Input transition rise or fall rate	$\Delta t / \Delta v$	0	10	ns / V	
Operating temperature	T_a	-40	85	$^\circ\text{C}$	

Note: Unused control inputs must be held high or low to prevent them from floating.

Logic Diagram

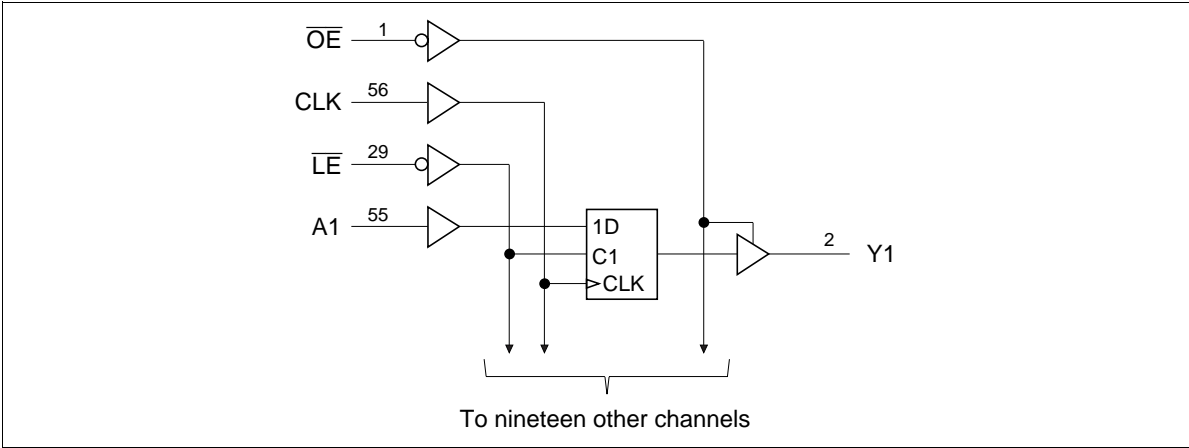

HD74ALVCH162836

Electrical Characteristics (Ta = -40 to 85°C)

Item	Symbol	V _{CC} (V)	Min	Max	Unit	Test Conditions			
Input voltage	V _{IH}	2.3 to 2.7	1.7	—	V				
		2.7 to 3.6	2.0	—					
	V _{IL}	2.3 to 2.7	—	0.7					
		2.7 to 3.6	—	0.8					
Output voltage	V _{OH}	2.3 to 3.6	V _{CC} -0.2	—	V	I _{OH} = -100 μA			
		2.3	1.9	—		I _{OH} = -4 mA, V _{IH} = 1.7 V			
		2.3	1.7	—		I _{OH} = -6 mA, V _{IH} = 1.7 V			
		3.0	2.4	—		I _{OH} = -6 mA, V _{IH} = 2.0 V			
		2.7	2.0	—		I _{OH} = -8 mA, V _{IH} = 2.0 V			
		3.0	2.0	—		I _{OH} = -12 mA, V _{IH} = 2.0 V			
	V _{OL}	2.3 to 3.6	—	0.2		I _{OL} = 100 μA			
		2.3	—	0.4		I _{OL} = 4 mA, V _{IL} = 0.7 V			
		2.3	—	0.55		I _{OL} = 6 mA, V _{IL} = 0.7 V			
		3.0	—	0.55		I _{OL} = 6 mA, V _{IL} = 0.8 V			
		2.7	—	0.6		I _{OL} = 8 mA, V _{IL} = 0.8 V			
		3.0	—	0.8		I _{OL} = 12 mA, V _{IL} = 0.8 V			
		Input current	I _{IN}	3.6		—	±5	μA	V _{IN} = V _{CC} or GND
				I _{IN (hold)}		2.3	45		—
2.3	-45				—	V _{IN} = 1.7 V			
3.0	75				—	V _{IN} = 0.8 V			
3.0	-75				—	V _{IN} = 2.0 V			
3.6	—				±500	V _{IN} = 0 to 3.6 V ⁻¹			
Off state output current	I _{OZ}	3.6	—	±10	μA	V _{OUT} = V _{CC} or GND			
Quiescent supply current	I _{CC}	3.6	—	40	μA	V _{IN} = V _{CC} or GND			
	ΔI _{CC}	3.0 to 3.6	—	750	μA	V _{IN} = one input at (V _{CC} -0.6) V, other inputs at V _{CC} or GND			

Note: 1. This is the bus hold maximum dynamic current required to switch the input from one state to another.

Switching Characteristics (Ta = -40 to 85°C)

Item	Symbol	V _{cc} (V)	Min	Typ	Max	Unit	FROM (Input)	TO (Output)
Maximum clock frequency	f _{max}	2.5±0.2	150	—	—	MHz		
		2.7	150	—	—			
		3.3±0.3	150	—	—			
Propagation delay time	t _{PLH}	2.5±0.2	1.0	—	3.8	ns	A	Y
		2.7	—	—	4.6			
		3.3±0.3	1.2	—	4.0			
	t _{PHL}	2.5±0.2	1.1	—	4.9		\overline{LE}	Y
		2.7	—	—	6.1			
		3.3±0.3	1.4	—	5.1			
	t _{PHL}	2.5±0.2	1.0	—	4.5		CLK	Y
		2.7	—	—	5.5			
		3.3±0.3	1.1	—	5.0			
Output enable time	t _{ZH}	2.5±0.2	1.1	—	5.5	ns	\overline{OE}	Y
		2.7	—	—	6.5			
		3.3±0.3	1.2	—	5.5			
Output disable time	t _{ZL}	2.5±0.2	1.0	—	4.2	ns	\overline{OE}	Y
		2.7	—	—	5.2			
		3.3±0.3	1.7	—	5.1			
Input capacitance	C _{IN}	3.3	—	5.5	—	pF	Control inputs	
		3.3	—	6.0	—		Data inputs	
Output capacitance	C _O	3.3	—	8.0	—	pF	Outputs	

Switching Characteristics (Ta = -40 to 85°C) (cont)

Item	Symbol	V _{CC} (V)	Min	Typ	Max	Unit	FROM (Input)
Setup time	t _{su}	2.5±0.2	1.4	—	—	ns	Data before CLK↑
		2.7	1.7	—	—		
		3.3±0.3	1.5	—	—		
		2.5±0.2	1.2	—	—		Data before $\overline{\text{LE}}\uparrow$ CLK "H"
		2.7	1.6	—	—		
		3.3±0.3	1.3	—	—		
		2.5±0.2	1.4	—	—		Data before $\overline{\text{LE}}\uparrow$ CLK "L"
		2.7	1.5	—	—		
		3.3±0.3	1.2	—	—		
Hold time	t _h	2.5±0.2	0.9	—	—	ns	Data after CLK↑
		2.7	0.9	—	—		
		3.3±0.3	0.9	—	—		
		2.5±0.2	1.1	—	—		Data after $\overline{\text{LE}}\uparrow$ CLK "H" or "L"
		2.7	1.1	—	—		
		3.3±0.3	1.1	—	—		
Pulse width	t _w	2.5±0.2	3.3	—	—	ns	$\overline{\text{LE}}$ "L"
		2.7	3.3	—	—		
		3.3±0.3	3.3	—	—		
		2.5±0.2	3.3	—	—		CLK "H" or "L"
		2.7	3.3	—	—		
		3.3±0.3	3.3	—	—		

Test Circuit

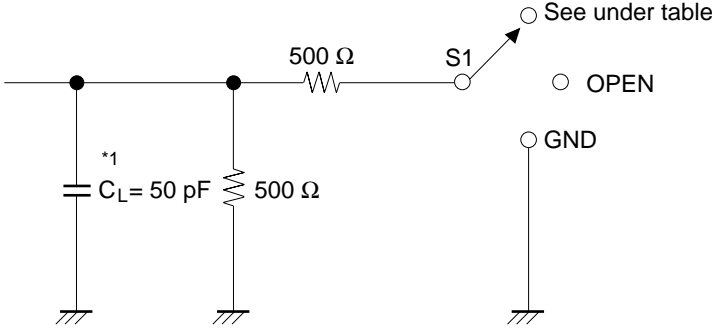

Load Circuit for Outputs

Symbol	V _{CC} =2.5±0.2V	V _{CC} =2.7V, 3.3±0.3V
t _{PLH} /t _{PHL}	OPEN	OPEN
t _{su} /t _h /t _w	OPEN	OPEN
t _{ZH} /t _{HZ}	GND	GND
t _{ZL} /t _{LZ}	2 × V _{CC}	6.0 V

Note: 1. C_L includes probe and jig capacitance.

Waveforms – 1

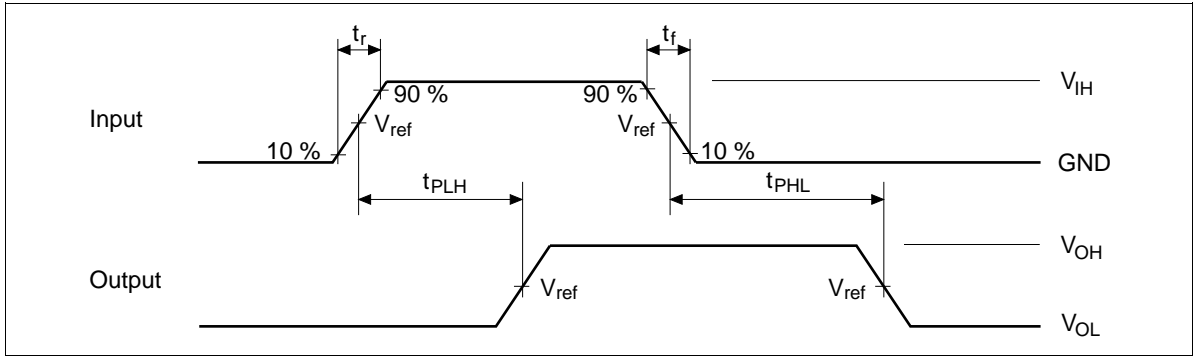

Waveforms – 2

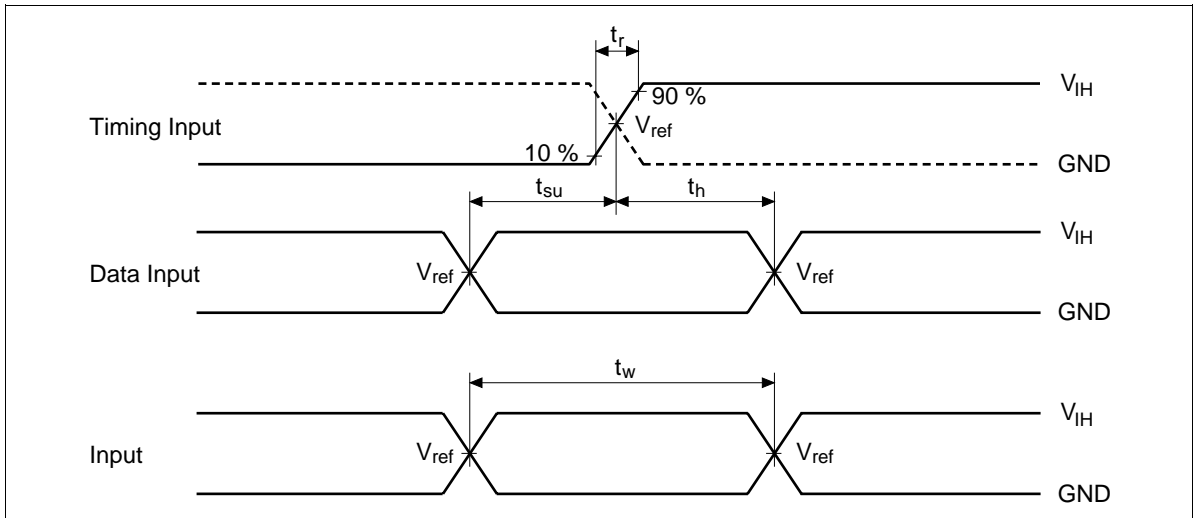

Waveforms – 3

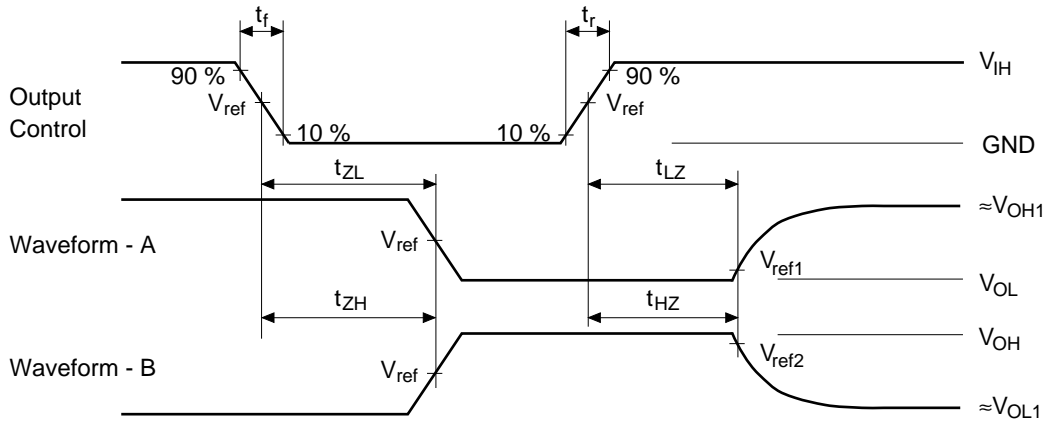

TEST	$V_{CC}=2.5\pm0.2V$	$V_{CC}=2.7V, 3.3\pm0.3V$
V_{IH}	V_{CC}	2.7 V
V_{ref}	$1/2 V_{CC}$	1.5 V
V_{ref1}	$V_{OL} + 0.15 V$	$V_{OL} + 0.3 V$
V_{ref2}	$V_{OH} - 0.15 V$	$V_{OH} - 0.3 V$
V_{OH1}	V_{CC}	3.0 V
V_{OL1}	GND	GND

- Notes:
1. All input pulses are supplied by generators having the following characteristics :
 $PRR \leq 10 \text{ MHz}$, $Z_o = 50 \Omega$, $t_r \leq 2.0 \text{ ns}$, $t_f \leq 2.0 \text{ ns}$. ($V_{CC} = 2.5\pm0.2 \text{ V}$)
 $PRR \leq 10 \text{ MHz}$, $Z_o = 50 \Omega$, $t_r \leq 2.5 \text{ ns}$, $t_f \leq 2.5 \text{ ns}$. ($V_{CC} = 2.7 \text{ V}, 3.3\pm0.3 \text{ V}$)
 2. Waveform – A is for an output with internal conditions such that the output is low except when disabled by the output control.
 3. Waveform – B is for an output with internal conditions such that the output is high except when disabled by the output control.
 4. The output are measured one at a time with one transition per measurement.

HD74ALVCH162836

Package Dimensions

Unit : mm

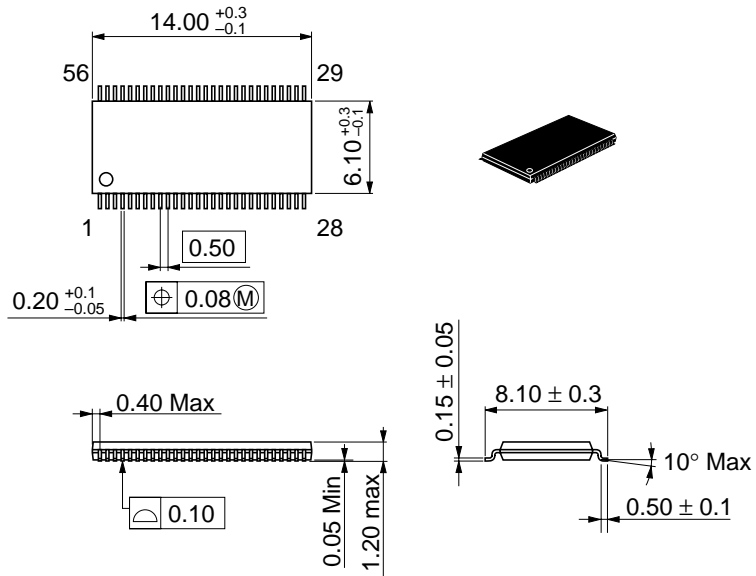

Hitachi code	TTP-56D
EIAJ code	—
JEDEC code	—

Cautions

1. Hitachi neither warrants nor grants licenses of any rights of Hitachi's or any third party's patent, copyright, trademark, or other intellectual property rights for information contained in this document. Hitachi bears no responsibility for problems that may arise with third party's rights, including intellectual property rights, in connection with use of the information contained in this document.
2. Products and product specifications may be subject to change without notice. Confirm that you have received the latest product standards or specifications before final design, purchase or use.
3. Hitachi makes every attempt to ensure that its products are of high quality and reliability. However, contact Hitachi's sales office before using the product in an application that demands especially high quality and reliability or where its failure or malfunction may directly threaten human life or cause risk of bodily injury, such as aerospace, aeronautics, nuclear power, combustion control, transportation, traffic, safety equipment or medical equipment for life support.
4. Design your application so that the product is used within the ranges guaranteed by Hitachi particularly for maximum rating, operating supply voltage range, heat radiation characteristics, installation conditions and other characteristics. Hitachi bears no responsibility for failure or damage when used beyond the guaranteed ranges. Even within the guaranteed ranges, consider normally foreseeable failure rates or failure modes in semiconductor devices and employ systemic measures such as fail-safes, so that the equipment incorporating Hitachi product does not cause bodily injury, fire or other consequential damage due to operation of the Hitachi product.
5. This product is not designed to be radiation resistant.
6. No one is permitted to reproduce or duplicate, in any form, the whole or part of this document without written approval from Hitachi.
7. Contact Hitachi's sales office for any questions regarding this document or Hitachi semiconductor products.

HITACHI

Hitachi, Ltd.

Semiconductor & Integrated Circuits.
Nippon Bldg., 2-6-2, Ohte-machi, Chiyoda-ku, Tokyo 100-0004, Japan
Tel: Tokyo (03) 3270-2111 Fax: (03) 3270-5109

URL North America : <http://semiconductor.hitachi.com/>
 Europe : <http://www.hitachi-eu.com/hel/ecg>
 Asia (Singapore) : <http://www.has.hitachi.com.sg/grp3/sicd/index.htm>
 Asia (Taiwan) : http://www.hitachi.com.tw/E/Product/SICD_Frame.htm
 Asia (HongKong) : <http://www.hitachi.com.hk/eng/bo/grp3/index.htm>
 Japan : <http://www.hitachi.co.jp/Sicd/indx.htm>

For further information write to:

Hitachi Semiconductor
(America) Inc.
179 East Tasman Drive,
San Jose, CA 95134
Tel: <1> (408) 433-1990
Fax: <1>(408) 433-0223

Hitachi Europe GmbH
Electronic components Group
Dornacher Straße 3
D-85622 Feldkirchen, Munich
Germany
Tel: <49> (89) 9 9180-0
Fax: <49> (89) 9 29 30 00

Hitachi Europe Ltd.
Electronic Components Group.
Whitebrook Park
Lower Cookham Road
Maidenhead
Berkshire SL6 8YA, United Kingdom
Tel: <44> (1628) 585000
Fax: <44> (1628) 778322

Hitachi Asia Pte. Ltd.
16 Collyer Quay #20-00
Hitachi Tower
Singapore 049318
Tel: 535-2100
Fax: 535-1533

Hitachi Asia Ltd.
Taipei Branch Office
3F, Hung Kuo Building, No.167,
Tun-Hwa North Road, Taipei (105)
Tel: <886> (2) 2718-3666
Fax: <886> (2) 2718-8180

Hitachi Asia (Hong Kong) Ltd.
Group III (Electronic Components)
7/F., North Tower, World Finance Centre,
Harbour City, Canton Road, Tsim Sha Tsui,
Kowloon, Hong Kong
Tel: <852> (2) 735 9218
Fax: <852> (2) 730 0281
Telex: 40815 HITEC HX

Copyright ' Hitachi, Ltd., 1999. All rights reserved. Printed in Japan.

HITACHI