



HER101 THRU HER108

HIGH EFFICIENT SILICON RECTIFIER

Reverse Voltage - 50 to 1000 Volts Forward Current - 1.0 Ampere

FEATURES

- The plastic package carries Underwriters Laboratory Flammability Classification 94V-0
- Ultra fast switching for high efficiency
- Low reverse leakage
- High forward surge current capability
- High temperature soldering guaranteed:
250°C/10 seconds, 0.375" (9.5mm) lead length,
5 lbs. (2.3kg) tension

MECHANICAL DATA

Case: JEDEC DO-41 molded plastic body

Terminals: Plated axial leads, solderable per MIL-STD-750, Method 2026

Polarity: Color band denotes cathode end

Mounting Position: Any

Weight: 0.012 ounce, 0.33 grams

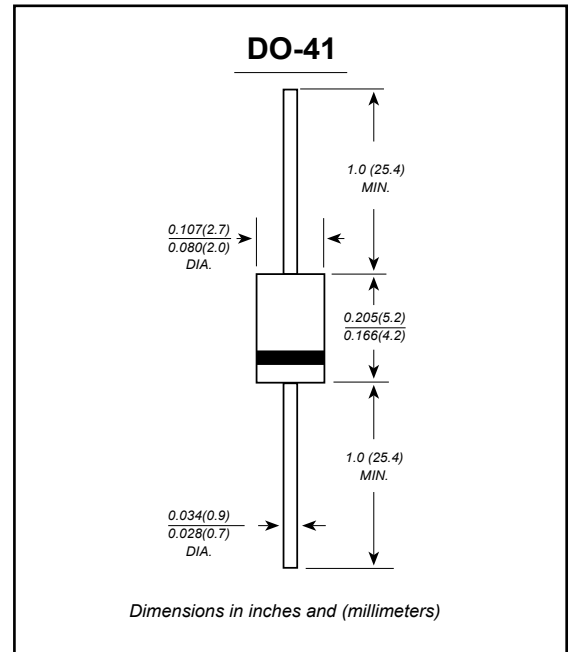

MAXIMUM RATINGS AND ELECTRICAL CHARACTERISTICS

Ratings at 25°C ambient temperature unless otherwise specified.

Single phase half-wave 60Hz, resistive or inductive load, for capacitive load current derate by 20%.

Characteristic	Symbol	HER 101	HER 102	HER 103	HER 104	HER 105	HER 106	HER 107	HER 108	Unit	
Peak Repetitive Reverse Voltage	V_{RRM}										
Working Peak Reverse Voltage	V_{RWM}	50	100	200	300	400	600	800	1000	V	
DC Blocking Voltage	V_R										
RMS Reverse Voltage	$V_{R(RMS)}$	35	70	140	210	280	420	560	700	V	
Average Rectified Output Current (Note 1) @ $T_A = 55^\circ\text{C}$	I_o	1.0								A	
Non-Repetitive Peak Forward Surge Current 8.3ms Single half sine-wave superimposed on rated load (JEDEC Method)	I_{FSM}	30								A	
Forward Voltage @ $I_F = 1.0\text{A}$	V_{FM}	1.0			1.3		1.7			V	
Peak Reverse Current @ $T_A = 25^\circ\text{C}$ At Rated DC Blocking Voltage @ $T_A = 100^\circ\text{C}$	I_{RM}	5.0					100				μA
Reverse Recovery Time (Note 2)	t_{rr}	50					75				nS
Typical Junction Capacitance (Note 3)	C_j	20					15				pF
Operating Temperature Range	T_j	-65 to +150								$^\circ\text{C}$	
Storage Temperature Range	T_{STG}	-65 to +150								$^\circ\text{C}$	

Note: 1. Leads maintained at ambient temperature at a distance of 9.5mm from the case

2. Measured with $I_F = 0.5\text{A}$, $I_R = 1.0\text{A}$, $IRR = 0.25\text{A}$. See figure 5.

3. Measured at 1.0 MHz and applied reverse voltage of 4.0V D.C.



HER101 THRU HER108

RATINGS AND CHARACTERISTIC CURVES

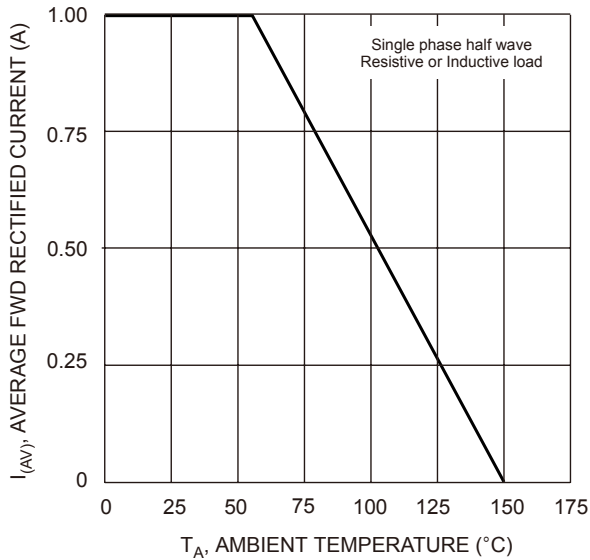

Fig. 1 Forward Current Derating Curve

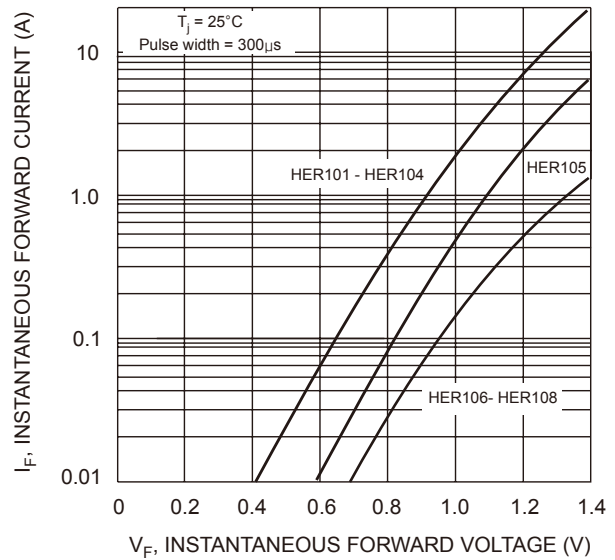

Fig. 2 Typical Forward Characteristics

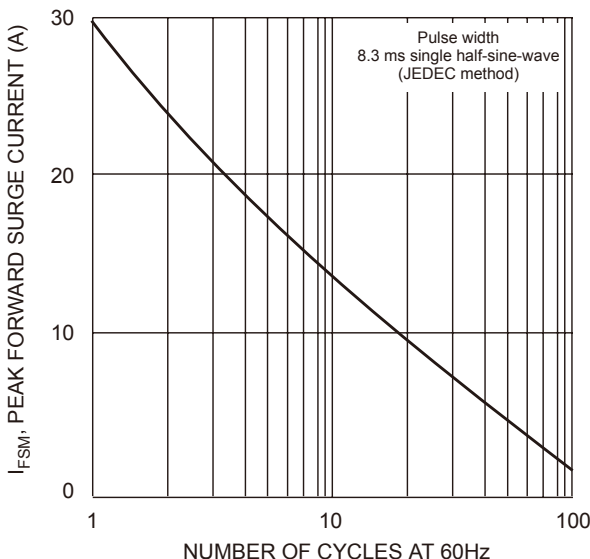

Fig. 3 Peak Forward Surge Current

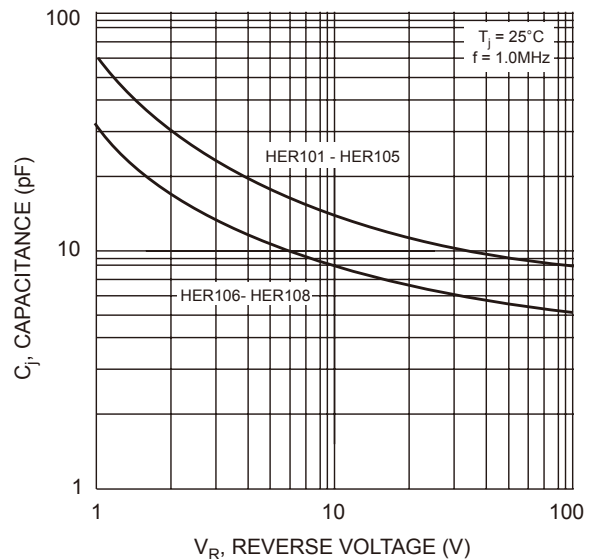
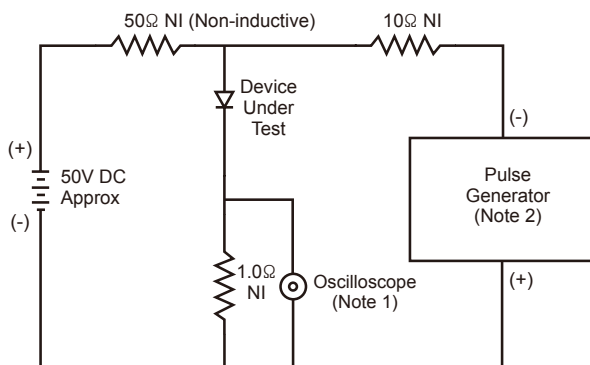
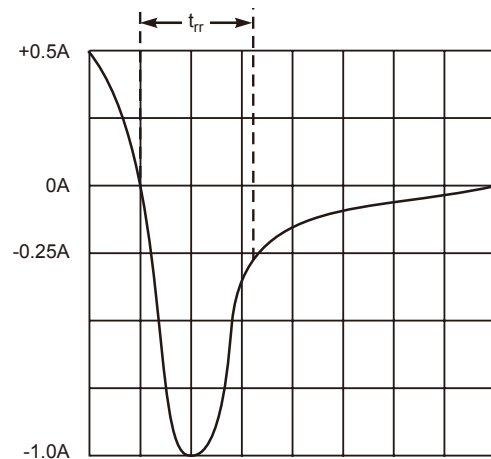

Fig. 4 Typical Junction Capacitance



- Notes:
1. Rise Time = 7.0ns max. Input Impedance = 1.0M Ω , 22pF.
 2. Rise Time = 10ns max. Input Impedance = 50 Ω .



Set time base for 5/10ns/cm

Fig. 5 Reverse Recovery Time Characteristic and Test Circuit