

### 600V, SMPS Series N-Channel IGBT

The HGTG40N60A4 is a MOS gated high voltage switching device combining the best features of a MOSFET and a bipolar transistor. This device has the high input impedance of a MOSFET and the low on-state conduction loss of a bipolar transistor. The much lower on-state voltage drop varies only moderately between 25°C and 150°C. This IGBT is ideal for many high voltage switching applications operating at high frequencies where low conduction losses are essential. This device has been optimized for high frequency switch mode power supplies.

Formerly Developmental Type TA49347.

### Ordering Information

| PART NUMBER | PACKAGE | BRAND   |
|-------------|---------|---------|
| HGTG40N60A4 | TO-247  | 40N60A4 |

NOTE: When ordering, use the entire part number.

### Symbol

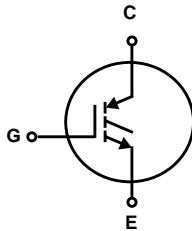

### Features

- 100kHz Operation At 390V, 40A
- 200kHz Operation At 390V, 20A
- 600V Switching SOA Capability
- Typical Fall Time . . . . . 55ns at  $T_J = 125^\circ$
- Low Conduction Loss

### Packaging

JEDEC STYLE TO-247

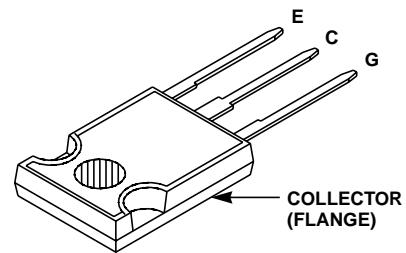

**INTERSIL CORPORATION IGBT PRODUCT IS COVERED BY ONE OR MORE OF THE FOLLOWING U.S. PATENTS**

|           |           |           |           |           |           |           |           |
|-----------|-----------|-----------|-----------|-----------|-----------|-----------|-----------|
| 4,364,073 | 4,417,385 | 4,430,792 | 4,443,931 | 4,466,176 | 4,516,143 | 4,532,534 | 4,587,713 |
| 4,598,461 | 4,605,948 | 4,620,211 | 4,631,564 | 4,639,754 | 4,639,762 | 4,641,162 | 4,644,637 |
| 4,682,195 | 4,684,413 | 4,694,313 | 4,717,679 | 4,743,952 | 4,783,690 | 4,794,432 | 4,801,986 |
| 4,803,533 | 4,809,045 | 4,809,047 | 4,810,665 | 4,823,176 | 4,837,606 | 4,860,080 | 4,883,767 |
| 4,888,627 | 4,890,143 | 4,901,127 | 4,904,609 | 4,933,740 | 4,963,951 | 4,969,027 |           |

# HGTG40N60A4

## Absolute Maximum Ratings $T_C = 25^\circ\text{C}$ , Unless Otherwise Specified

|                                                                                 | HGTG40N60A4    | UNITS                       |
|---------------------------------------------------------------------------------|----------------|-----------------------------|
| Collector to Emitter Voltage . . . . .                                          | $BV_{CES}$     | 600 V                       |
| Collector Current Continuous                                                    |                |                             |
| At $T_C = 25^\circ\text{C}$ . . . . .                                           | $I_{C25}$      | 75 A                        |
| At $T_C = 110^\circ\text{C}$ . . . . .                                          | $I_{C110}$     | 63 A                        |
| Collector Current Pulsed (Note 1) . . . . .                                     | $I_{CM}$       | 300 A                       |
| Gate to Emitter Voltage Continuous . . . . .                                    | $V_{GES}$      | $\pm 20$ V                  |
| Gate to Emitter Voltage Pulsed . . . . .                                        | $V_{GEM}$      | $\pm 30$ V                  |
| Switching Safe Operating Area at $T_J = 150^\circ\text{C}$ , Figure 2 . . . . . | SSOA           | 200A at 600V                |
| Power Dissipation Total at $T_C = 25^\circ\text{C}$ . . . . .                   | $P_D$          | 625 W                       |
| Power Dissipation Derating $T_C > 25^\circ\text{C}$ . . . . .                   |                | 5 W/ $^\circ\text{C}$       |
| Operating and Storage Junction Temperature Range . . . . .                      | $T_J, T_{STG}$ | -55 to 150 $^\circ\text{C}$ |
| Maximum Lead Temperature for Soldering . . . . .                                | $T_L$          | 260 $^\circ\text{C}$        |

CAUTION: Stresses above those listed in "Absolute Maximum Ratings" may cause permanent damage to the device. This is a stress only rating and operation of the device at these or any other conditions above those indicated in the operational sections of this specification is not implied.

### NOTE:

1. Pulse width limited by maximum junction temperature.

## Electrical Specifications $T_J = 25^\circ\text{C}$ , Unless Otherwise Specified

| PARAMETER                               | SYMBOL        | TEST CONDITIONS                                                                                                                                                                                   | MIN                       | TYP | MAX       | UNITS         |               |
|-----------------------------------------|---------------|---------------------------------------------------------------------------------------------------------------------------------------------------------------------------------------------------|---------------------------|-----|-----------|---------------|---------------|
| Collector to Emitter Breakdown Voltage  | $BV_{CES}$    | $I_C = 250\mu\text{A}, V_{GE} = 0\text{V}$                                                                                                                                                        | 600                       | -   | -         | V             |               |
| Emitter to Collector Breakdown Voltage  | $BV_{ECS}$    | $I_C = 10\text{mA}, V_{GE} = 0\text{V}$                                                                                                                                                           | 20                        | -   | -         |               |               |
| Collector to Emitter Leakage Current    | $I_{CES}$     | $V_{CE} = BV_{CES}$                                                                                                                                                                               | $T_J = 25^\circ\text{C}$  | -   | -         | 250           | $\mu\text{A}$ |
|                                         |               |                                                                                                                                                                                                   | $T_J = 125^\circ\text{C}$ | -   | -         | 3.0           | mA            |
| Collector to Emitter Saturation Voltage | $V_{CE(SAT)}$ | $I_C = 40\text{A}, V_{GE} = 15\text{V}$                                                                                                                                                           | $T_J = 25^\circ\text{C}$  | -   | 1.7       | 2.7           | V             |
|                                         |               |                                                                                                                                                                                                   | $T_J = 125^\circ\text{C}$ | -   | 1.5       | 2.0           | V             |
| Gate to Emitter Threshold Voltage       | $V_{GE(TH)}$  | $I_C = 250\mu\text{A}, V_{CE} = V_{GE}$                                                                                                                                                           | 4.5                       | 5.6 | 7         | V             |               |
| Gate to Emitter Leakage Current         | $I_{GES}$     | $V_{GE} = \pm 20\text{V}$                                                                                                                                                                         | -                         | -   | $\pm 250$ | nA            |               |
| Switching SOA                           | SSOA          | $T_J = 150^\circ\text{C}, R_G = 2.2\Omega, V_{GE} = 15\text{V}$<br>$L = 100\mu\text{H}, V_{CE} = 600\text{V}$                                                                                     | 200                       | -   | -         | A             |               |
| Gate to Emitter Plateau Voltage         | $V_{GEP}$     | $I_C = 40\text{A}, V_{CE} = 0.5 BV_{CES}$                                                                                                                                                         | -                         | 8.5 | -         | V             |               |
| On-State Gate Charge                    | $Q_{g(ON)}$   | $I_C = 40\text{A}, V_{CE} = 0.5 BV_{CES}$                                                                                                                                                         | $V_{GE} = 15\text{V}$     | -   | 350       | 405           | nC            |
|                                         |               |                                                                                                                                                                                                   | $V_{GE} = 20\text{V}$     | -   | 450       | 520           | nC            |
| Current Turn-On Delay Time              | $t_{d(ON)I}$  | IGBT and Diode at $T_J = 25^\circ\text{C}$<br>$I_{CE} = 40\text{A}$<br>$V_{CE} = 0.65 BV_{CES}$<br>$V_{GE} = 15\text{V}$<br>$R_G = 2.2\Omega$<br>$L = 200\mu\text{H}$<br>Test Circuit (Figure 20) | -                         | 25  | -         | ns            |               |
| Current Rise Time                       | $t_{rI}$      |                                                                                                                                                                                                   | -                         | 18  | -         | ns            |               |
| Current Turn-Off Delay Time             | $t_{d(OFF)I}$ |                                                                                                                                                                                                   | -                         | 145 | -         | ns            |               |
| Current Fall Time                       | $t_{fI}$      |                                                                                                                                                                                                   | -                         | 35  | -         | ns            |               |
| Turn-On Energy (Note 3)                 | $E_{ON1}$     |                                                                                                                                                                                                   | -                         | 400 | -         | $\mu\text{J}$ |               |
| Turn-On Energy (Note 3)                 | $E_{ON2}$     |                                                                                                                                                                                                   | -                         | 850 | -         | $\mu\text{J}$ |               |
| Turn-Off Energy (Note 2)                | $E_{OFF}$     |                                                                                                                                                                                                   | -                         | 370 | -         | $\mu\text{J}$ |               |

# HGTG40N60A4

Electrical Specifications  $T_J = 25^\circ\text{C}$ , Unless Otherwise Specified (Continued)

| PARAMETER                           | SYMBOL          | TEST CONDITIONS                                                                                                                                                                                          | MIN | TYP  | MAX  | UNITS              |
|-------------------------------------|-----------------|----------------------------------------------------------------------------------------------------------------------------------------------------------------------------------------------------------|-----|------|------|--------------------|
| Current Turn-On Delay Time          | $t_{d(ON)I}$    | IGBT and Diode at $T_J = 125^\circ\text{C}$<br>$I_{CE} = 40\text{A}$<br>$V_{CE} = 0.65\text{BV}_{CES}$<br>$V_{GE} = 15\text{V}$<br>$R_G = 2.2\Omega$<br>$L = 200\mu\text{H}$<br>Test Circuit (Figure 20) | -   | 27   | -    | ns                 |
| Current Rise Time                   | $t_{rI}$        |                                                                                                                                                                                                          | -   | 20   | -    | ns                 |
| Current Turn-Off Delay Time         | $t_{d(OFF)I}$   |                                                                                                                                                                                                          | -   | 185  | 225  | ns                 |
| Current Fall Time                   | $t_{fI}$        |                                                                                                                                                                                                          | -   | 55   | 95   | ns                 |
| Turn-On Energy (Note 3)             | $E_{ON1}$       |                                                                                                                                                                                                          | -   | 400  | -    | $\mu\text{J}$      |
| Turn-On Energy (Note 3)             | $E_{ON2}$       |                                                                                                                                                                                                          | -   | 1220 | 1400 | $\mu\text{J}$      |
| Turn-Off Energy (Note 2)            | $E_{OFF}$       |                                                                                                                                                                                                          | -   | 700  | 800  | $\mu\text{J}$      |
| Thermal Resistance Junction To Case | $R_{\theta JC}$ |                                                                                                                                                                                                          | -   | -    | 0.2  | $^\circ\text{C/W}$ |

**NOTES:**

- Turn-Off Energy Loss ( $E_{OFF}$ ) is defined as the integral of the instantaneous power loss starting at the trailing edge of the input pulse and ending at the point where the collector current equals zero ( $I_{CE} = 0\text{A}$ ). All devices were tested per JEDEC Standard No. 24-1 Method for Measurement of Power Device Turn-Off Switching Loss. This test method produces the true total Turn-Off Energy Loss.
- Values for two Turn-On loss conditions are shown for the convenience of the circuit designer.  $E_{ON1}$  is the turn-on loss of the IGBT only.  $E_{ON2}$  is the turn-on loss when a typical diode is used in the test circuit and the diode is at the same  $T_J$  as the IGBT. The diode type is specified in Figure 20.

## Typical Performance Curves Unless Otherwise Specified

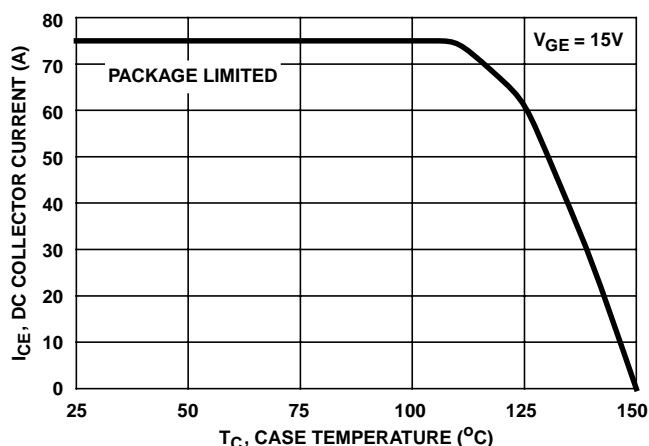

FIGURE 1. DC COLLECTOR CURRENT vs CASE TEMPERATURE

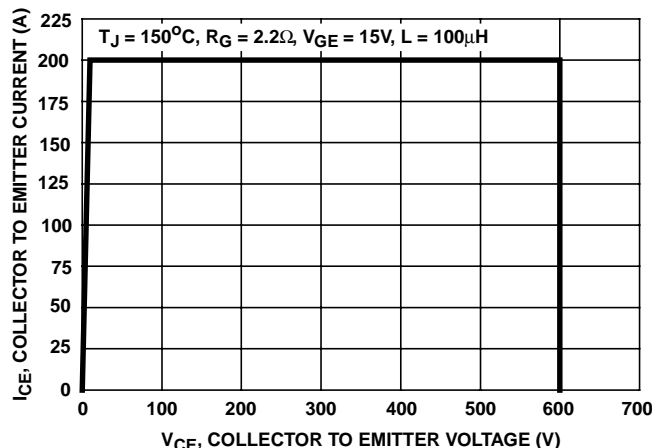

FIGURE 2. MINIMUM SWITCHING SAFE OPERATING AREA

Typical Performance Curves Unless Otherwise Specified (Continued)

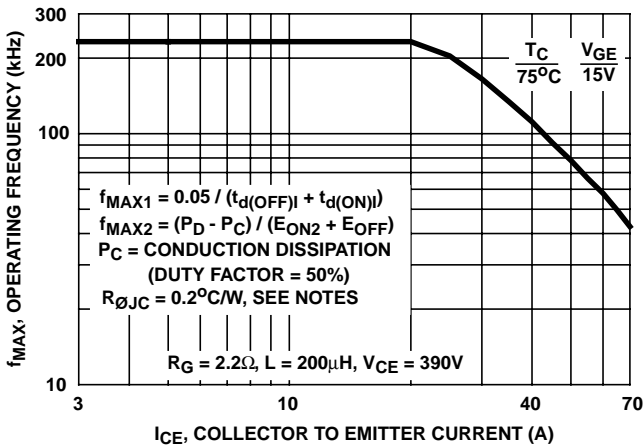

FIGURE 3. OPERATING FREQUENCY vs COLLECTOR TO EMITTER CURRENT

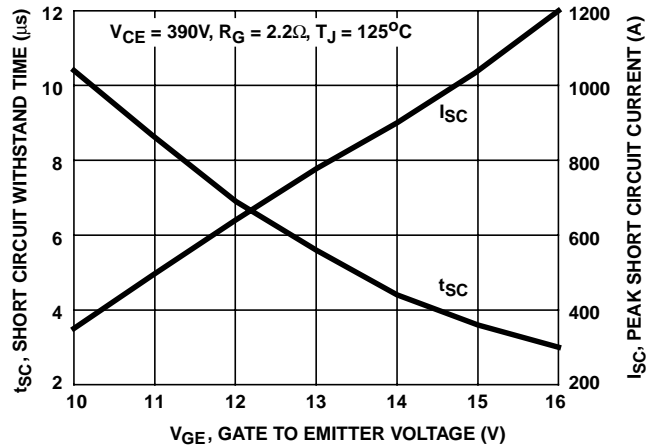

FIGURE 4. SHORT CIRCUIT WITHSTAND TIME

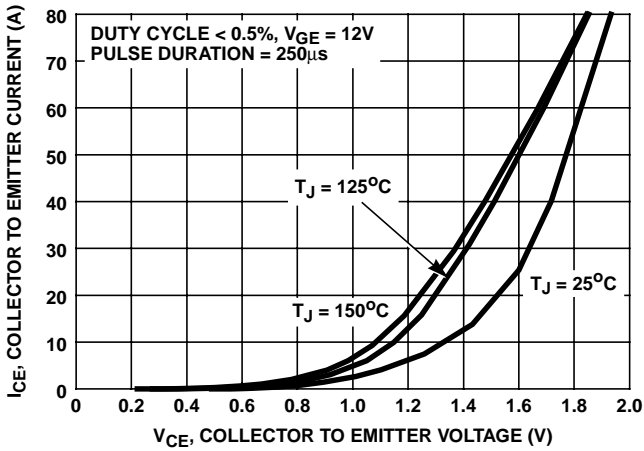

FIGURE 5. COLLECTOR TO EMITTER ON-STATE VOLTAGE

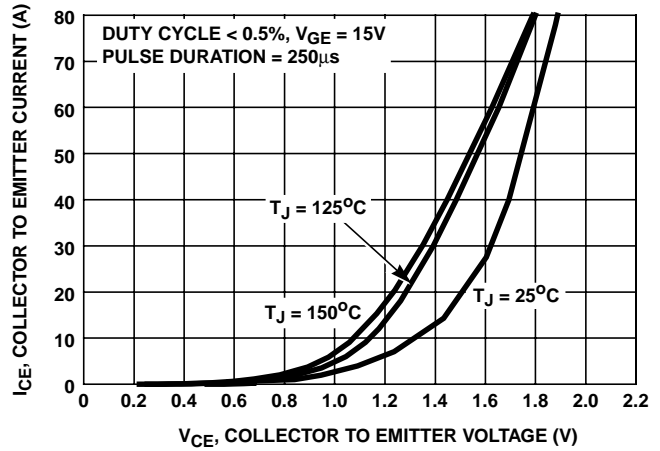

FIGURE 6. COLLECTOR TO EMITTER ON-STATE VOLTAGE

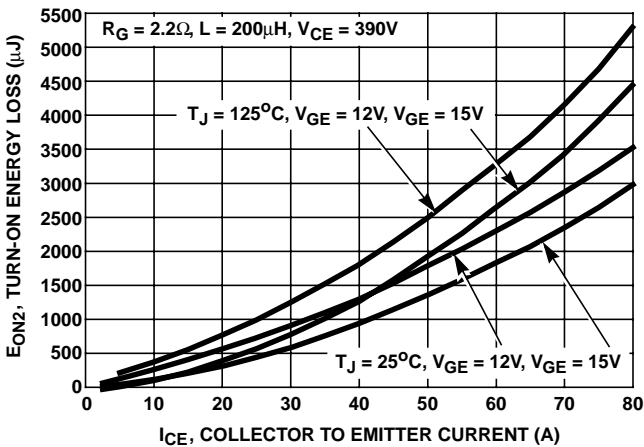

FIGURE 7. TURN-ON ENERGY LOSS vs COLLECTOR TO EMITTER CURRENT

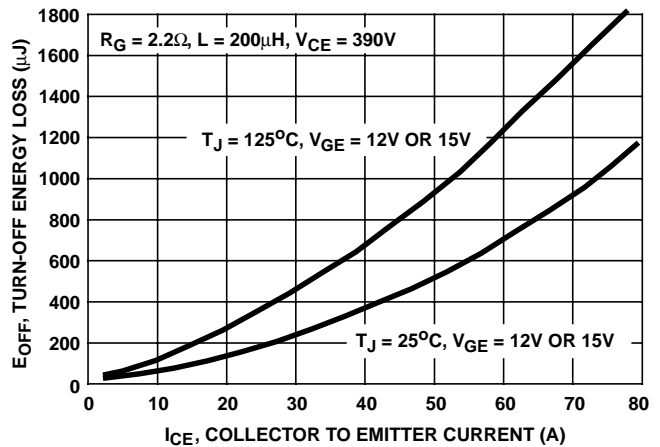

FIGURE 8. TURN-OFF ENERGY LOSS vs COLLECTOR TO EMITTER CURRENT

Typical Performance Curves Unless Otherwise Specified (Continued)

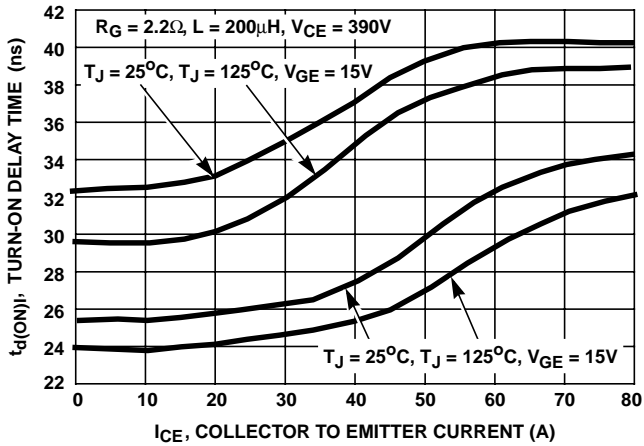

FIGURE 9. TURN-ON DELAY TIME vs COLLECTOR TO EMITTER CURRENT

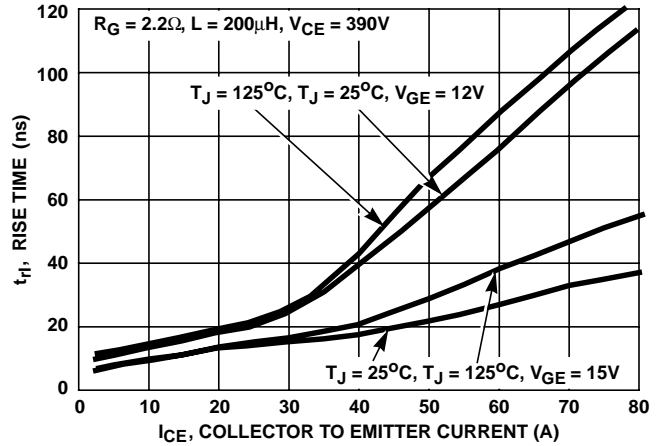

FIGURE 10. TURN-ON RISE TIME vs COLLECTOR TO EMITTER CURRENT

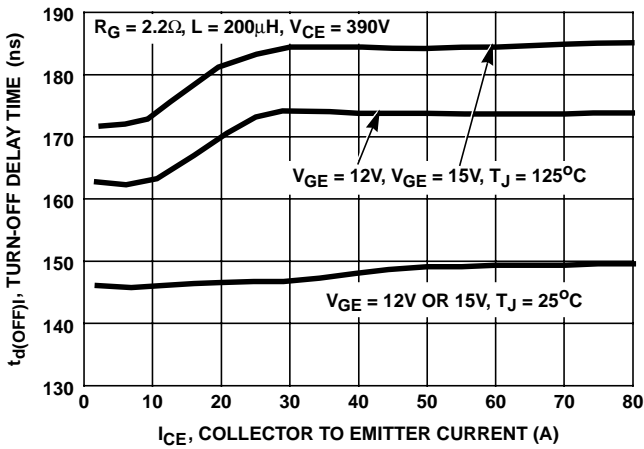

FIGURE 11. TURN-OFF DELAY TIME vs COLLECTOR TO EMITTER CURRENT

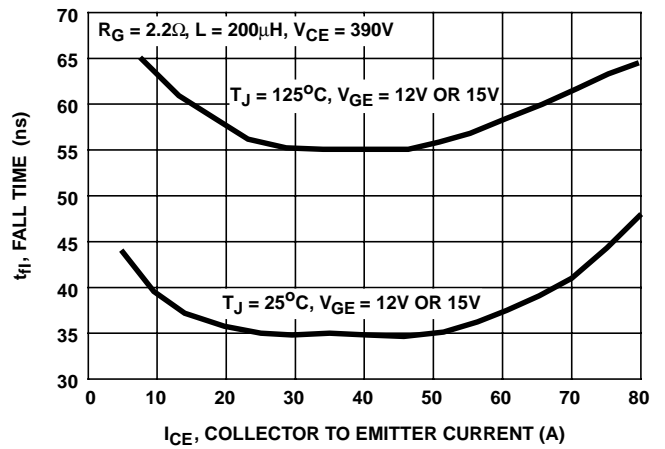

FIGURE 12. FALL TIME vs COLLECTOR TO EMITTER CURRENT

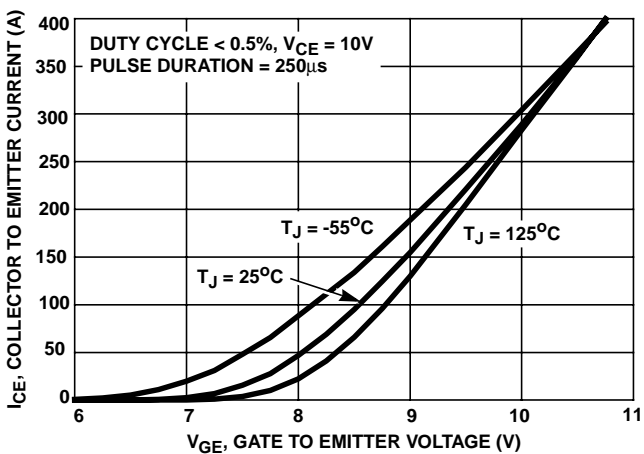

FIGURE 13. TRANSFER CHARACTERISTIC

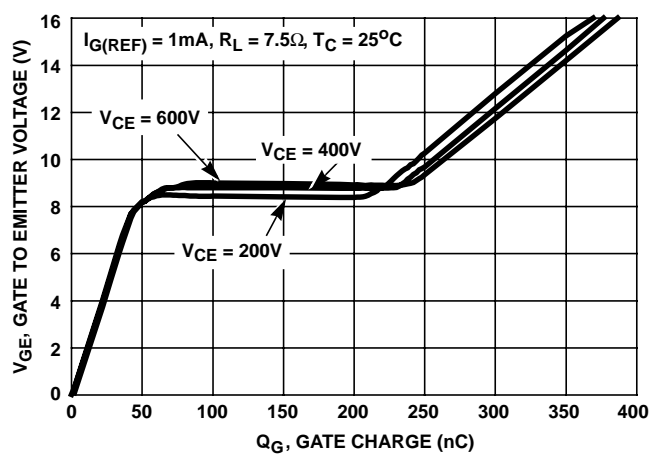

FIGURE 14. GATE CHARGE WAVEFORMS

Typical Performance Curves Unless Otherwise Specified (Continued)

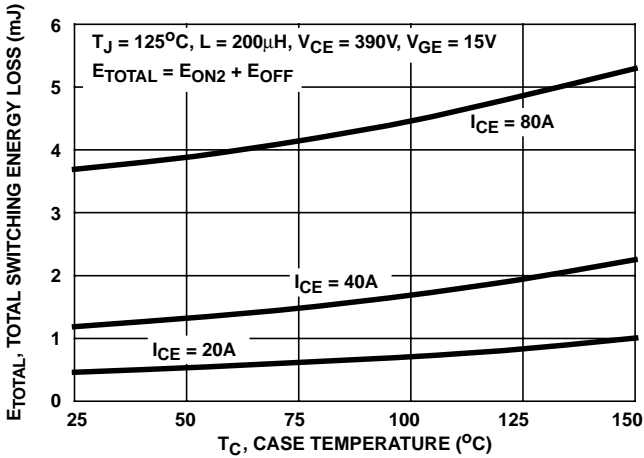

FIGURE 15. TOTAL SWITCHING LOSS vs CASE TEMPERATURE

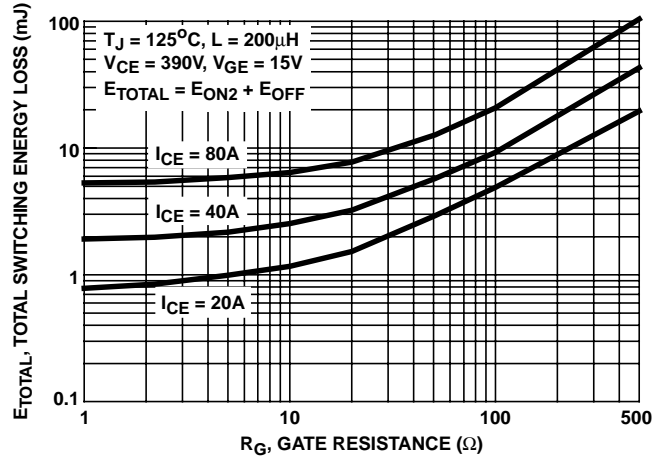

FIGURE 16. TOTAL SWITCHING LOSS vs GATE RESISTANCE

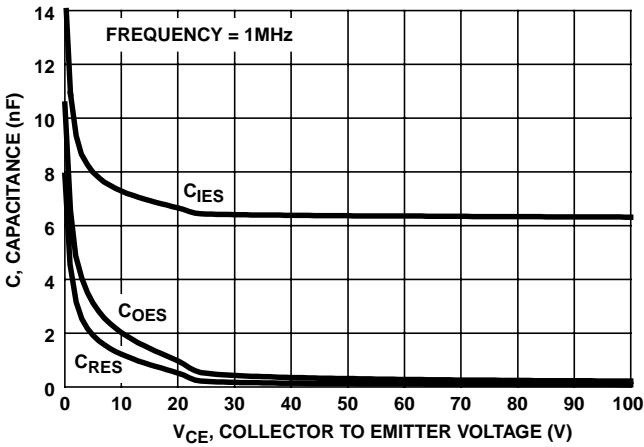

FIGURE 17. CAPACITANCE vs COLLECTOR TO EMITTER VOLTAGE

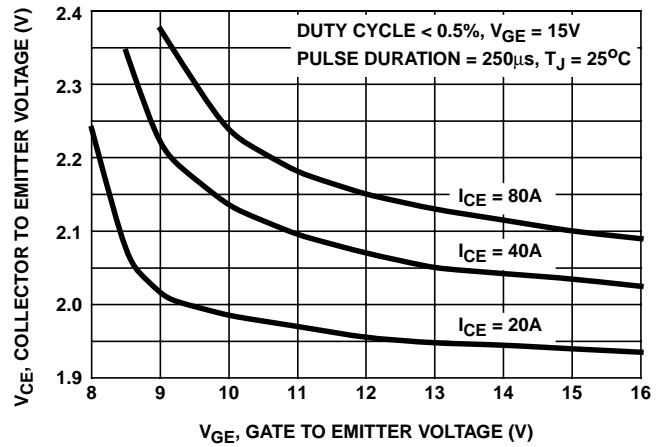

FIGURE 18. COLLECTOR TO EMITTER ON-STATE VOLTAGE vs GATE TO EMITTER VOLTAGE

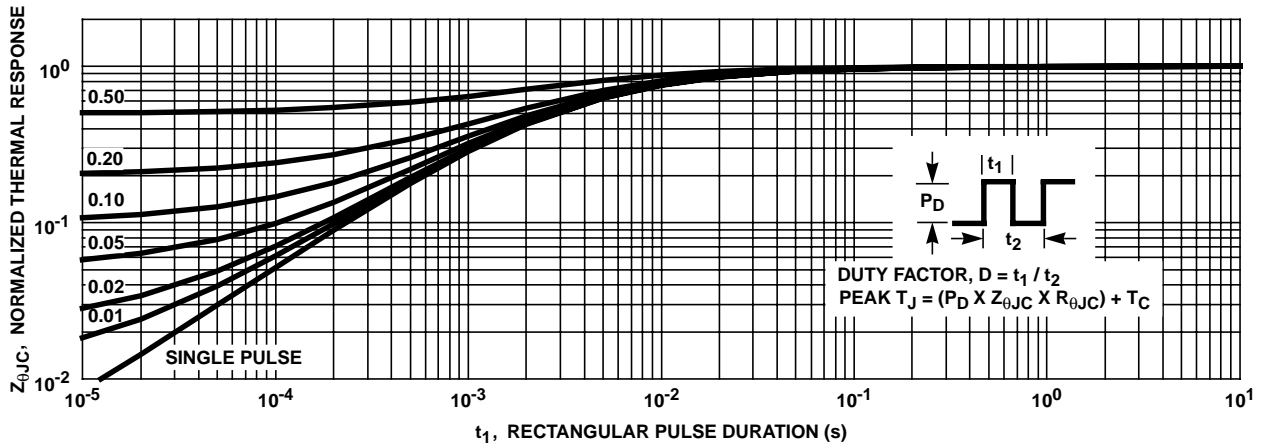

FIGURE 19. NORMALIZED TRANSIENT THERMAL RESPONSE, JUNCTION TO CASE

## Test Circuit and Waveforms

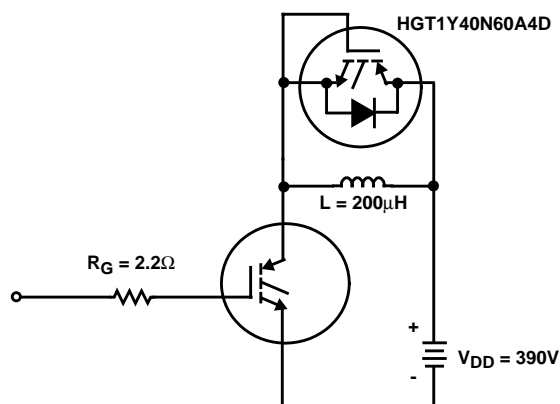

FIGURE 20. INDUCTIVE SWITCHING TEST CIRCUIT

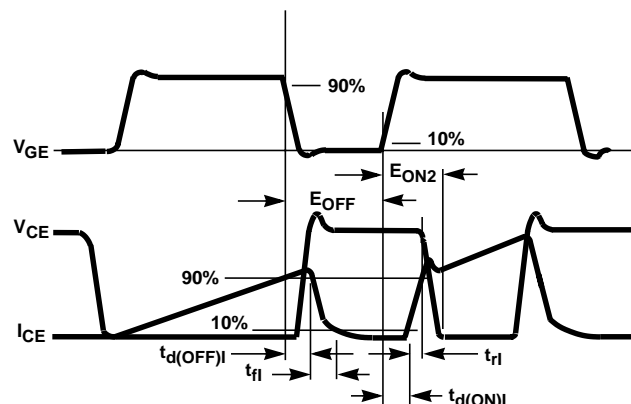

FIGURE 21. SWITCHING TEST WAVEFORMS

### Handling Precautions for IGBTs

Insulated Gate Bipolar Transistors are susceptible to gate-insulation damage by the electrostatic discharge of energy through the devices. When handling these devices, care should be exercised to assure that the static charge built in the handler's body capacitance is not discharged through the device. With proper handling and application procedures, however, IGBTs are currently being extensively used in production by numerous equipment manufacturers in military, industrial and consumer applications, with virtually no damage problems due to electrostatic discharge. IGBTs can be handled safely if the following basic precautions are taken:

1. Prior to assembly into a circuit, all leads should be kept shorted together either by the use of metal shorting springs or by the insertion into conductive material such as "ECCOSORBD™ LD26" or equivalent.
2. When devices are removed by hand from their carriers, the hand being used should be grounded by any suitable means - for example, with a metallic wristband.
3. Tips of soldering irons should be grounded.
4. Devices should never be inserted into or removed from circuits with power on.
5. **Gate Voltage Rating** - Never exceed the gate-voltage rating of  $V_{GEM}$ . Exceeding the rated  $V_{GE}$  can result in permanent damage to the oxide layer in the gate region.
6. **Gate Termination** - The gates of these devices are essentially capacitors. Circuits that leave the gate open-circuited or floating should be avoided. These conditions can result in turn-on of the device due to voltage buildup on the input capacitor due to leakage currents or pickup.
7. **Gate Protection** - These devices do not have an internal monolithic Zener diode from gate to emitter. If gate protection is required an external Zener is recommended.

### Operating Frequency Information

Operating frequency information for a typical device (Figure 3) is presented as a guide for estimating device performance for a specific application. Other typical frequency vs collector current ( $I_{CE}$ ) plots are possible using the information shown for a typical unit in Figures 6, 7, 8, 9 and 11. The operating frequency plot (Figure 3) of a typical device shows  $f_{MAX1}$  or  $f_{MAX2}$ ; whichever is smaller at each point. The information is based on measurements of a typical device and is bounded by the maximum rated junction temperature.

$f_{MAX1}$  is defined by  $f_{MAX1} = 0.05 / (t_{d(OFF)I} + t_{d(ON)I})$ . Deadtime (the denominator) has been arbitrarily held to 10% of the on-state time for a 50% duty factor. Other definitions are possible.  $t_{d(OFF)I}$  and  $t_{d(ON)I}$  are defined in Figure 21. Device turn-off delay can establish an additional frequency limiting condition for an application other than  $T_{JM}$ .  $t_{d(OFF)I}$  is important when controlling output ripple under a lightly loaded condition.

$f_{MAX2}$  is defined by  $f_{MAX2} = (P_D - P_C) / (E_{OFF} + E_{ON2})$ . The allowable dissipation ( $P_D$ ) is defined by  $P_D = (T_{JM} - T_C) / R_{\theta JC}$ . The sum of device switching and conduction losses must not exceed  $P_D$ . A 50% duty factor was used (Figure 3) and the conduction losses ( $P_C$ ) are approximated by  $P_C = (V_{CE} \times I_{CE}) / 2$ .

$E_{ON2}$  and  $E_{OFF}$  are defined in the switching waveforms shown in Figure 21.  $E_{ON2}$  is the integral of the instantaneous power loss ( $I_{CE} \times V_{CE}$ ) during turn-on and  $E_{OFF}$  is the integral of the instantaneous power loss ( $I_{CE} \times V_{CE}$ ) during turn-off. All tail losses are included in the calculation for  $E_{OFF}$ ; i.e., the collector current equals zero ( $I_{CE} = 0$ ).

**TO-247**

**3 LEAD JEDEC STYLE TO-247 PLASTIC PACKAGE**

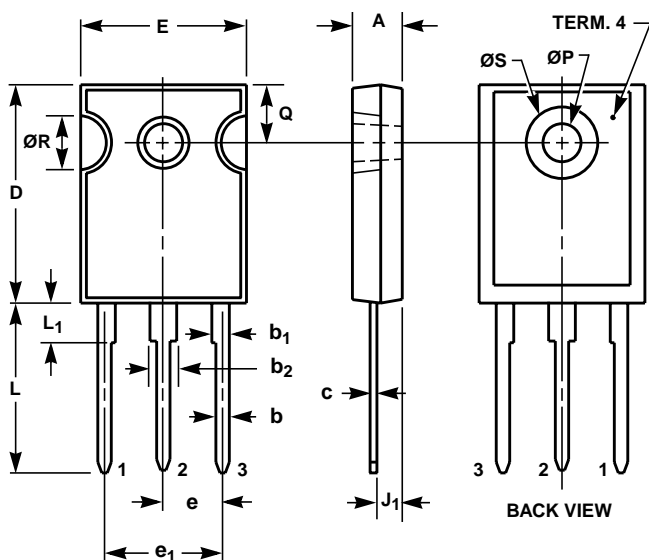

| SYMBOL         | INCHES    |       | MILLIMETERS |       | NOTES   |
|----------------|-----------|-------|-------------|-------|---------|
|                | MIN       | MAX   | MIN         | MAX   |         |
| A              | 0.180     | 0.190 | 4.58        | 4.82  | -       |
| b              | 0.046     | 0.051 | 1.17        | 1.29  | 2, 3    |
| b <sub>1</sub> | 0.060     | 0.070 | 1.53        | 1.77  | 1, 2    |
| b <sub>2</sub> | 0.095     | 0.105 | 2.42        | 2.66  | 1, 2    |
| c              | 0.020     | 0.026 | 0.51        | 0.66  | 1, 2, 3 |
| D              | 0.800     | 0.820 | 20.32       | 20.82 | -       |
| E              | 0.605     | 0.625 | 15.37       | 15.87 | -       |
| e              | 0.219 TYP |       | 5.56 TYP    |       | 4       |
| e <sub>1</sub> | 0.438 BSC |       | 11.12 BSC   |       | 4       |
| J <sub>1</sub> | 0.090     | 0.105 | 2.29        | 2.66  | 5       |
| L              | 0.620     | 0.640 | 15.75       | 16.25 | -       |
| L <sub>1</sub> | 0.145     | 0.155 | 3.69        | 3.93  | 1       |
| ØP             | 0.138     | 0.144 | 3.51        | 3.65  | -       |
| Q              | 0.210     | 0.220 | 5.34        | 5.58  | -       |
| ØR             | 0.195     | 0.205 | 4.96        | 5.20  | -       |
| ØS             | 0.260     | 0.270 | 6.61        | 6.85  | -       |

**NOTES:**

1. Lead dimension and finish uncontrolled in L<sub>1</sub>.
2. Lead dimension (without solder).
3. Add typically 0.002 inches (0.05mm) for solder coating.
4. Position of lead to be measured 0.250 inches (6.35mm) from bottom of dimension D.
5. Position of lead to be measured 0.100 inches (2.54mm) from bottom of dimension D.
6. Controlling dimension: Inch.
7. Revision 1 dated 1-93.

All Intersil semiconductor products are manufactured, assembled and tested under **ISO9000** quality systems certification.

*Intersil semiconductor products are sold by description only. Intersil Corporation reserves the right to make changes in circuit design and/or specifications at any time without notice. Accordingly, the reader is cautioned to verify that data sheets are current before placing orders. Information furnished by Intersil is believed to be accurate and reliable. However, no responsibility is assumed by Intersil or its subsidiaries for its use; nor for any infringements of patents or other rights of third parties which may result from its use. No license is granted by implication or otherwise under any patent or patent rights of Intersil or its subsidiaries.*

For information regarding Intersil Corporation and its products, see web site [www.intersil.com](http://www.intersil.com)

**Sales Office Headquarters**

**NORTH AMERICA**

Intersil Corporation  
 P. O. Box 883, Mail Stop 53-204  
 Melbourne, FL 32902  
 TEL: (321) 724-7000  
 FAX: (321) 724-7240

**EUROPE**

Intersil SA  
 Mercure Center  
 100, Rue de la Fusee  
 1130 Brussels, Belgium  
 TEL: (32) 2.724.2111  
 FAX: (32) 2.724.22.05

**ASIA**

Intersil (Taiwan) Ltd.  
 7F-6, No. 101 Fu Hsing North Road  
 Taipei, Taiwan  
 Republic of China  
 TEL: (886) 2 2716 9310  
 FAX: (886) 2 2715 3029