

HI5746

10-Bit, 40MSPS A/D Converter

**NOT RECOMMENDED FOR NEW DESIGNS  
NO RECOMMENDED REPLACEMENT**  
contact our Technical Support Center at  
1-888-INTERSIL or www.intersil.com/tsc

FN4129  
Rev 5.00  
July 2004

The HI5746 is a monolithic, 10-bit, analog-to-digital converter fabricated in a CMOS process. It is designed for high speed applications where wide bandwidth and low power consumption are essential. Its 40MSPS speed is made possible by a fully differential pipelined architecture with an internal sample and hold.

The HI5746 has excellent dynamic performance while consuming only 225mW power at 40MSPS. Data output latches are provided which present valid data to the output bus with a latency of 7 clock cycles. It is pin-for-pin functionally compatible with the HI5702 and the HI5703.

For internal voltage reference, please refer to the HI5767 data sheet.

**Ordering Information**

PART NUMBER	TEMP. RANGE (°C)	PACKAGE	PKG. DWG. #
HI5746KCB	0 to 70	28 Ld SOIC (W)	M28.3
HI5746KCBZ (Note)	0 to 70	28 Ld SOIC (W) (Pb-free)	M28.3
HI5746KCBZ-T (Note)	28 Ld SOIC (W) Tape and Reel (Pb-free)		M28.3
HI5746KCA	0 to 70	28 Ld SSOP	M28.15
HI5746KCAZ (Note)	0 to 70	28 Ld SSOP (Pb-free)	M28.15
HI5746EVAL1	25	Evaluation Board	

NOTE: Intersil Pb-free products employ special Pb-free material sets; molding compounds/die attach materials and 100% matte tin plate termination finish, which is compatible with both SnPb and Pb-free soldering operations. Intersil Pb-free products are MSL classified at Pb-free peak reflow temperatures that meet or exceed the Pb-free requirements of IPC/JEDEC J Std-020B.

**Features**

- Sampling Rate . . . . . 40MSPS
- 8.8 Bits at  $f_{IN} = 10\text{MHz}$
- Low Power at 40MSPS . . . . . 225mW
- Wide Full Power Input Bandwidth . . . . . 250MHz
- On-Chip Sample and Hold
- Fully Differential or Single-Ended Analog Input
- Single Supply Voltage . . . . . +5V
- TTL/CMOS Compatible Digital Inputs
- CMOS Compatible Digital Outputs . . . . . 3.0/5.0V
- Offset Binary or Two's Complement Output Format
- Pb-free Available

**Applications**

- Professional Video Digitizing
- Medical Imaging
- Digital Communication Systems
- High Speed Data Acquisition

**Pinout**

HI5746  
(SOIC, SSOP)  
TOP VIEW

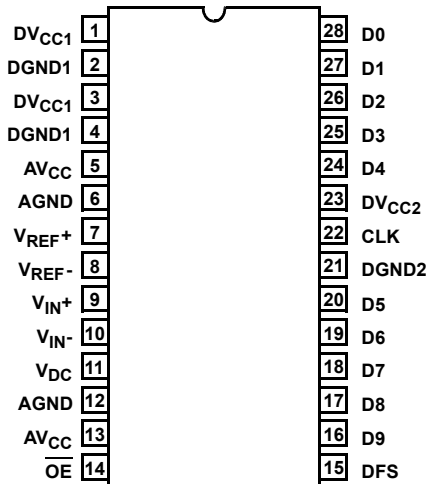

**Functional Block Diagram**

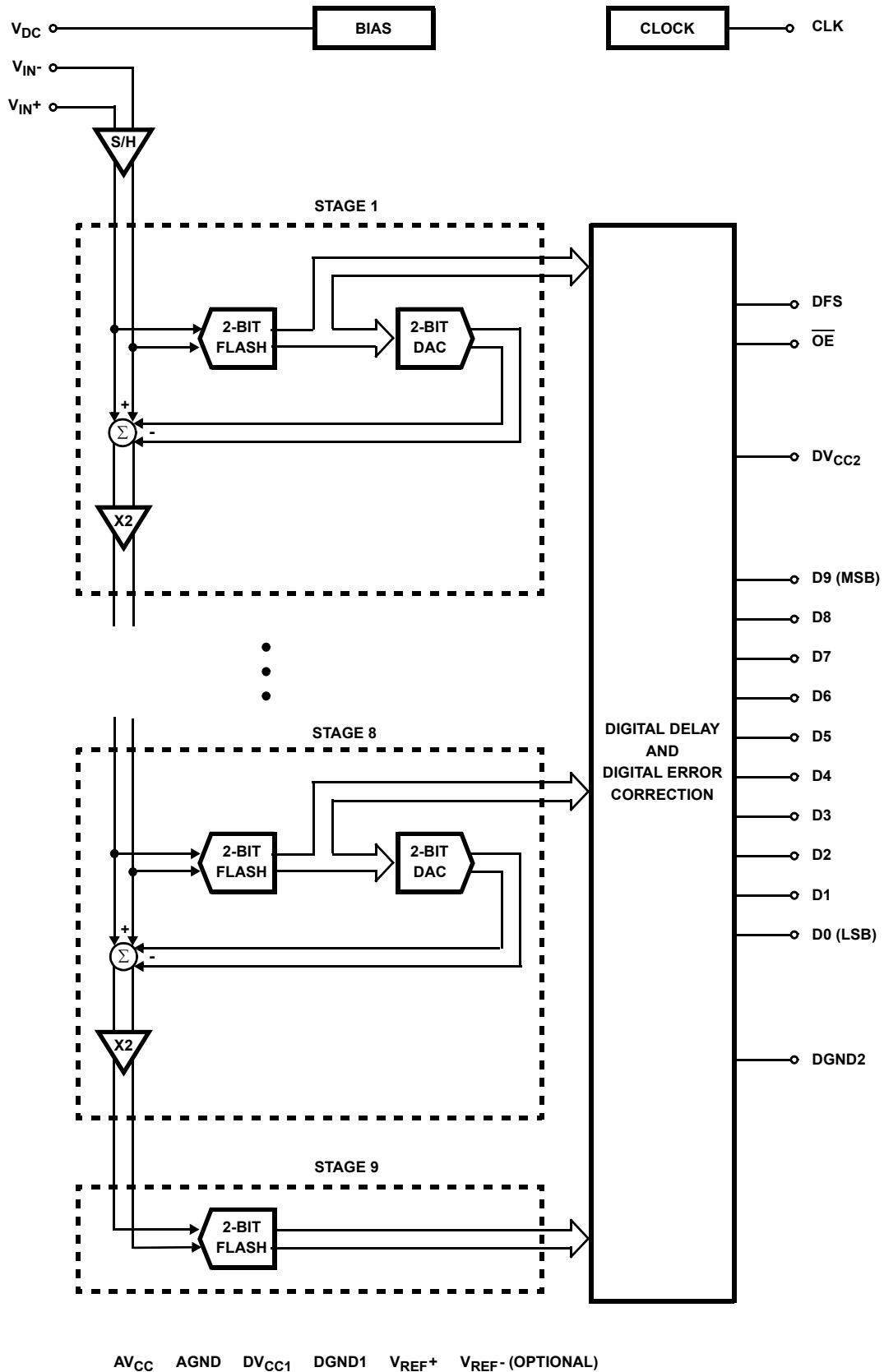

**Typical Application Schematic**

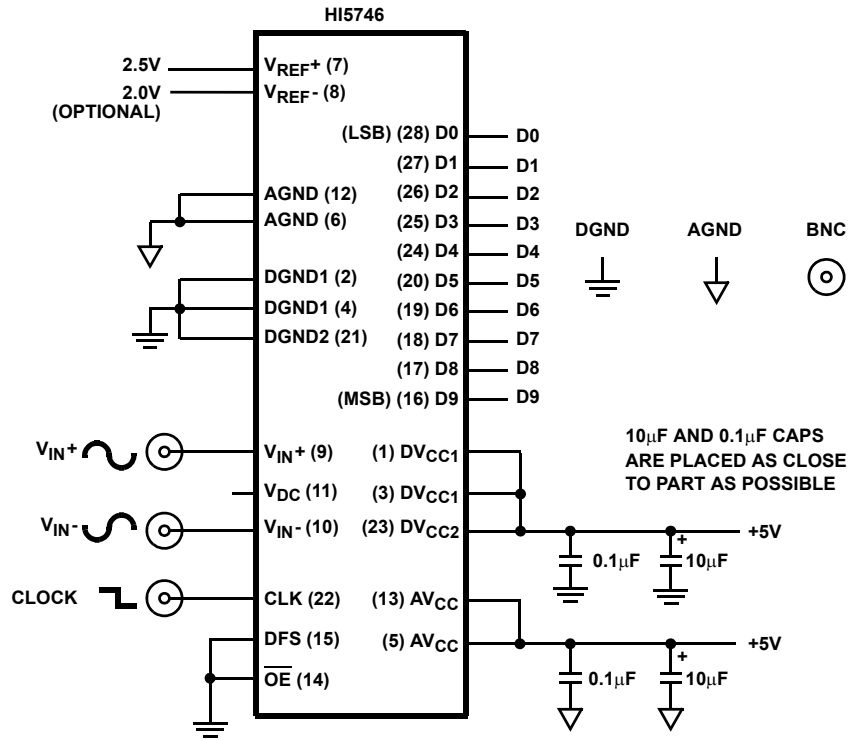

**Pin Descriptions**

PIN NO.	NAME	DESCRIPTION
1	DV <sub>CC1</sub>	Digital Supply (+5.0V).
2	DGND1	Digital Ground.
3	DV <sub>CC1</sub>	Digital Supply (+5.0V).
4	DGND1	Digital Ground.
5	AV <sub>CC</sub>	Analog Supply (+5.0V).
6	AGND	Analog Ground.
7	V <sub>REF+</sub>	+2.5V Positive Reference Voltage Input.
8	V <sub>REF-</sub>	+2.0V Negative Reference Voltage Input (Optional).
9	V <sub>IN+</sub>	Positive Analog Input.
10	V <sub>IN-</sub>	Negative Analog Input.
11	V <sub>DC</sub>	DC Bias Voltage Output.
12	AGND	Analog Ground.
13	AV <sub>CC</sub>	Analog Supply (+5.0V).
14	$\overline{OE}$	Digital Output Enable Control Input.
15	DFS	Data Format Select Input.

PIN NO.	NAME	DESCRIPTION
16	D9	Data Bit 9 Output (MSB).
17	D8	Data Bit 8 Output.
18	D7	Data Bit 7 Output.
19	D6	Data Bit 6 Output.
20	D5	Data Bit 5 Output.
21	DGND2	Digital Ground.
22	CLK	Sample Clock Input.
23	DV <sub>CC2</sub>	Digital Output Supply (+3.0V or +5.0V).
24	D4	Data Bit 4 Output.
25	D3	Data Bit 3 Output.
26	D2	Data Bit 2 Output.
27	D1	Data Bit 1 Output.
28	D0	Data Bit 0 Output (LSB).

**Absolute Maximum Ratings**  $T_A = 25^{\circ}\text{C}$

Supply Voltage,  $AV_{CC}$  or  $DV_{CC}$  to AGND or DGND ..... 6V  
 DGND to AGND ..... 0.3V  
 Digital I/O Pins ..... DGND to  $DV_{CC}$   
 Analog I/O Pins ..... AGND to  $AV_{CC}$

**Operating Conditions**

Temperature Range  
 HI5746KCB (Typ) .....  $0^{\circ}\text{C}$  to  $70^{\circ}\text{C}$

**Thermal Information**

Thermal Resistance (Typical, Note 1)  $\theta_{JA}$  ( $^{\circ}\text{C}/\text{W}$ )  
 SOIC Package ..... 70  
 SSOP Package ..... 100  
 Maximum Junction Temperature .....  $150^{\circ}\text{C}$   
 Maximum Storage Temperature Range .....  $-65^{\circ}\text{C}$  to  $150^{\circ}\text{C}$   
 Maximum Lead Temperature (Soldering 10s) .....  $300^{\circ}\text{C}$   
 (SOIC, SSOP - Lead Tips Only)

*CAUTION: Stresses above those listed in "Absolute Maximum Ratings" may cause permanent damage to the device. This is a stress only rating and operation of the device at these or any other conditions above those indicated in the operational sections of this specification is not implied.*

**NOTE:**

- $\theta_{JA}$  is measured with the component mounted on an evaluation PC board in free air.

**Electrical Specifications**  $AV_{CC} = DV_{CC1} = 5.0\text{V}$ ;  $DV_{CC2} = 3.0\text{V}$ ,  $V_{REF+} = 2.5\text{V}$ ;  $V_{REF-} = 2.0\text{V}$ ;  $f_S = 40$  MSPS at 50% Duty Cycle;  $C_L = 10\text{pF}$ ;  $T_A = 25^{\circ}\text{C}$ ; Differential Analog Input; Typical Values are Test Results at  $25^{\circ}\text{C}$ , Unless Otherwise Specified

PARAMETER	TEST CONDITIONS	MIN	TYP	MAX	UNITS
<b>ACCURACY</b>					
Resolution		10	-	-	Bits
Integral Linearity Error, INL	$f_{IN} = \text{DC}$	-	$\pm 1.0$	$\pm 2.0$	LSB
Differential Linearity Error, DNL (Guaranteed No Missing Codes)	$f_{IN} = \text{DC}$	-	$\pm 0.5$	$\pm 1.0$	LSB
Offset Error, $V_{OS}$	$f_{IN} = \text{DC}$	-40	12	40	LSB
Full Scale Error, FSE	$f_{IN} = \text{DC}$	-	4	-	LSB
<b>DYNAMIC CHARACTERISTICS</b>					
Minimum Conversion Rate	No Missing Codes	-	0.5	1	MSPS
Maximum Conversion Rate	No Missing Codes	40	-	-	MSPS
Effective Number of Bits, ENOB	$f_{IN} = 10\text{MHz}$	8.55	8.8	-	Bits
Signal to Noise and Distortion Ratio, SINAD = $\frac{\text{RMS Signal}}{\text{RMS Noise} + \text{Distortion}}$	$f_{IN} = 10\text{MHz}$	53.2	54.9	-	dB
Signal to Noise Ratio, SNR = $\frac{\text{RMS Signal}}{\text{RMS Noise}}$	$f_{IN} = 10\text{MHz}$	53.2	55.4	-	dB
Total Harmonic Distortion, THD	$f_{IN} = 10\text{MHz}$	-	-64.6	-	dBc
2nd Harmonic Distortion	$f_{IN} = 10\text{MHz}$	-	-67.8	-	dBc
3rd Harmonic Distortion	$f_{IN} = 10\text{MHz}$	-	-68.3	-	dBc
Spurious Free Dynamic Range, SFDR	$f_{IN} = 10\text{MHz}$	-	67.8	-	dBc
Intermodulation Distortion, IMD	$f_1 = 1\text{MHz}$ , $f_2 = 1.02\text{MHz}$	-	64	-	dBc
Differential Gain Error	$f_S = 17.72$ MSPS, 6 Step, Mod Ramp	-	0.8	-	%
Differential Phase Error	$f_S = 17.72$ MSPS, 6 Step, Mod Ramp	-	0.1	-	Degree
Transient Response	(Note 2)	-	1	-	Cycle
Over-Voltage Recovery	0.2V Overdrive (Note 2)	-	1	-	Cycle

**Electrical Specifications**  $AV_{CC} = DV_{CC1} = 5.0V$ ;  $DV_{CC2} = 3.0V$ ;  $V_{REF+} = 2.5V$ ;  $V_{REF-} = 2.0V$ ;  $f_S = 40$  MSPS at 50% Duty Cycle;  $C_L = 10pF$ ;  $T_A = 25^{\circ}C$ ; Differential Analog Input; Typical Values are Test Results at  $25^{\circ}C$ , Unless Otherwise Specified **(Continued)**

PARAMETER	TEST CONDITIONS	MIN	TYP	MAX	UNITS
<b>ANALOG INPUT</b>					
Maximum Peak-to-Peak Differential Analog Input Range ( $V_{IN+} - V_{IN-}$ )		-	$\pm 0.5$	-	V
Maximum Peak-to-Peak Single-Ended Analog Input Range		-	1.0	-	V
Analog Input Resistance, $R_{IN}$	(Note 3)	-	1	-	$M\Omega$
Analog Input Capacitance, $C_{IN}$		-	10	-	pF
Analog Input Bias Current, $I_{B+}$ or $I_{B-}$	(Note 3)	-10	-	+10	$\mu A$
Differential Analog Input Bias Current $I_{BDIFF} = (I_{B+} - I_{B-})$	(Note 3)	-	$\pm 0.5$	-	$\mu A$
Full Power Input Bandwidth, FPBW		-	250	-	MHz
Analog Input Common Mode Voltage Range ( $V_{IN+} + V_{IN-}$ )/2	Differential Mode (Note 2)	0.25	-	4.75	V
<b>REFERENCE INPUT</b>					
Total Reference Resistance, $R_L$	$V_{REF+}$ to AGND	-	2.5K	-	$\Omega$
Positive Reference Current, $I_{REF+}$		-	1.07	-	mA
Negative Reference Current, $I_{REF-}$		-	21	-	$\mu A$
Positive Reference Voltage Input, $V_{REF+}$	(Note 2)	-	2.5	-	V
Negative Reference Voltage Input, $V_{REF-}$	(Note 2)	-	2.0	-	V
Reference Common Mode Voltage ( $V_{REF+} + V_{REF-}$ )/2	(Note 2)	-	2.25	-	V
<b>DC BIAS VOLTAGE</b>					
DC Bias Voltage Output, $V_{DC}$		-	3.2	-	V
Maximum Output Current		-	-	0.4	mA
<b>DIGITAL INPUTS</b>					
Input Logic High Voltage, $V_{IH}$	CLK, DFS, $\overline{OE}$	2.0	-	-	V
Input Logic Low Voltage, $V_{IL}$	CLK, DFS, $\overline{OE}$	-	-	0.8	V
Input Logic High Current, $I_{IH}$	CLK, DFS, $\overline{OE}$ , $V_{IH} = 5V$	-10.0	-	+10.0	$\mu A$
Input Logic Low Current, $I_{IL}$	CLK, DFS, $\overline{OE}$ , $V_{IL} = 0V$	-10.0	-	+10.0	$\mu A$
Input Capacitance, $C_{IN}$		-	7	-	pF
<b>DIGITAL OUTPUTS</b>					
Output Logic High Voltage, $V_{OH}$	$I_{OH} = 100\mu A$ ; $DV_{CC2} = 5V$	4.0	-	-	V
Output Logic Low Voltage, $V_{OL}$	$I_{OL} = 100\mu A$ ; $DV_{CC2} = 5V$	-	-	0.5	V
Output Three-State Leakage Current, $I_{OZ}$	$V_O = 0/5V$ ; $DV_{CC2} = 5V$	-	$\pm 1$	$\pm 10$	$\mu A$
Output Logic High Voltage, $V_{OH}$	$I_{OH} = 100\mu A$ ; $DV_{CC2} = 3V$	2.4	-	-	V
Output Logic Low Voltage, $V_{OL}$	$I_{OL} = 100\mu A$ ; $DV_{CC2} = 3V$	-	-	0.5	V

**Electrical Specifications**  $V_{CC} = DV_{CC1} = 5.0V$ ;  $DV_{CC2} = 3.0V$ ,  $V_{REF+} = 2.5V$ ;  $V_{REF-} = 2.0V$ ;  $f_S = 40$  MSPS at 50% Duty Cycle;  $C_L = 10pF$ ;  $T_A = 25^\circ C$ ; Differential Analog Input; Typical Values are Test Results at  $25^\circ C$ , Unless Otherwise Specified **(Continued)**

PARAMETER	TEST CONDITIONS	MIN	TYP	MAX	UNITS
Output Three-State Leakage Current, $I_{OZ}$	$V_O = 0/5V$ ; $DV_{CC2} = 3V$	-	$\pm 1$	$\pm 10$	$\mu A$
Output Capacitance, $C_{OUT}$		-	10	-	pF
<b>TIMING CHARACTERISTICS</b>					
Aperture Delay, $t_{AP}$		-	5	-	ns
Aperture Jitter, $t_{AJ}$		-	5	-	ps <sub>RMS</sub>
Data Output Hold, $t_H$		-	7	-	ns
Data Output Delay, $t_{OD}$		-	8	-	ns
Data Output Enable Time, $t_{EN}$		-	5	-	ns
Data Output Enable Time $t_{DIS}$		-	5	-	ns
Data Latency, $t_{LAT}$	For a Valid Sample (Note 2)	-	-	7	Cycles
Power-Up Initialization	Data Invalid Time (Note 2)	-	-	20	Cycles
<b>POWER SUPPLY CHARACTERISTICS</b>					
Analog Supply Voltage, $AV_{CC}$		4.75	5.0	5.25	V
Digital Supply Voltage $DV_{CC1}$		4.75	5.0	5.25	V
Digital Output Supply Voltage, $DV_{CC2}$	At 3.0V	2.7	3.0	3.3	V
	At 5.0V	4.75	5.0	5.25	V
Total Supply Current, $I_{CC}$	$f_{IN} = 10MHz$ and $DFS = "0"$	-	46	-	mA
Analog Supply Current, $AI_{CC}$	$f_{IN} = 10MHz$ and $DFS = "0"$	-	30	-	mA
Digital Supply Current, $DI_{CC1}$	$f_{IN} = 10MHz$ and $DFS = "0"$	-	13	-	mA
Output Supply Current, $DI_{CC2}$	$f_{IN} = 10MHz$ and $DFS = "0"$	-	3	-	mA
Power Dissipation	$f_{IN} = 10MHz$ and $DFS = "0"$	-	225	275	mW
Offset Error Sensitivity, $\Delta V_{OS}$	$AV_{CC}$ or $DV_{CC} = 5V \pm 5\%$	-	$\pm 0.4$	-	LSB
Gain Error Sensitivity, $\Delta FSE$	$AV_{CC}$ or $DV_{CC} = 5V \pm 5\%$	-	$\pm 0.8$	-	LSB

## NOTES:

- Parameter guaranteed by design or characterization and not production tested.
- With the clock low and DC input.

© Copyright Intersil Americas LLC 1999-2004. All Rights Reserved.  
All trademarks and registered trademarks are the property of their respective owners.

For additional products, see [www.intersil.com/en/products.html](http://www.intersil.com/en/products.html)

Intersil products are manufactured, assembled and tested utilizing ISO9001 quality systems as noted in the quality certifications found at [www.intersil.com/en/support/qualandreliability.html](http://www.intersil.com/en/support/qualandreliability.html)

*Intersil products are sold by description only. Intersil may modify the circuit design and/or specifications of products at any time without notice, provided that such modification does not, in Intersil's sole judgment, affect the form, fit or function of the product. Accordingly, the reader is cautioned to verify that datasheets are current before placing orders. Information furnished by Intersil is believed to be accurate and reliable. However, no responsibility is assumed by Intersil or its subsidiaries for its use; nor for any infringements of patents or other rights of third parties which may result from its use. No license is granted by implication or otherwise under any patent or patent rights of Intersil or its subsidiaries.*

For information regarding Intersil Corporation and its products, see [www.intersil.com](http://www.intersil.com)

Timing Waveforms

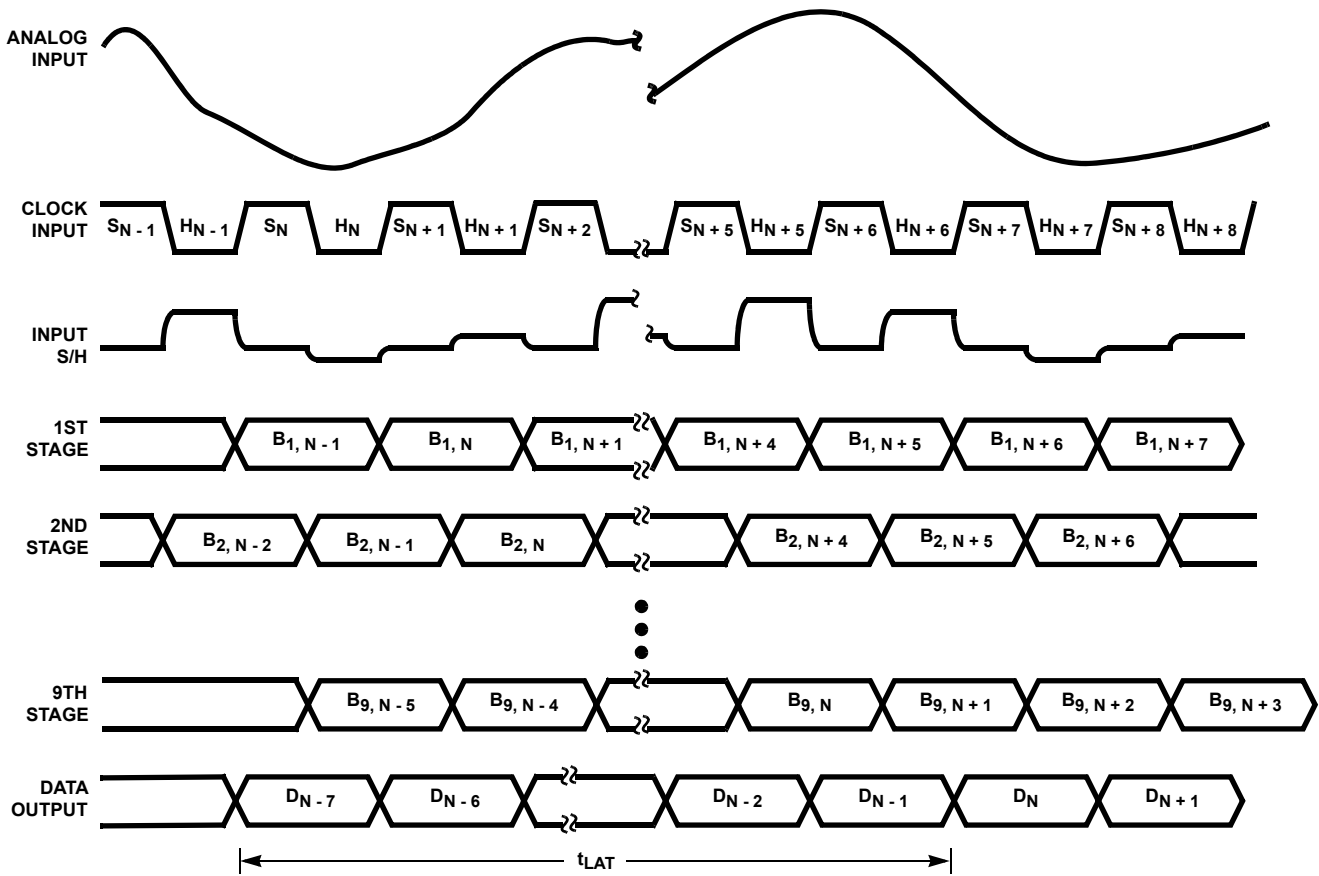

NOTES:

- 4.  $S_N$ : N-th sampling period.
- 5.  $H_N$ : N-th holding period.
- 6.  $B_{M,N}$ : M-th stage digital output corresponding to N-th sampled input.
- 7.  $D_N$ : Final data output corresponding to N-th sampled input.

FIGURE 1. HI5746 INTERNAL CIRCUIT TIMING

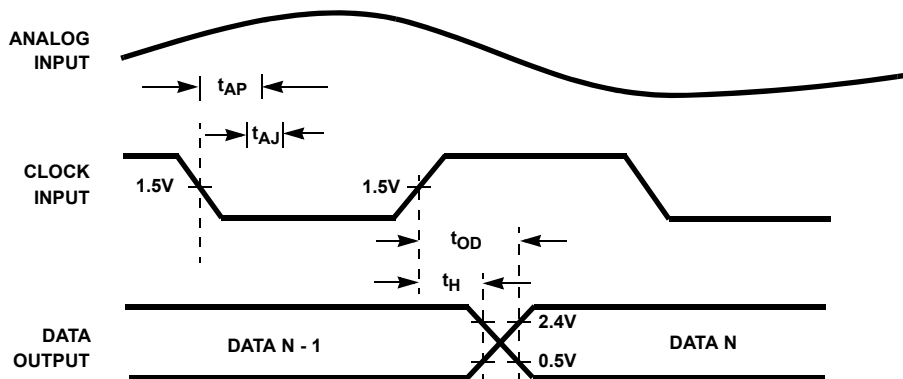

FIGURE 2. INPUT-TO OUTPUT TIMING

Typical Performance Curves

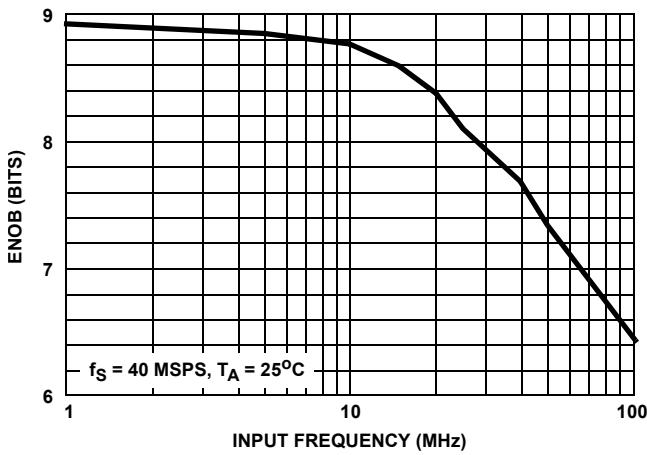

FIGURE 3. EFFECTIVE NUMBER OF BITS (ENOB) vs INPUT FREQUENCY

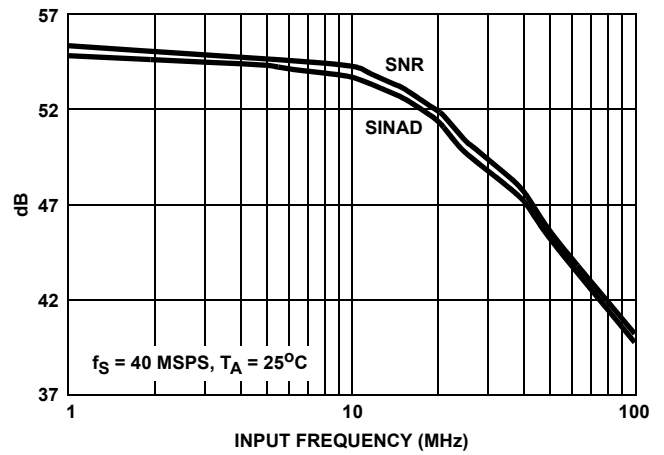
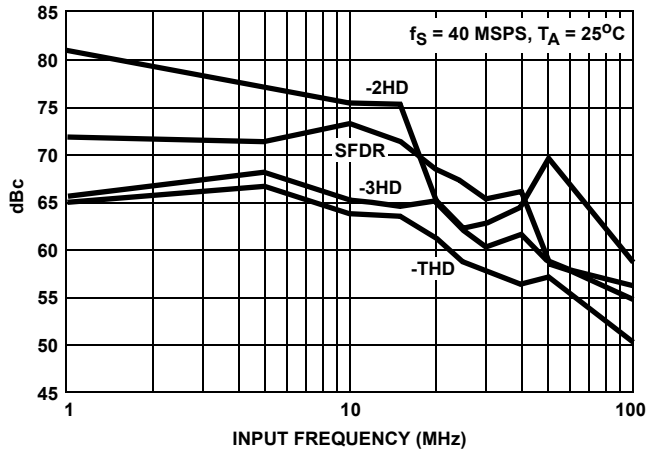

FIGURE 4. SINAD AND SNR vs INPUT FREQUENCY



NOTE: SFDR depicted here does not include any harmonic distortion.

FIGURE 5. -2HD, -3HD, -THD AND SFDR vs INPUT FREQUENCY

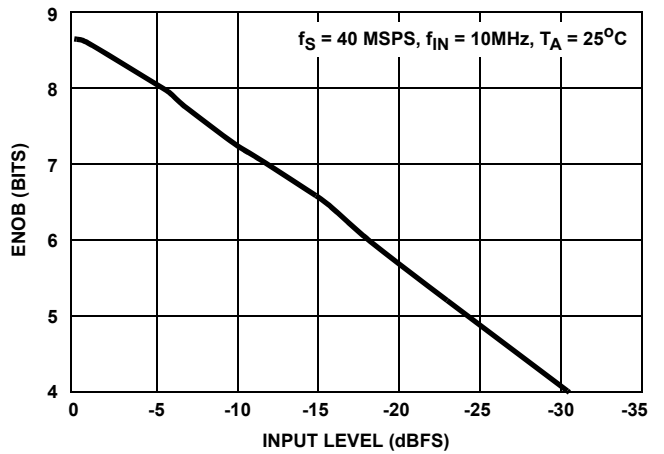

FIGURE 6. EFFECTIVE NUMBER OF BITS (ENOB) vs ANALOG INPUT LEVEL

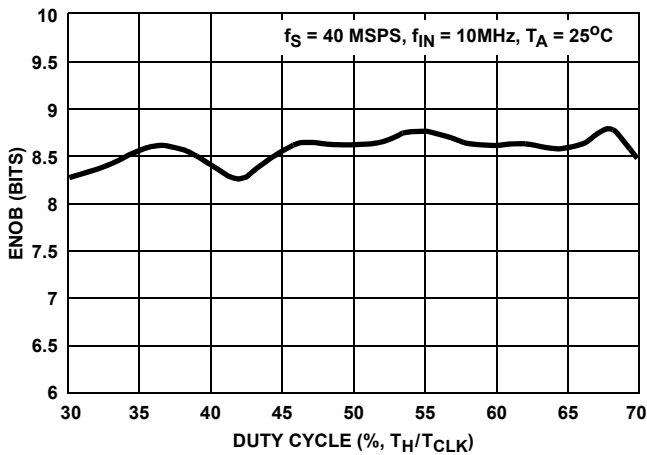

FIGURE 7. EFFECTIVE NUMBER OF BITS (ENOB) vs SAMPLE CLOCK DUTY CYCLE

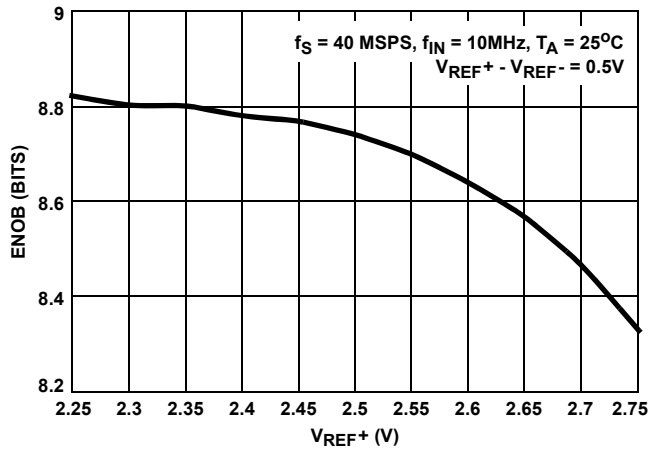

FIGURE 8. EFFECTIVE NUMBER OF BITS (ENOB) vs VREF+



Typical Performance Curves (Continued)

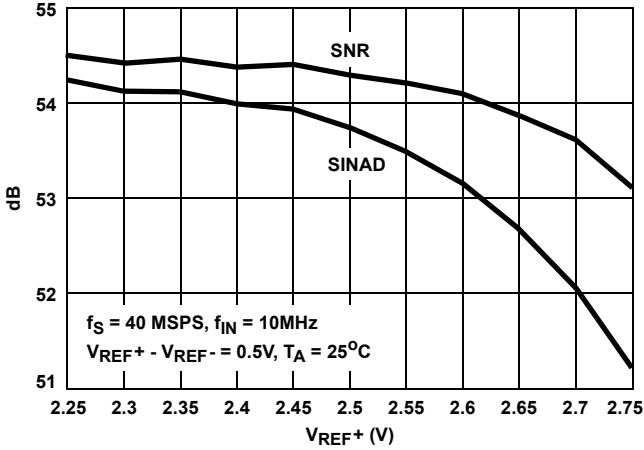
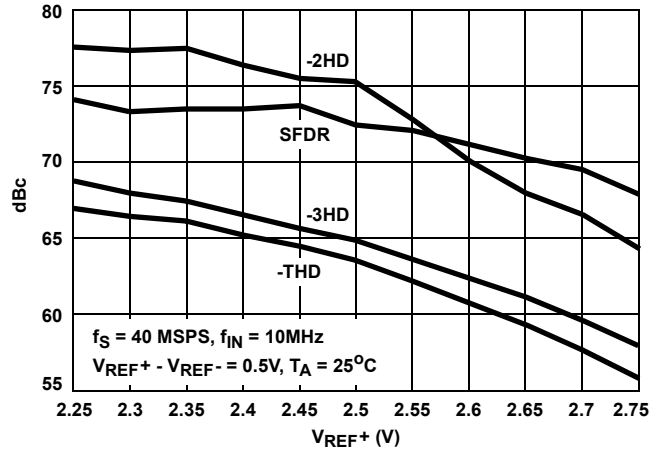

FIGURE 9. SINAD AND SNR vs  $V_{REF+}$



NOTE: SFDR depicted here does not include any harmonic distortion.

FIGURE 10. -2HD, -3HD, -THD AND SFDR vs  $V_{REF+}$

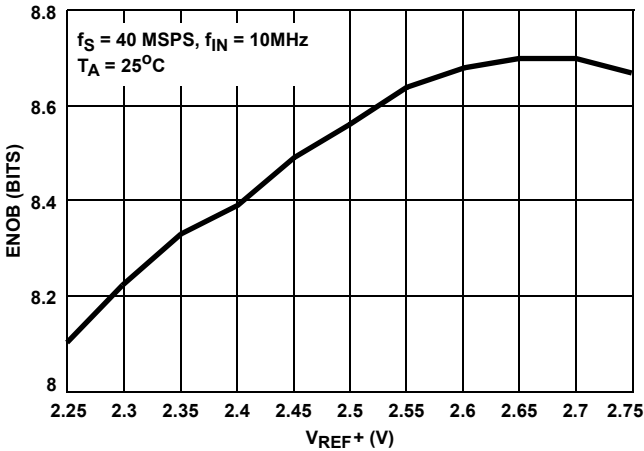

FIGURE 11. EFFECTIVE NUMBER OF BITS (ENOB) vs  $V_{REF+}$  ( $V_{REF-}$  NOT DRIVEN)

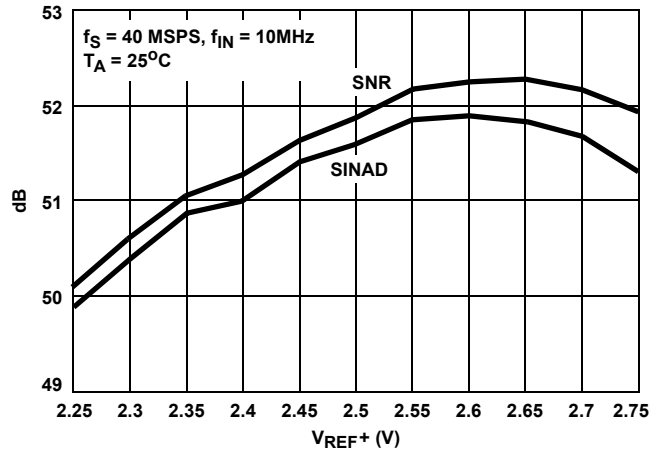

FIGURE 12. SINAD AND SNR vs  $V_{REF+}$  ( $V_{REF-}$  NOT DRIVEN)

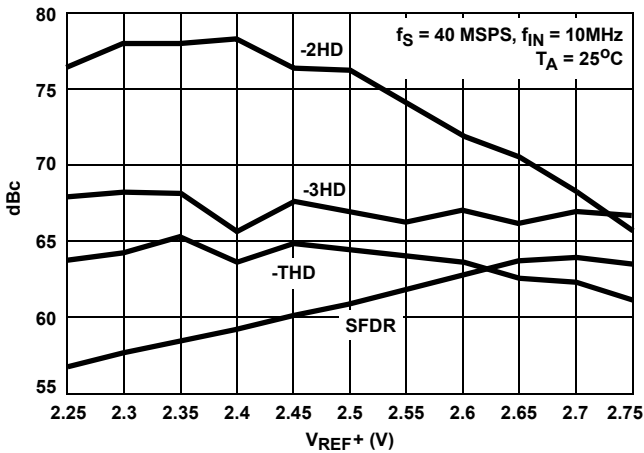

FIGURE 13. -2HD, -3HD, -THD AND SFDR vs  $V_{REF+}$  ( $V_{REF-}$  NOT DRIVEN)

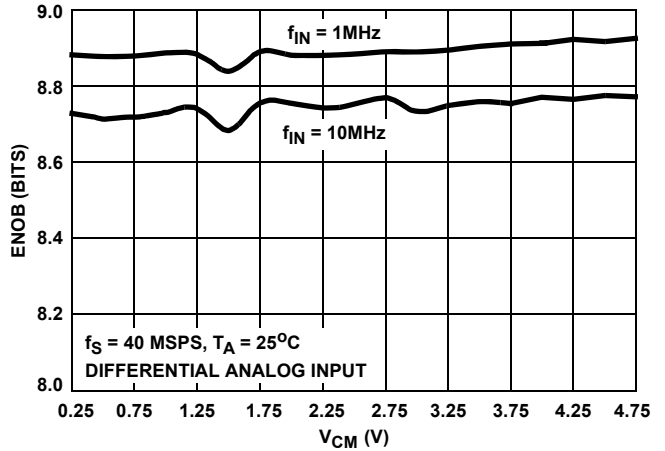

FIGURE 14. EFFECTIVE NUMBER OF BITS (ENOB) vs ANALOG INPUT COMMON MODE VOLTAGE

Typical Performance Curves (Continued)

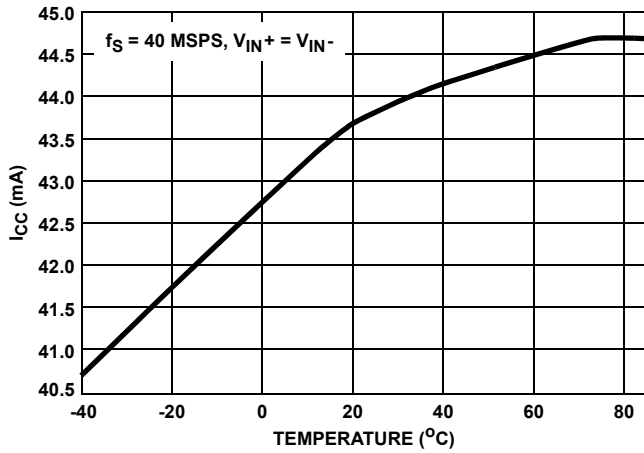

FIGURE 15. TOTAL SUPPLY CURRENT vs TEMPERATURE

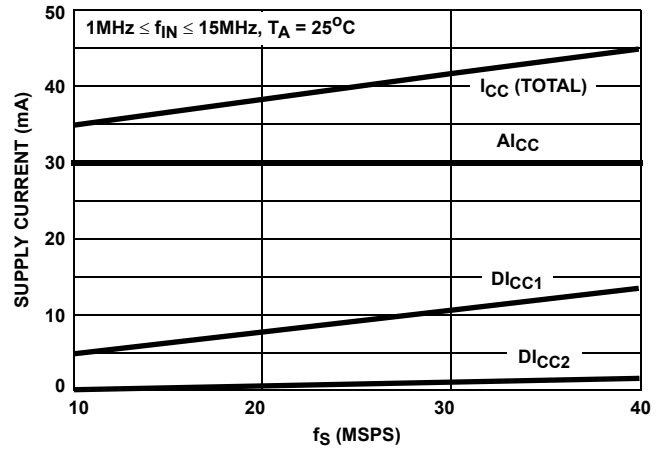

FIGURE 16. SUPPLY CURRENT vs SAMPLE CLOCK FREQUENCY

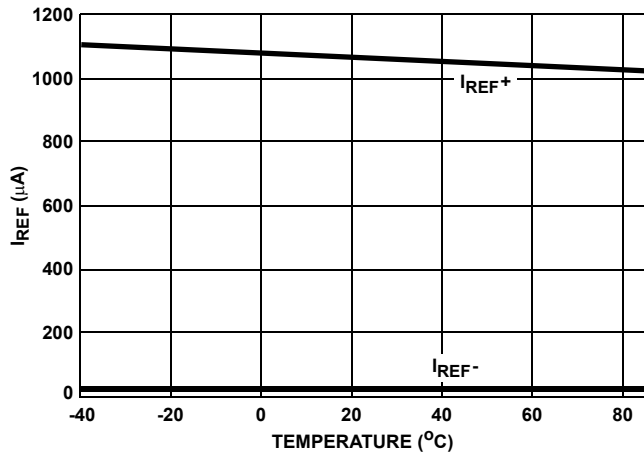

FIGURE 17. REFERENCE CURRENT vs TEMPERATURE

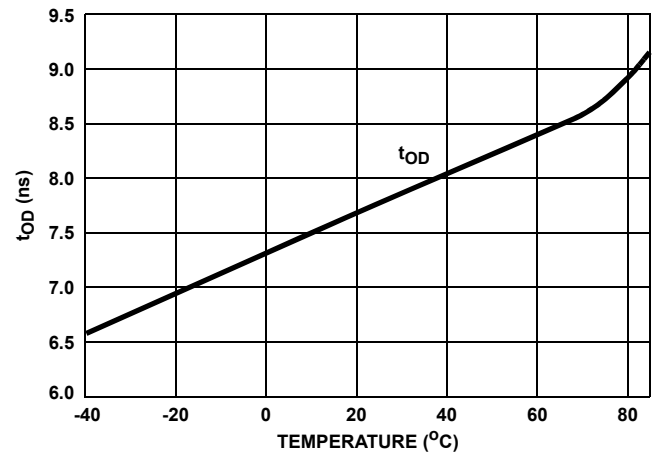

FIGURE 18. DATA OUTPUT DELAY vs TEMPERATURE

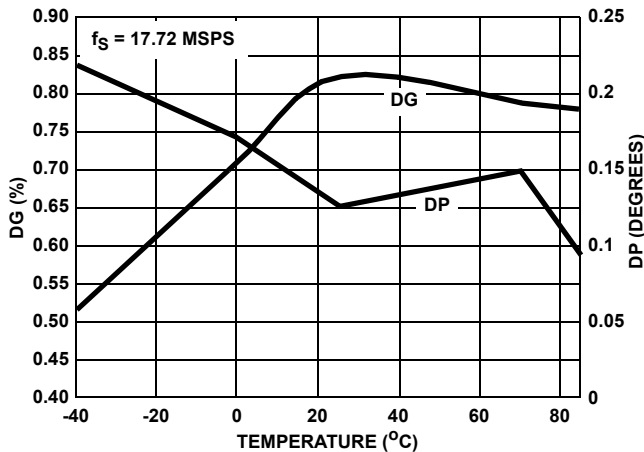

FIGURE 19. DIFFERENTIAL GAIN/PHASE vs TEMPERATURE

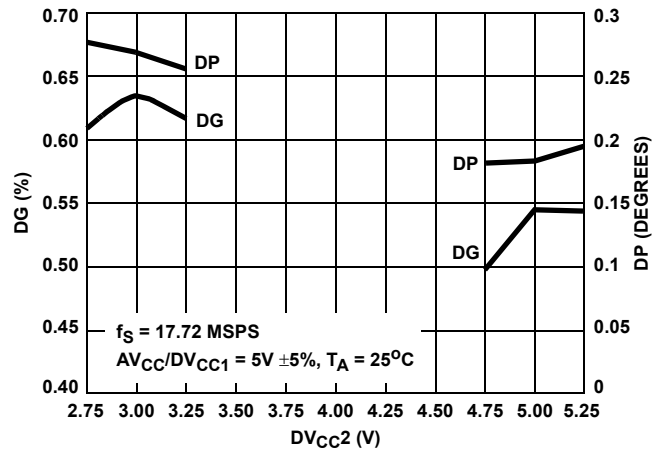

FIGURE 20. DIFFERENTIAL GAIN/PHASE vs SUPPLY VOLTAGE

**Typical Performance Curves** (Continued)

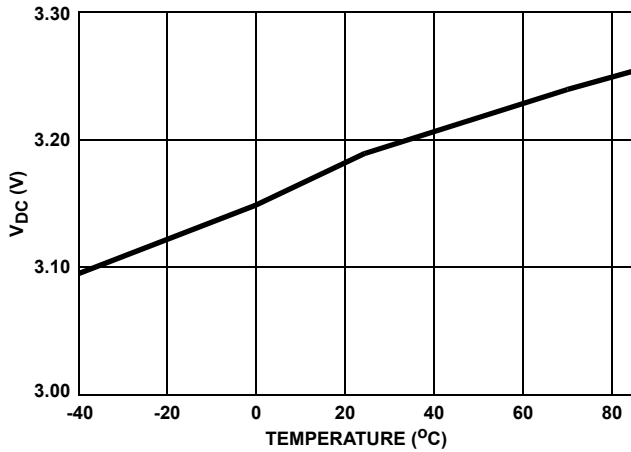

FIGURE 21. DC BIAS VOLTAGE (V<sub>DC</sub>) vs TEMPERATURE

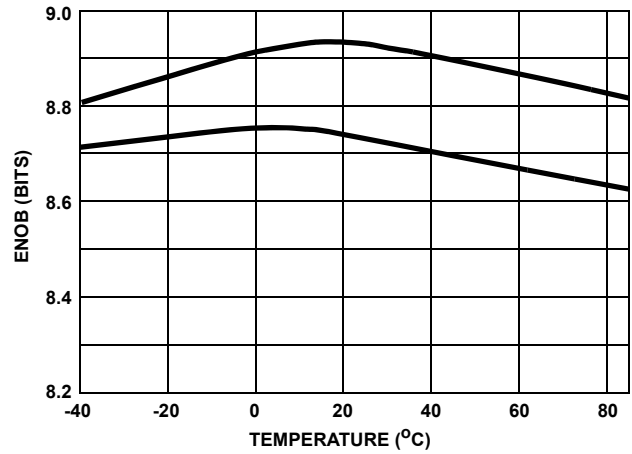

FIGURE 22. EFFECTIVE NUMBER OF BITS F(ENOB) vs TEMPERATURE

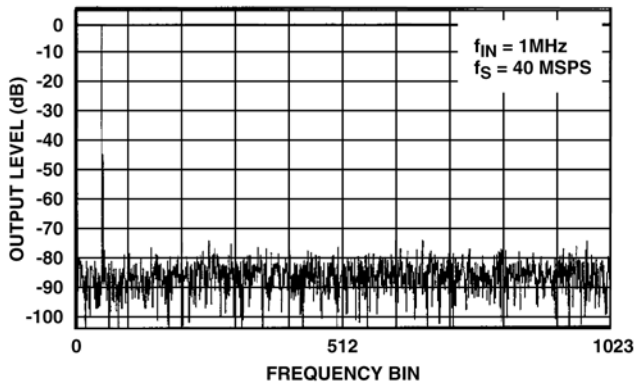

FIGURE 23. 2048 POINT FFT PLOT

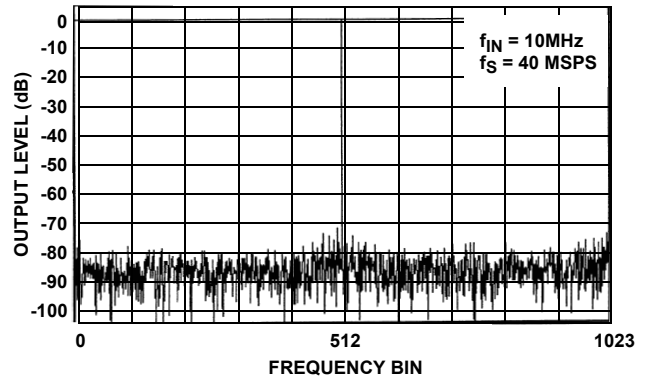

FIGURE 24. 2048 POINT FFT SPECTRAL PLOT

**Detailed Description**

**Theory of Operation**

The HI5746 is a 10-bit fully differential sampling pipeline A/D converter with digital error correction logic. Figure 25 depicts the circuit for the front end differential-in-differential-out sample-and-hold (S/H). The switches are controlled by an internal sampling clock which is a non-overlapping two phase signal,  $\phi_1$  and  $\phi_2$ , derived from the master sampling clock. During the sampling phase,  $\phi_1$ , the input signal is applied to the sampling capacitors,  $C_S$ . At the same time the holding capacitors,  $C_H$ , are discharged to analog ground. At the falling edge of  $\phi_1$  the input signal is sampled on the bottom plates of the sampling capacitors. In the next clock phase,  $\phi_2$ , the two bottom plates of the sampling capacitors are connected together and the holding capacitors are switched to the op amp output nodes. The charge then redistributes between  $C_S$  and  $C_H$  completing one sample-and-hold cycle. The front end sample-and-hold output is a fully-

differential, sampled-data representation of the analog input. The circuit not only performs the sample-and-hold function but will also convert a single-ended input to a fully-differential output for the converter core. During the sampling phase, the  $V_{IN}$  pins see only the on-resistance of a switch and  $C_S$ . The relatively small values of these components result in a typical full power input bandwidth of 250MHz for the converter.

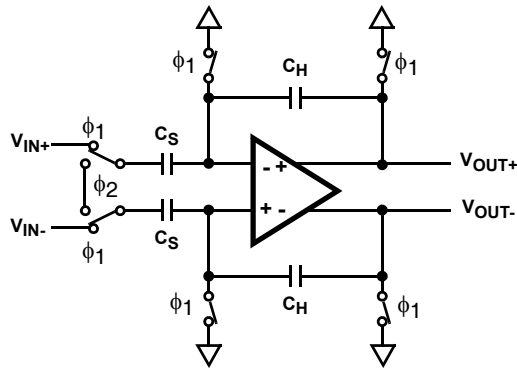

FIGURE 25. ANALOG INPUT SAMPLE-AND-HOLD

As illustrated in the functional block diagram and the timing diagram in Figure 1, eight identical pipeline subconverter stages, each containing a two-bit flash converter and a two-bit multiplying digital-to-analog converter, follow the S/H circuit with the ninth stage being a two bit flash converter. Each converter stage in the pipeline will be sampling in one phase and amplifying in the other clock phase. Each individual subconverter clock signal is offset by 180 degrees from the previous stage clock signal resulting in alternate stages in the pipeline performing the same operation.

The output of each of the eight identical two-bit subconverter stages is a two-bit digital word containing a supplementary bit to be used by the digital error correction logic. The output of each subconverter stage is input to a digital delay line which is controlled by the internal sampling clock. The function of the digital delay line is to time align the digital outputs of the eight identical two-bit subconverter stages with the corresponding output of the ninth stage flash converter before applying the eighteen bit result to the digital error correction logic. The digital error correction logic uses the supplementary bits to correct any error that may exist before generating the final ten bit digital data output of the converter.

Because of the pipeline nature of this converter, the digital data representing an analog input sample is output to the digital data bus on the 7th cycle of the clock after the analog sample is taken. This time delay is specified as the data latency. After the data latency time, the digital data representing each succeeding analog sample is output during the following clock cycle. The digital output data is synchronized to the external sampling clock by a double buffered latching technique. The output of the digital error correction circuit is available in two's complement or offset binary format depending on the state of the Data Format Select (DFS) control input (see Table 1, A/D Code Table).

### Reference Voltage Inputs, $V_{REF-}$ and $V_{REF+}$

The HI5746 is designed to accept two external reference voltage sources at the  $V_{REF}$  input pins. Typical operation of the converter requires  $V_{REF+}$  to be set at +2.5V and  $V_{REF-}$  to be set at 2.0V. However, it should be noted that the input structure

of the  $V_{REF+}$  and  $V_{REF-}$  input pins consists of a resistive voltage divider with one resistor of the divider (nominally 500 $\Omega$ ) connected between  $V_{REF+}$  and  $V_{REF-}$  and the other resistor of the divider (nominally 2000 $\Omega$ ) connected between  $V_{REF-}$  and analog ground. This allows the user the option of supplying only the +2.5V  $V_{REF+}$  voltage reference with the +2.0V  $V_{REF-}$  being generated internally by the voltage division action of the input structure.

The HI5746 is tested with  $V_{REF-}$  equal to +2.0V and  $V_{REF+}$  equal to +2.5V yielding a fully differential analog input voltage range of  $\pm 0.5V$ .  $V_{REF+}$  and  $V_{REF-}$  can differ from the above voltages (see the Typical Performance Curves, Figure 8 through Figure 13).

In order to minimize overall converter noise it is recommended that adequate high frequency decoupling be provided at **both** of the reference voltage input pins,  $V_{REF+}$  and  $V_{REF-}$ .

### Analog Input, Differential Connection

The analog input to the HI5746 is a differential input that can be configured in various ways depending on the signal source and the required level of performance. A fully differential connection (Figure 26 and Figure 27) will give the best performance for the converter.

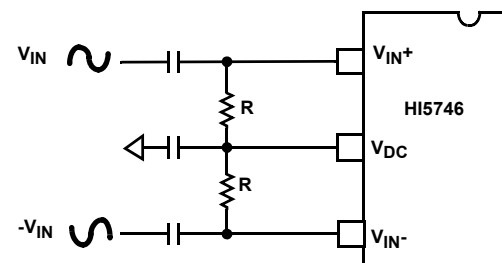

FIGURE 26. AC COUPLED DIFFERENTIAL INPUT

Since the HI5746 is powered by a single +5V analog supply, the analog input is limited to be between ground and +5V. For the differential input connection this implies the analog input common mode voltage can range from 0.25V to 4.75V. The performance of the ADC does not change significantly with the value of the analog input common mode voltage.

A DC voltage source,  $V_{DC}$ , equal to 3.2V (typical), is made available to the user to help simplify circuit design when using an AC coupled differential input. This low output impedance voltage source is not designed to be a reference but makes an excellent DC bias source and stays well within the analog input common mode voltage range over temperature (see the Typical Performance Curves, Figure 21).

For the AC coupled differential input (Figure 26) assume the difference between  $V_{REF+}$ , typically 2.5V, and  $V_{REF-}$ , typically 2.0V, is 0.5V. Full scale is achieved when the  $V_{IN}$  and  $-V_{IN}$  input signals are 0.5V<sub>P-P</sub>, with  $-V_{IN}$  being 180 degrees out of phase with  $V_{IN}$ . The converter will be at

positive full scale when the  $V_{IN+}$  input is at  $V_{DC} + 0.25V$  and the  $V_{IN-}$  input is at  $V_{DC} - 0.25V$  ( $V_{IN+} - V_{IN-} = +0.5V$ ). Conversely, the converter will be at negative fullscale when the  $V_{IN+}$  input is equal to  $V_{DC} - 0.25V$  and  $V_{IN-}$  is at  $V_{DC} + 0.25V$  ( $V_{IN+} - V_{IN-} = -0.5V$ ).

The analog input can be DC coupled (Figure 27) as long as the inputs are within the analog input common mode voltage range ( $0.25V \leq V_{DC} \leq 4.75V$ ).

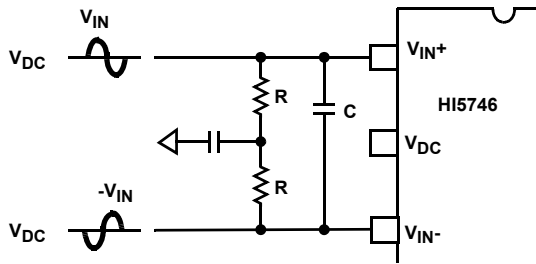

FIGURE 27. DC COUPLED DIFFERENTIAL INPUT

The resistors, R, in Figure 27 are not absolutely necessary but may be used as load setting resistors. A capacitor, C, connected from  $V_{IN+}$  to  $V_{IN-}$  will help filter any high frequency noise on the inputs, also improving performance. Values around 20pF are sufficient and can be used on AC coupled inputs as well. Note, however, that the value of capacitor C chosen must take into account the highest frequency component of the analog input signal.

**Analog Input, Single-Ended Connection**

The configuration shown in Figure 28 may be used with a single ended AC coupled input.

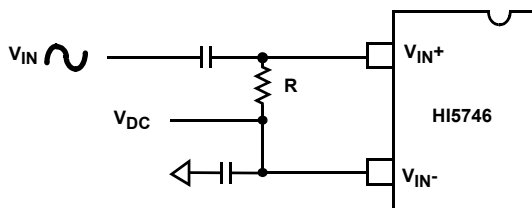

FIGURE 28. AC COUPLED SINGLE ENDED INPUT

Again, assume the difference between  $V_{REF+}$ , typically 2.5V, and  $V_{REF-}$ , typically 2V, is 0.5V. If  $V_{IN}$  is a 1V<sub>P-P</sub> sinewave, then  $V_{IN+}$  is a 1V<sub>P-P</sub> sinewave riding on a positive voltage equal to VDC. The converter will be at positive full scale when  $V_{IN+}$  is at  $V_{DC} + 0.5V$  ( $V_{IN+} - V_{IN-} = +0.5V$ ) and will be at negative full scale when  $V_{IN+}$  is equal to  $V_{DC} - 0.5V$  ( $V_{IN+} - V_{IN-} = -0.5V$ ). Sufficient headroom must be provided such that the input voltage never goes above +5V or below AGND. In this case, VDC could range between 0.5V and 4.5V without a significant change in ADC performance. The simplest way to produce VDC is to use the DC bias source,  $V_{DC}$ , output of the HI5746.

The single ended analog input can be DC coupled (Figure 27) as long as the input is within the analog input common mode voltage range.

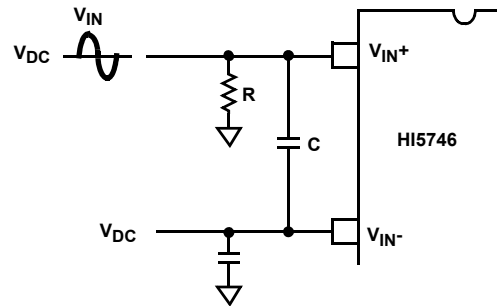

FIGURE 29. DC COUPLED SINGLE ENDED INPUT

The resistor, R, in Figure 29 is not absolutely necessary but may be used as a load setting resistor. A capacitor, C, connected from  $V_{IN+}$  to  $V_{IN-}$  will help filter any high frequency noise on the inputs, also improving performance. Values around 20pF are sufficient and can be used on AC coupled inputs as well. Note, however, that the value of capacitor C chosen must take into account the highest frequency component of the analog input signal.

A single ended source may give better overall system performance if it is first converted to differential before driving the HI5746.

**Digital Output Control and Clock Requirements**

The HI5746 provides a standard high-speed interface to external TTL logic families.

In order to ensure rated performance of the HI5746, the duty cycle of the clock should be held at 50% ±5%. It must also have low jitter and operate at standard TTL levels.

Performance of the HI5746 will only be guaranteed at conversion rates above 1 MSPS. This ensures proper performance of the internal dynamic circuits. Similarly, when power is first applied to the converter, a maximum of 20 cycles at a sample rate above 1 MSPS will have to be performed before valid data is available.

A Data Format Select (DFS) pin is provided which will determine the format of the digital data outputs. When at logic low, the data will be output in offset binary format. When at logic high, the data will be output in two's complement format. Refer to Table 1 for further information.

TABLE 1. A/D CODE TABLE

CODE CENTER DESCRIPTION	DIFFERENTIAL INPUT VOLTAGE ( $V_{IN+} - V_{IN-}$ )	OFFSET BINARY OUTPUT CODE (DFS LOW)										TWO'S COMPLEMENT OUTPUT CODE (DFS HIGH)											
		M S B										L S B	M S B										L S B
			D9	D8	D7	D6	D5	D4	D3	D2	D1			D0	D9	D8	D7	D6	D5	D4	D3	D2	
+Full Scale (+FS) - $\frac{1}{4}$ LSB	0.499756V	1	1	1	1	1	1	1	1	1	1	0	1	1	1	1	1	1	1	1	1		
+FS - $1\frac{1}{4}$ LSB	0.498779V	1	1	1	1	1	1	1	1	1	0	0	1	1	1	1	1	1	1	1	0		
$+\frac{3}{4}$ LSB	732.422 $\mu$ V	1	0	0	0	0	0	0	0	0	0	0	0	0	0	0	0	0	0	0	0		
$-\frac{1}{4}$ LSB	-244.141 $\mu$ V	0	1	1	1	1	1	1	1	1	1	1	1	1	1	1	1	1	1	1	1		
-FS + $1\frac{3}{4}$ LSB	-0.498291V	0	0	0	0	0	0	0	0	0	1	1	0	0	0	0	0	0	0	0	1		
-Full Scale (-FS) + $\frac{3}{4}$ LSB	-0.499268V	0	0	0	0	0	0	0	0	0	0	1	0	0	0	0	0	0	0	0	0		

## NOTES:

8. The voltages listed above represent the ideal center of each output code shown as a function of the reference differential voltage, ( $V_{REF+} - V_{REF-}$ ) = 0.5V.
9.  $V_{REF+} = 2.5V$  and  $V_{REF-} = 2V$ .

The output enable pin,  $\overline{OE}$ , when pulled high will three-state the digital outputs to a high impedance state. Set the  $\overline{OE}$  input to logic low for normal operation.

$\overline{OE}$ INPUT	DIGITAL DATA OUTPUTS
0	Active
1	High Impedance

**Supply and Ground Considerations**

The HI5746 has separate analog and digital supply and ground pins to keep digital noise out of the analog signal path. The digital data outputs also have a separate supply pin,  $DV_{CC2}$ , which can be powered from a 3V or 5V supply. This allows the outputs to interface with 3V logic if so desired.

The part should be mounted on a board that provides separate low impedance connections for the analog and digital supplies and grounds. For best performance, the supplies to the HI5746 should be driven by clean, linear regulated supplies. The board should also have good high frequency decoupling capacitors mounted as close as possible to the converter. If the part is powered off a single supply then the analog supply should be isolated with a ferrite bead from the digital supply.

Refer to the application note "Using Intersil High Speed A/D Converters" (AN9214) for additional considerations when using high speed converters.

**Static Performance Definitions****Offset Error ( $V_{OS}$ )**

The midscale code transition should occur at a level  $\frac{1}{4}$  LSB above half-scale. Offset is defined as the deviation of the actual code transition from this point.

**Full-Scale Error (FSE)**

The last code transition should occur for an analog input that is  $\frac{3}{4}$  LSB below positive Full scale (+FS) with the offset error removed. Fullscale error is defined as the deviation of the actual code transition from this point.

**Differential Linearity Error (DNL)**

DNL is the worst case deviation of a code width from the ideal value of 1 LSB.

**Integral Linearity Error (INL)**

INL is the worst case deviation of a code center from a best fit straight line calculated from the measured data.

**Power Supply Sensitivity**

Each of the power supplies are moved plus and minus 5% and the shift in the offset and full scale error (in LSBs) is noted.

**Dynamic Performance Definitions**

Fast Fourier Transform (FFT) techniques are used to evaluate the dynamic performance of the HI5746. A low distortion sine wave is applied to the input, it is coherently sampled, and the output is stored in RAM. The data is then transformed into the frequency domain with an FFT and analyzed to evaluate the dynamic performance of the A/D. The sine wave input to the part is -0.5dB down from Fullscale for all these tests.

SNR and SINAD are quoted in dB. The distortion numbers are quoted in dBc (decibels with respect to carrier) and **DO NOT** include any correction factors for normalizing to full scale.

### **Effective Number Of Bits (ENOB)**

The effective number of bits (ENOB) is calculated from the SINAD data by:

$$\text{ENOB} = (\text{SINAD} - 1.76 + V_{\text{CORR}}) / 6.02,$$

where:  $V_{\text{CORR}} = 0.5 \text{ dB}$ .

$V_{\text{CORR}}$  adjusts the SINAD, and hence the ENOB, for the amount the analog input signal is below fullscale.

### **Signal To Noise and Distortion Ratio (SINAD)**

SINAD is the ratio of the measured RMS signal to RMS sum of all the other spectral components below the Nyquist frequency,  $f_S/2$ , excluding DC.

### **Signal To Noise Ratio (SNR)**

SNR is the ratio of the measured RMS signal to RMS noise at a specified input and sampling frequency. The noise is the RMS sum of all of the spectral components below  $f_S/2$  excluding the fundamental, the first five harmonics and DC.

### **Total Harmonic Distortion (THD)**

THD is the ratio of the RMS sum of the first 5 harmonic components to the RMS value of the fundamental input signal.

### **2nd and 3rd Harmonic Distortion**

This is the ratio of the RMS value of the applicable harmonic component to the RMS value of the fundamental input signal.

### **Spurious Free Dynamic Range (SFDR)**

SFDR is the ratio of the fundamental RMS amplitude to the RMS amplitude of the next largest spectral component in the spectrum below  $f_S/2$ .

### **Intermodulation Distortion (IMD)**

Nonlinearities in the signal path will tend to generate intermodulation products when two tones,  $f_1$  and  $f_2$ , are present at the inputs. The ratio of the measured signal to the distortion terms is calculated. The terms included in the calculation are  $(f_1+f_2)$ ,  $(f_1-f_2)$ ,  $(2f_1)$ ,  $(2f_2)$ ,  $(2f_1+f_2)$ ,  $(2f_1-f_2)$ ,  $(f_1+2f_2)$ ,  $(f_1-2f_2)$ . The ADC is tested with each tone 6dB below full scale.

### **Transient Response**

Transient response is measured by providing a full scale transition to the analog input of the ADC and measuring the number of cycles it takes for the output code to settle within 10-bit accuracy.

### **Over-Voltage Recovery**

Over-Voltage Recovery is measured by providing a full scale transition to the analog input of the ADC which overdrives the input by 200mV, and measuring the number of cycles it takes for the output code to settle within 10-bit accuracy.

### **Full Power Input Bandwidth (FPBW)**

Full power input bandwidth is the analog input frequency at which the amplitude of the digitally reconstructed output has decreased 3dB below the amplitude of the input sine wave. The input sine wave has an amplitude which swings from -FS to +FS. The bandwidth given is measured at the specified sampling frequency.

### **Video Definitions**

Differential Gain and Differential Phase are two commonly found video specifications for characterizing the distortion of a chrominance signal as it is offset through the input voltage range of an ADC.

### **Differential Gain (DG)**

Differential Gain is the peak difference in chrominance amplitude (in percent) relative to the reference burst.

### **Differential Phase (DP)**

Differential Phase is the peak difference in chrominance phase (in degrees) relative to the reference burst.

### **Timing Definitions**

Refer to Figure 1 and Figure 2 for these definitions.

### **Aperture Delay ( $t_{AP}$ )**

Aperture delay is the time delay between the external sample command (the falling edge of the clock) and the time at which the signal is actually sampled. This delay is due to internal clock path propagation delays.

### **Aperture Jitter ( $t_{AJ}$ )**

Aperture jitter is the RMS variation in the aperture delay due to variation of internal clock path delays.

### **Data Hold Time ( $t_H$ )**

Data hold time is the time to where the previous data (N - 1) is no longer valid.

### **Data Output Delay Time ( $t_{OD}$ )**

Data output delay time is the time to where the new data (N) is valid.

### **Data Latency ( $t_{LAT}$ )**

After the analog sample is taken, the digital data representing an analog input sample is output to the digital data bus on the 7th cycle of the clock after the analog sample is taken. This is due to the pipeline nature of the converter where the analog sample has to ripple through the internal subconverter stages. This delay is specified as the data latency. After the data latency time, the digital data representing each succeeding analog sample is output during the following clock cycle. The digital data lags the analog input sample by 7 sample clock cycles.

### **Power-Up Initialization**

This time is defined as the maximum number of clock cycles that are required to initialize the converter at power-up. The requirement arises from the need to initialize the dynamic circuits within the converter.

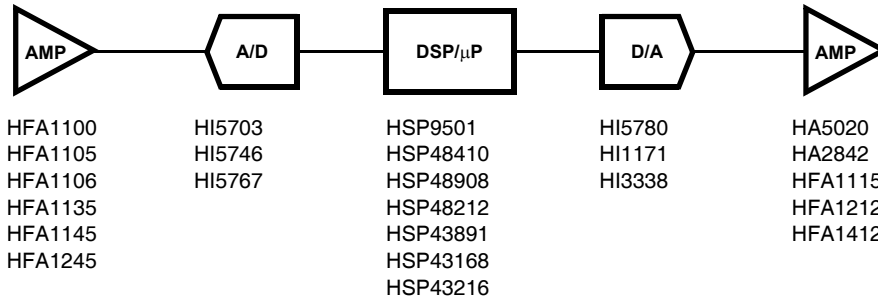

- |   |   |
|---|---|
| HFA1100: 850MHz Video Op Amp  | HSP48212: Digital Video Mixer                                       |
| HFA1105: 300MHz Video Op Amp  | HSP43891: Digital Filter, 30MHz, 9-Bit                              |
| HFA1106: 250MHz Video Op Amp with Bandwidth Limit Control           | HSP43168: Dual FIR Filter, 10-Bit, 33MHz/45MHz                      |
| HFA1135: 350MHz Video Op Amp with Output Limiting                   | HSP43216: Digital Half Band Filter                                  |
| HFA1145: 300MHz Video Op Amp with Output Disable                    | HI5780: 10-Bit, 80 MSPS, Video D/A Converter                        |
| HFA1245: Dual, 350MHz, Video Op Amp with Output Disable             | HI1171: 8-Bit, 40 MSPS, Video D/A Converter                         |
| HI5703: 10-Bit, 40 MSPS, Low Power A/D Converter                    | HI3338: 8-Bit, 50 MSPS, Video D/A Converter                         |
| HI5746: 10-Bit, 40 MSPS, Very Low Power A/D Converter               | HA5020: 100MHz Video Op Amp   |
| HI5767: 10-Bit, 40 MSPS A/D Converter with Voltage Reference        | HA2842: High Output Current, Video Op Amp                           |
| HSP9501: Programmable Data Buffer                                   | HFA1115: 225MHz Programmable Gain Video Buffer with Output Limiting |
| HSP48410: Histogrammer/Accumulating Buffer, 10-Bit Pixel Resolution | HFA1212: 350MHz Dual Programmable Gain Video Buffer                 |
| HSP48908: 2-D Convolver, 3 x 3 Kernal Convolution, 8-Bit            | HFA1412: 350MHz Quad Programmable Gain Video Buffer                 |

In addition, CMOS Logic Families in HC/HCT, AC/ACT, FCT and CD4000 are available.

**FIGURE 30. 10-BIT VIDEO IMAGING COMPONENTS**

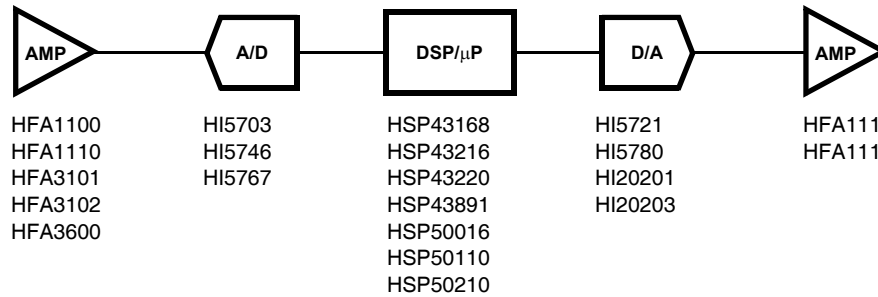

- |   |
|---|
| HFA1100: 850MHz Op Amp  |
| HFA1110: 750MHz Unity Gain Video Buffer                             |
| HFA3101: Gilbert Cell Transistor Array                              |
| HFA3102: Dual Long-Tailed Pair Transistor Array                     |
| HFA3600: Low Noise Amplifier/Mixer                                  |
| HI5703: 10-Bit, 40 MSPS, Low Power A/D Converter                    |
| HI5746: 10-Bit, 40 MSPS, Very Low Power A/D Converter               |
| HI5767: 10-Bit, 40 MSPS A/D Converter with Voltage Reference        |
| HSP43168: Dual FIR Filter, 10-Bit, 33MHz/45MHz                      |
| HSP43216: Digital Half Band Filter                                  |
| HSP43220: Decimating Digital Filter                                 |
| HSP43891: Digital Filter, 30MHz, 9-Bit                              |
| HSP50016: Digital Down Converter                                    |
| HSP50110: Digital Quadrature Tuner                                  |
| HSP50210: Digital Costas Loop                                       |
| HI5721: 10-Bit, 100 MSPS, Communications D/A Converter              |
| HI5780: 10-Bit, 80 MSPS, D/A Converter                              |
| HI20201: 10-Bit, 160 MSPS, High Speed D/A Converter                 |
| HI20203: 8-Bit, 160 MSPS, High Speed D/A Converter                  |
| HFA1112: 850MHz Programmable Gain Video Buffer                      |
| HFA1113: 850MHz Programmable Gain Video Buffer with Output Limiting |

In addition, CMOS Logic Families in HC/HCT, AC/ACT, FCT and CD4000 are available.

**FIGURE 31. 10-BIT COMMUNICATIONS COMPONENTS**