

# Staggered Connector Directly Mounted on Board

## HIF2C Series

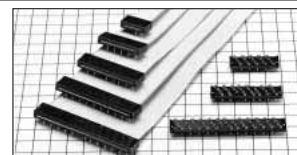
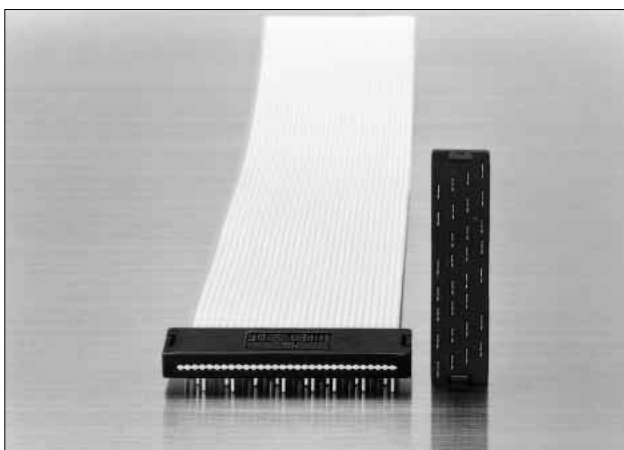

### ■ Features

- 1. Directly Mounted on Board**  
This connector can be directly mounted on the board using 1.27mm pitch flat cable.
- 2. Variation in Number of Contacts**  
The number of contacts contains 10, 16, 20, 26, 30, 34, 40, 50, and 60 contacts.
- 3. Low Profile Type**  
The connector height is lower than that of the HIF2E series.
- 4. Applicable Cable**  
The applicable cable is UL2651 AWG#28 flat cable (7 cores/.0.127mm, jacket dia. :0.8 to 1.0mm).

### ■ Applications

Computers, terminal equipment, PPC, various kinds of electronic equipment, business machines, etc.

### ■ Product Specifications

Rating	Current rating: 1A Voltage rating: 200V AC	Operating Temperature Range:-55 to +85°C (Note 1) Operating Moisture Range:40 to 80%	Storage Temperature Range:-10 to +60°C(Note 2) Storage Humidity Range:40 to 70% (Note 2)
--------	-----------------------------------------------	-----------------------------------------------------------------------------------------	---------------------------------------------------------------------------------------------

Item	Specification	Condition
1. Insulation Resistance	1000M ohms min.	500V DC
2. Withstanding voltage	No flashover or insulation breakdown.	650V AC/1 minute
3. Contact Resistance	15m ohms max.	0.1A
4. Vibration	No electrical discontinuity of 1μs or more	Frequency: 10 to 55 Hz, single amplitude of 0.75 mm, 2 hours in each of the 3 directions.
5. Humidity (Steady state)	Insulation resistance: 1000M ohms min.	96 hours at temperature of 40°C and humidity of 90% to 95%
6. Temperature Cycle	No damage, cracks, or parts looseness.	(-65°C: 30 minutes →15 to 35°C: 5 minutes max. 125°C: 30 minutes →15 to 35°C: 5 minutes max.) 5 cycles
7. Resistance to Soldering heat	No deformation of components affecting performance.	Solder Bath: 260°C for 10 seconds
		Manual soldering: 360°C for 5 seconds

Note 1: Includes temperature rise caused by current flow.

Note 2: The term "storage" refers to products stored for long period of time prior to mounting and use. Operating Temperature Range and Humidity range covers non conducting condition of installed connectors in storage, shipment or during transportation.

Note 3. Information contained in this catalog represents general requirements for this Series. Contact us for the drawings and specifications for a specific part number shown.

### ■ Material

Part	Material	Finish	Remarks
Insulator	PBT	Black	UL94V-0
Contact	Beryllium copper	Contact area Gold plated over nickel underplated	—

### ■ Ordering Information

**HIF2C** - \* **DT** - **1.27 R**  
 ①                      ②                      ③                      ④                      ⑤

① Series Name: HIF 2C	④ Contact Pitch: 1.27mm
② Number of contacts: 10, 16, 20, 26, 30, 34, 40, 50, and 60	⑤ Connection type : R : ribbon cable
③ Contact alignment: DT : staggered	

HIF2C Series Staggered Connector Directly Mounted on Board

Part Number	CL No.	Number of Contacts	A	B	RoHS
HIF2C-10DT-1.27R(01)	561-0075-0-01	10	17.8	11.43	YES
HIF2C-16DT-1.27R(01)	561-0077-6-01	16	25.4	19.05	
HIF2C-20DT-1.27R(01)	561-0079-1-01	20	30.5	24.13	
HIF2C-26DT-1.27R(01)	561-0081-3-01	26	38.1	31.75	
HIF2C-30DT-1.27R(01)	561-0083-9-01	30	43.2	36.83	
HIF2C-34DT-1.27R(01)	561-0085-4-01	34	48.3	41.91	
HIF2C-40DT-1.27R(01)	561-0087-0-01	40	55.9	49.53	
HIF2C-50DT-1.27R(01)	561-0089-5-01	50	68.6	62.23	
HIF2C-60DT-1.27R(01)	561-0091-7-01	60	81.3	74.93	

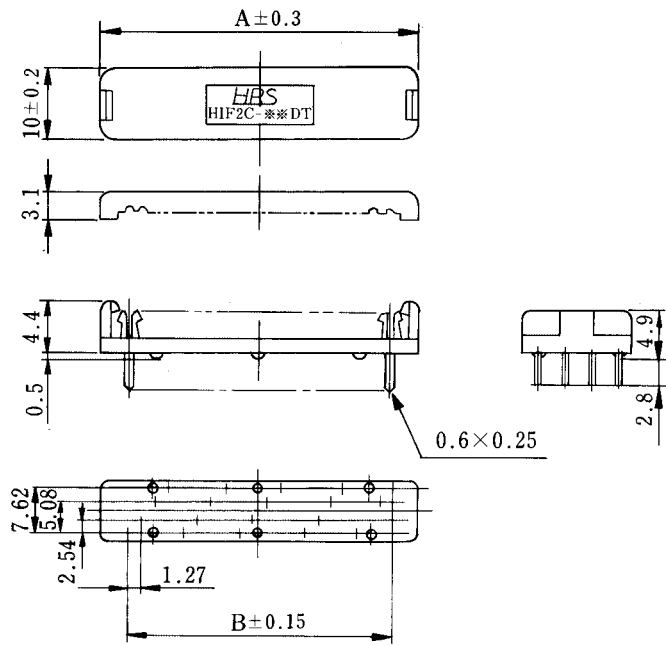

## ◆PCB mounting pattern

### 10 contacts

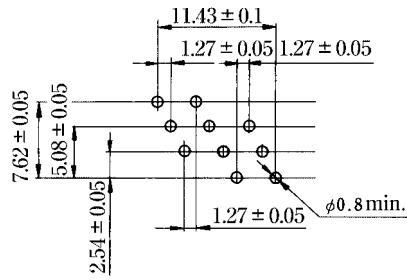

### 16 contacts

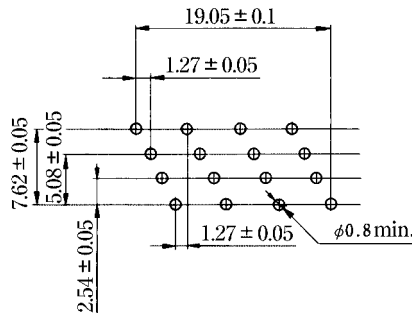

### 20 contacts

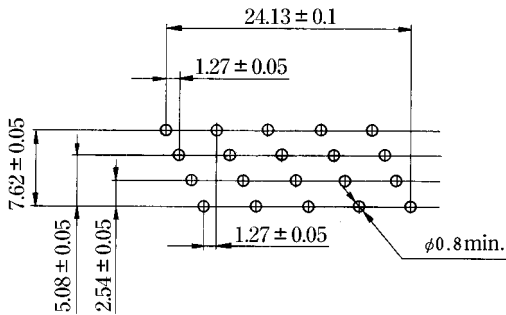

### 26 contacts

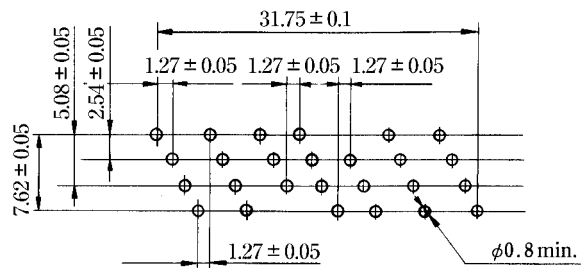

### 30 contacts

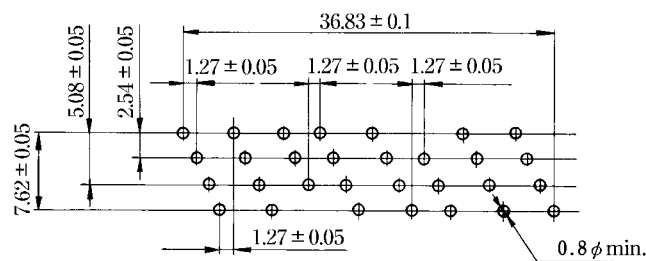

HIP2C Series Staggered Connector Directly Mounted on Board

## ◆PCB mounting pattern

### 34 contacts

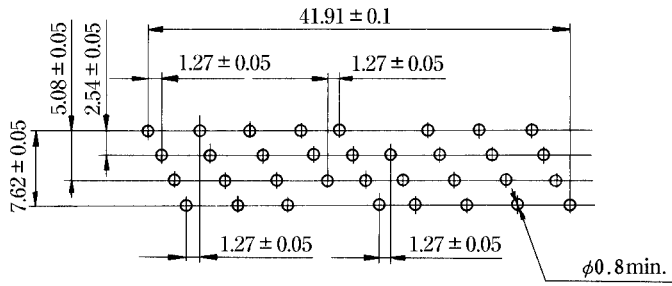

### 40 contacts

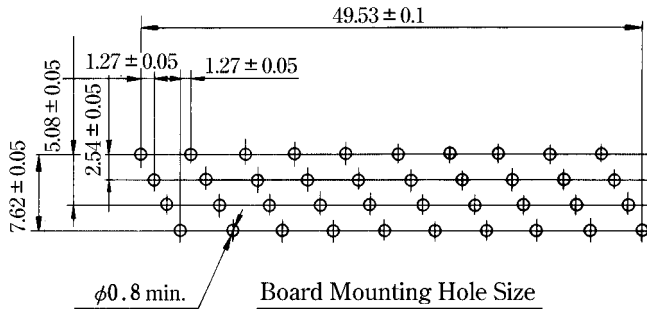

### 50 contacts

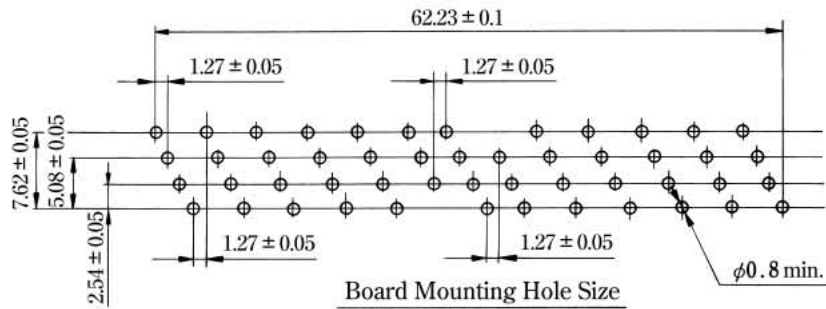

### 60 contacts

