

OBSOLETE PRODUCT
 Contact factory for replacement model

HL01R

1 WATT REGULATED DC/DC CONVERTER

FEATURES

- LOW COST
- NON-CONDUCTIVE CASE
- INTERNAL INPUT AND OUTPUT FILTERING
- SHORT CIRCUIT PROTECTED

- BUILT IN STANDOFFS
- INDUSTRY STANDARD PINOUT

The HL01R Series uses advanced circuit design and packaging technology to realize superior reliability and performance. A 125kHz push-pull oscillator is used in the input stage. Beat-frequency oscillator problems are reduced when using the HL01R Series with high frequency isolation amplifiers.

Reduced parts count and all surface mount construction add to the reliability of the HL01R Series. The use of surface

DESCRIPTION

mount devices and magnetics eliminate hand soldering operations. This "hands-free" construction increases quality and reliability while keeping cost low.

ABSOLUTE MAXIMUM RATINGS

Internal Power Dissipation.....	1.2W
Short Circuit Duration.....	Continuous*
Lead Temperature (soldering, 10 seconds max).....	+300°C*

* Note: Refer to Reflow Profile for SMD Models.

ORDERING INFORMATION

	HL01R	xyzz	Y/Z	/H
Device Family	HL01R			
HL Indicates DC/DC Converter				
Model Number	xyzz			
Where:				
xx = Input Voltage				
y = Number or Outputs (Single "S", Dual "D")				
zz = Output Voltage				
Package Option	Y/Z			
Screening Option	H			
DIP Package only				

Specifications typical at $T_A = +25^\circ\text{C}$, nominal input voltage, rated output current unless otherwise specified.

TYPICAL PERFORMANCE CURVES

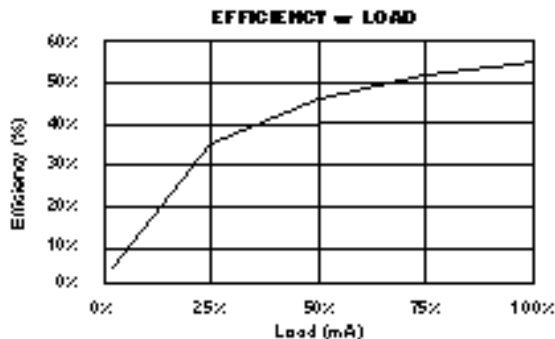

ELECTRICAL SPECIFICATIONS

Specifications typical at $T_A = +25^{\circ}\text{C}$, nominal input voltage, rated output current unless otherwise specified.

OUTPUT VOLTAGE MODEL	OUTPUT VOLTAGE (VDC)	CURRENT (VDC)	MIN LOAD (mA)	RATED LOAD EFFICIENCY (%)			
				(mA)	(mA)		
HL01R05S05	5	5	200	50	400	58	
HL01R05S12	5	12	83	50	400	52	
HL01R05S15	5	15	67	50	400	52	
HL01R12S05	12	5	200	40	160	58	
HL01R12S12	12	12	83	40	160	52	
HL01R12S15	12	15	67	40	160	52	
HL01R15S05	15	5	200	30	130	58	
HL01R15S12	15	12	83	30	130	52	
HL01R15S15	15	15	67	30	130	52	
HL01R24S05	24	5	200	20	80	58	
HL01R24S12	24	12	83	20	80	52	
HL01R24S15	24	15	67	20	80	52	
HL01R05D05	5	± 5	± 100	50	425	45	
HL01R05D12	5	± 12	± 41	50	400	53	
HL01R05D15	5	± 15	± 33	50	400	53	
HL01R12D05	12	± 5	± 100	40	185	45	
HL01R12D12	12	± 12	± 41	40	160	53	
HL01R12D15	12	± 15	± 33	40	160	53	
HL01R15D05	15	± 5	± 100	30	145	45	
HL01R15D12	15	± 12	± 41	30	130	53	
HL01R15D15	15	± 15	± 33	30	130	53	
HL01R24D05	24	± 5	± 100	20	90	45	
HL01R24D12	24	± 12	± 41	20	80	53	
HL01R24D15	24	± 15	± 33	20	80	53	
PARAMETER		CONDITIONS		MIN	TYP	MAX	UNITS
INPUT							

Note: Other input to output voltages may be available. Please contact factory.

COMMON SPECIFICATIONS

Specifications typical at $T_A = +25^{\circ}\text{C}$, nominal input voltage, rated output current unless otherwise specified.

Voltage Range		4.75	5	5.25	VDC
		11.4	12	12.6	VDC
		14.25	15	15.75	VDC
Reflected Ripple Current		22.8	24	25.2	VDC
			30	100	mAp-p
ISOLATION					
Rated Voltage		500			VDC
Test Voltage	60 Hz, 10 Seconds	500			Vpk
Resistance			1		G Ω
Capacitance			25		pF
Leakage Current	$V_{ISO} = 240\text{VAC}, 60\text{Hz}$		2	10	μArms
OUTPUT					
Rated Power			1		W
Voltage Setpoint Accuracy			± 3	± 5	%
Temperature Coefficient			± 0.01	± 0.02	%/ $^{\circ}\text{C}$
Ripple & Noise	BW = DC to 10MHz		30	100	mVp-p
	BW = 10Hz to 2MHz		1	10	mVrms
Line Regulation	High Line to Low Line		± 0.1	± 0.3	%
Load Regulation	Rated Load to No Load		± 0.3	± 0.5	%
GENERAL					
Switching Frequency			125		kHz
Package Weight			10		g
MTTF per MIL-HDBK-217, Rev. F	Circuit Stress Method				
Ground Benign			675		kHr
TEMPERATURE					
Specification		-25		+70	$^{\circ}\text{C}$
Operation		-40		+85	$^{\circ}\text{C}$
Storage		-40		+110	$^{\circ}\text{C}$

MECHANICAL Package/Pinout "Y" and "Z"

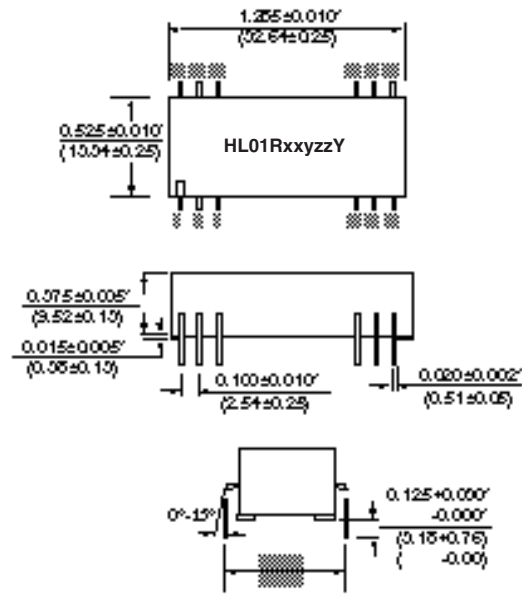

DIP PACKAGE

TOP VIEWS

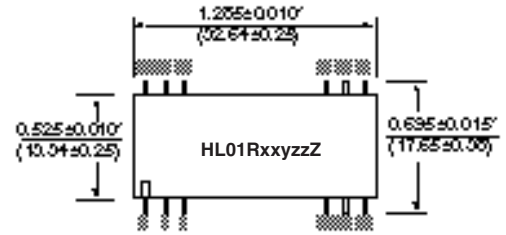

SIDE VIEWS

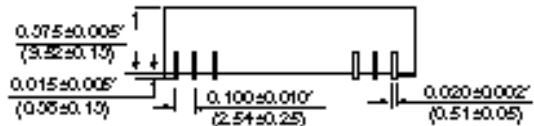

END VIEWS

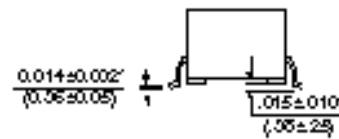

SMD PACKAGE

NU = Do Not Use.

NC = No Internal Connection.

Duplicate pin functions are internally connected.

All dimensions are in inches (millimeters).

GRID: 0.100 inches (2.54 millimeters)

Typically Marked with: specific model ordered, date code, job code and Logo.

PIN CONNECTIONS		
PIN#	SINGLES	DUALS
1	+VIN	+VIN
2	NU	-VOUT
3	Common	Common
10	-VOUT	Common
11	+VOUT	+VIN
12	-VIN	-VOUT
13	-VIN	-VIN
14	+VOUT	+VOUT
15	-VOUT	Common
22	NU	Common
23	NU	-VOUT
24	+VIN	+VIN

RECOMMENDED LAND PATTERN

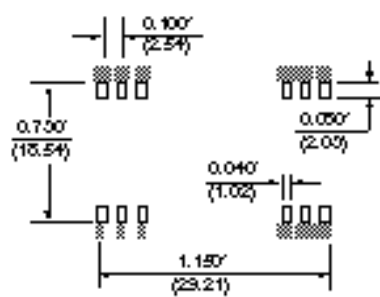

RECOMMENDED REFLOW PROFILE

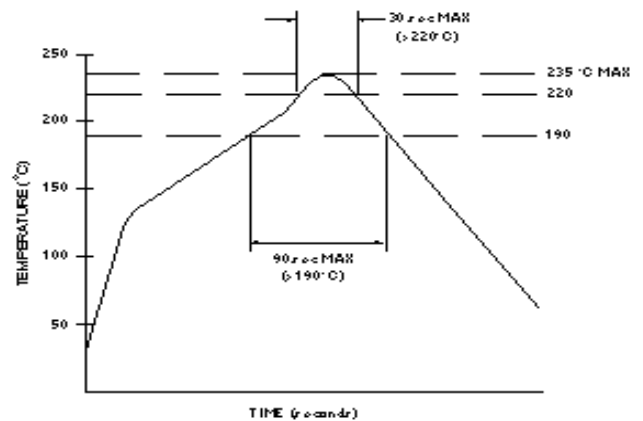



Murata Power Solutions, Inc.

11 Cabot Boulevard, Mansfield, MA 02048-1151 U.S.A.

Tel: (508) 339-3000 (800) 233-2765 Fax: (508) 339-6356

www.murata-ps.com email: sales@murata-ps.com ISO 9001 & ISO 14001 REGISTERED

Murata Power Solutions, Inc. makes no representation that the use of its products in the circuits described herein, or the use of other technical information contained herein, will not infringe upon existing or future patent rights. The descriptions contained herein do not imply the granting of licenses to make, use, or sell equipment constructed in accordance therewith. Specifications are subject to change without notice.
© 2008 Murata Power Solutions, Inc.

USA: Mansfield (MA), Tel: (508) 339 3000, email: sales@murata-ps.com
Canada: Toronto, Tel: (866) 740 1232, email: toronto@murata-ps.com
UK: Milton Keynes, Tel: +44 (0)1908 615232, email: mk@murata-ps.com
France: Montigny Le Bretonneux, Tel: +33 (0)1 34 60 01 01, email: france@murata-ps.com
Germany: München, Tel: +49 (0)89-544334-0, email: ped.munich@murata-ps.com
Japan: Tokyo, Tel: 3-3779-1031, email: sales_tokyo@murata-ps.com
Osaka, Tel: 6-6354-2025, email: sales_osaka@murata-ps.com
China: Shanghai, Tel: +86 215 027 3678, email: shanghai@murata-ps.com
Guangzhou, Tel: +86 208 221 8066, email: guangzhou@murata-ps.com
Singapore: Parkway Centre, Tel: +65 6348 9096, email: singapore@murata-ps.com