

# HM628128A Series

131,072-word  $\times$  8-bit High Speed CMOS Static RAM

# HITACHI

Rev. X  
January 1995

The Hitachi HM628128A is a CMOS static RAM organized 128 kword  $\times$  8 bit. It realizes higher density, higher performance and low power consumption by employing 0.8  $\mu$ m Hi-CMOS process technology.

It offers low power standby power dissipation; therefore, it is suitable for battery back-up systems. The device, packaged in a 525-mil SOP (460-mil body SOP) or a 600-mil plastic DIP, or a 8  $\times$  20 mm TSOP with thickness of 1.2 mm, is available for high density mounting. TSOP package is suitable for cards, and reverse type TSOP is also provided.

## Features

- High speed
  - Fast access time: 55/70/85/100 ns (max)
- Low power
  - Active: 75 mW (typ)
  - Standby: 10  $\mu$ W (typ)
- Single 5 V supply
- Completely static memory
  - No clock or timing strobe required
- Equal access and cycle times
- Common data input and output
  - Three state output
- Directly TTL compatible
  - All inputs and outputs
- Capability of battery back up operation
  - 2 chip selection for battery back up

---

## HM628128A Series

---

### Ordering Information

Type No.	Access time	Package	Type No.	Access time	Package
HM628128ALP-5	55 ns	600-mil 32-pin plastic DIP (DP-32)	HM628128ALT-5	55 ns	8 mm × 20 mm 32-pin TSOP (normal type) (TFP-32D)
HM628128ALP-7	70 ns				
HM628128ALP-8	85 ns				
HM628128ALP-10	100 ns				
HM628128ALP-5L	55 ns		HM628128ALT-5L	55 ns	
HM628128ALP-7L	70 ns		HM628128ALT-7L	70 ns	
HM628128ALP-8L	85 ns		HM628128ALT-8L	85 ns	
HM628128ALP-10L	100 ns		HM628128ALT-10L	100 ns	
HM628128ALP-5SL	55 ns		HM628128ALT-5SL	55 ns	
HM628128ALP-7SL	70 ns		HM628128ALT-7SL	70 ns	
HM628128ALP-8SL	85 ns		HM628128ALT-8SL	85 ns	
HM628128ALP-10SL	100 ns		HM628128ALT-10SL	100 ns	
HM628128ALFP-5	55 ns	525-mil 32-pin plastic SOP (FP-32D)	HM628128ALR-5	55 ns	8 mm × 20 mm 32-pin TSOP (reverse type) (TFP-32DR)
HM628128ALFP-7	70 ns				
HM628128ALFP-8	85 ns				
HM628128ALFP-10	100 ns				
HM628128ALFP-5L	55 ns		HM628128ALR-5L	55 ns	
HM628128ALFP-7L	70 ns		HM628128ALR-7L	70 ns	
HM628128ALFP-8L	85 ns		HM628128ALR-8L	85 ns	
HM628128ALFP-10L	100 ns		HM628128ALR-10L	100 ns	
HM628128ALFP-5SL	55 ns		HM628128ALR-5SL	55 ns	
HM628128ALFP-7SL	70 ns		HM628128ALR-7SL	70 ns	
HM628128ALFP-8SL	85 ns		HM628128ALR-8SL	85 ns	
HM628128ALFP-10SL	100 ns		HM628128ALR-10SL	100 ns	

---

**Pin Arrangement**

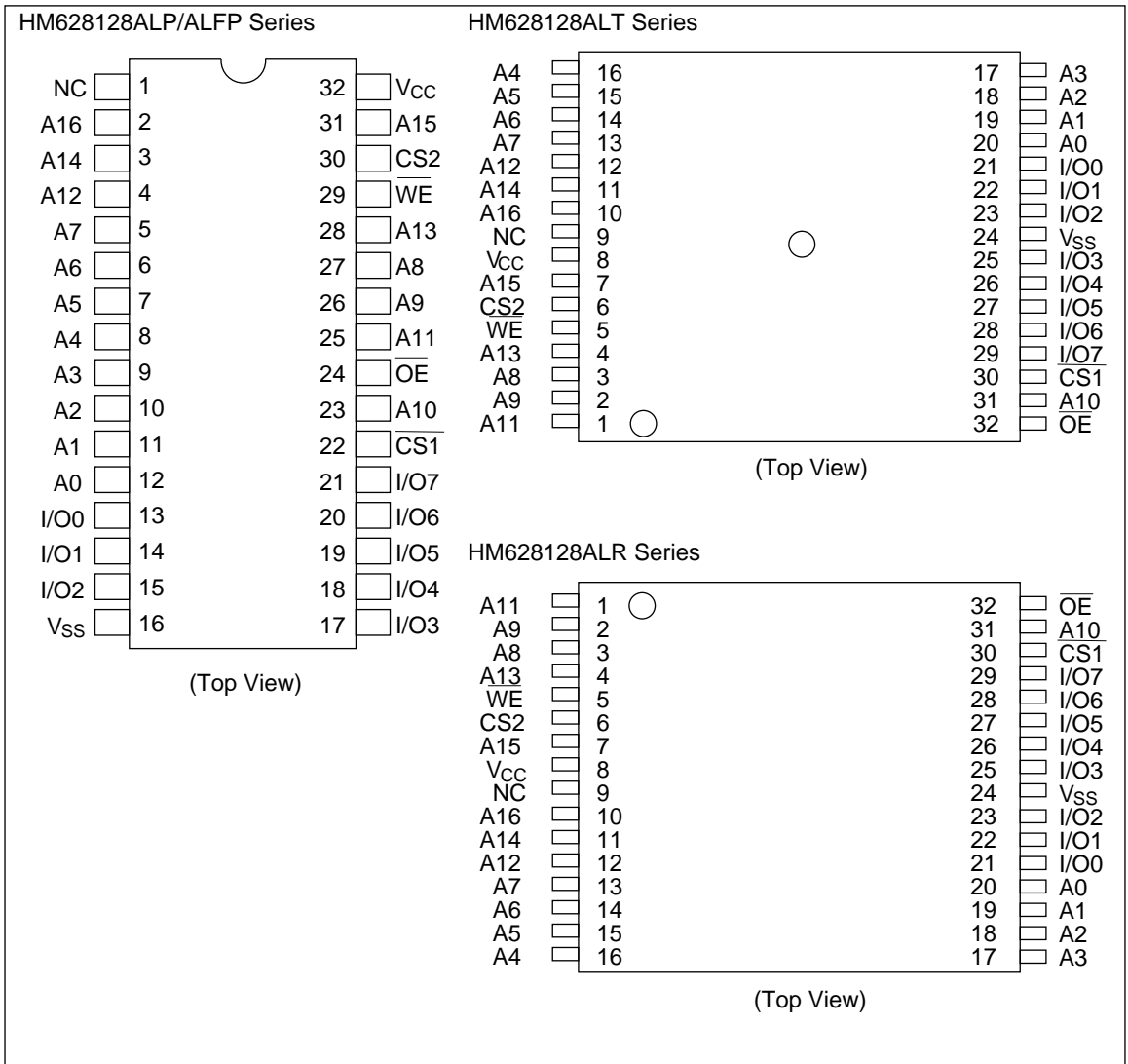

**Pin Description**

Pin name	Function
A0 – A16	Address
I/O0 – I/O7	Input/output
CS1	Chip select 1
CS2	Chip select 2
WE	Write enable

Pin name	Function
OE	Output enable
NC	No connection
V <sub>CC</sub>	Power supply
V <sub>SS</sub>	Ground

# HM628128A Series

## Block Diagram

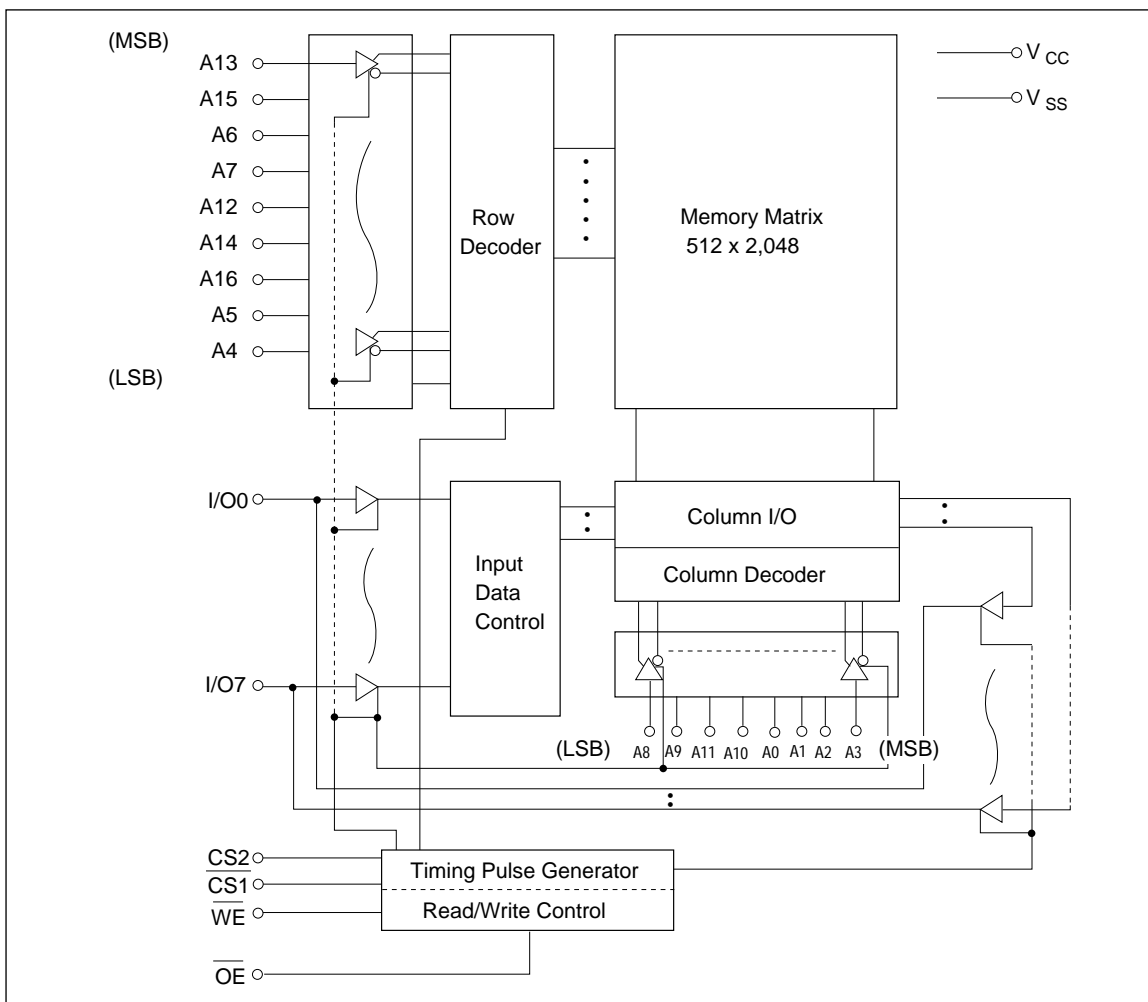

## Function Table

$\overline{CS1}$	$\overline{CS2}$	$\overline{OE}$	$\overline{WE}$	Mode	$V_{CC}$ current	I/O pin	Ref. cycle
H	X	X	X	Standby	$I_{SB}, I_{SB1}$	High-Z	—
X	L	X	X	Standby	$I_{SB}, I_{SB1}$	High-Z	—
L	H	H	H	Output disable	$I_{CC}$	High-Z	—
L	H	L	H	Read	$I_{CC}$	Dout	Read cycle
L	H	H	L	Write	$I_{CC}$	Din	Write cycle (1)
L	H	L	L	Write	$I_{CC}$	Din	Write cycle (2)

Note: X: H or L

**Absolute Maximum Ratings**

Parameter	Symbol	Value	Unit
Supply voltage relative to $V_{SS}$	$V_{CC}$	-0.5 to +7.0	V
Voltage on any pin relative to $V_{SS}$ <sup>*1</sup>	$V_T$	-0.5 <sup>*2</sup> to $V_{CC} + 0.3$ <sup>*3</sup>	V
Power dissipation	$P_T$	1.0	W
Operating temperature	$T_{opr}$	0 to +70	°C
Storage temperature	$T_{stg}$	-55 to +125	°C
Storage temperature under bias	$T_{bias}$	-10 to +85	°C

- Note: 1. With respect to  $V_{SS}$   
 2. -3.0 V for pulse half-width  $\leq 30$  ns  
 3. Maximum voltage is 7.0V.

**Recommended DC Operating Conditions ( $T_a = 0$  to +70°C)**

Parameter	Symbol	Min	Typ	Max	Unit
Supply voltage	$V_{CC}$	4.5	5.0	5.5	V
	$V_{SS}$	0	0	0	V
Input voltage (HM628128A-7/8/10)	$V_{IH}$	2.2	—	$V_{CC} + 0.3$	V
	$V_{IL}$	-0.3 <sup>*1</sup>	—	0.8	V
Input voltage (HM628128A-5)	$V_{IH}$	2.4	—	$V_{CC} + 0.3$	V
	$V_{IL}$	-0.3 <sup>*1</sup>	—	0.8	V

- Note: 1. -3.0 V for pulse half-width  $\leq 30$  ns

## HM628128A Series

### DC Characteristics (Ta = 0 to +70°C, VCC = 5 V ± 10%, VSS = 0 V)

Parameter	Symbol	Min	Typ*1	Max	Unit	Test conditions
Input leakage current	$ I_{LI} $	—	—	1.0	μA	Vin = VSS to VCC
Output leakage current	$ I_{LO} $	—	—	1.0	μA	$\overline{CS1} = V_{IH}$ or $CS2 = V_{IL}$ or $\overline{OE} = V_{IH}$ or $\overline{WE} = V_{IL}$ , V <sub>I/O</sub> = VSS to VCC
Operating power supply current: DC	I <sub>CC</sub>	—	15	30	mA	$\overline{CS1} = V_{IL}$ , CS2 = V <sub>IH</sub> , Others = V <sub>IH</sub> /V <sub>IL</sub> I <sub>I/O</sub> = 0 mA
Operating power supply current	I <sub>CC1</sub> (HM628128 A-7/8/10)	—	45	70	mA	Min cycle, duty = 100%, $\overline{CS1} = V_{IL}$ , CS2 = V <sub>IH</sub> , Others = V <sub>IH</sub> /V <sub>IL</sub> I <sub>I/O</sub> = 0 mA
	I <sub>CC1</sub> (HM628128 A-5)	—	50	80	mA	I <sub>I/O</sub> = 0 mA
	I <sub>CC2</sub>	—	15	25	mA	Cycle time = 1 μs, duty = 100%, I <sub>I/O</sub> = 0 mA, $\overline{CS1} \leq 0.2$ V, CS2 ≥ VCC - 0.2 V V <sub>IH</sub> ≥ VCC - 0.2 V, V <sub>IL</sub> ≤ 0.2 V
Standby power supply current: DC	I <sub>SB</sub>	—	1	2	mA	(1) $\overline{CS1} = V_{IH}$ , CS2 = V <sub>IH</sub> or (2) CS2 = V <sub>IL</sub>
Standby power supply current (1): DC	I <sub>SB1</sub> (L version)	—	2	100	μA	0 V ≤ Vin ≤ VCC , (1) $\overline{CS1} \geq V_{CC} - 0.2$ V, CS2 ≥ VCC - 0.2 V or
	I <sub>SB1</sub> (L-L/L-SL version)	—	2	50	μA	(2) 0 V ≤ CS2 ≤ 0.2 V
Output voltage	V <sub>OL</sub>	—	—	0.4	V	I <sub>OL</sub> = 2.1 mA
	V <sub>OH</sub>	2.4	—	—	V	I <sub>OH</sub> = -1.0 mA

Note: 1. Typical values are at VCC = 5.0 V, Ta = +25°C and specified loading.

### Capacitance (Ta = 25°C, f = 1.0 MHz)\*1

Parameter	Symbol	Min	Typ	Max	Unit	Test conditions
Input capacitance	Cin	—	—	8	pF	Vin = 0 V
Input/output capacitance	C <sub>I/O</sub>	—	—	10	pF	V <sub>I/O</sub> = 0 V

Note: 1. This parameter is sampled and not 100% tested.

**AC Characteristics** ( $T_a = 0$  to  $+70^\circ\text{C}$ ,  $V_{CC} = 5\text{ V} \pm 10\%$ , unless otherwise noted.)

**Test Conditions**

- Input pulse levels: 0.8 V to 2.4 V (HM628128A-7/8/10)  
0 V to 3 V (HM628128A-5)
- Input rise and fall times: 5 ns
- Input and output timing reference levels: 1.5 V
- Output load: 1 TTL Gate and CL (100 pF) (HM628128A-7/8/10)  
1 TTL Gate and CL (30 pF) (HM628128A-5) (Including scope & jig)

**Read Cycle**

Parameter	Symbol	HM628128A								Unit	Notes
		-5		-7		-8		-10			
		Min	Max	Min	Max	Min	Max	Min	Max		
Read cycle time	$t_{RC}$	55	—	70	—	85	—	100	—	ns	
Address access time	$t_{AA}$	—	55	—	70	—	85	—	100	ns	
Chip selection to output valid	$t_{CO1}$ $t_{CO2}$	—	55	—	70	—	85	—	100	ns	
Output enable to output valid	$t_{OE}$	—	30	—	35	—	45	—	50	ns	
Chip selection to output in low-Z	$t_{LZ1}$ $t_{LZ2}$	5	—	10	—	10	—	10	—	ns	2, 3
Output enable to output in low-Z	$t_{OLZ}$	5	—	5	—	5	—	5	—	ns	2, 3
Chip deselection to output in high-Z	$t_{HZ1}$ $t_{HZ2}$	0	20	0	25	0	30	0	35	ns	1, 2, 3
Output disable to output in high-Z	$t_{OHZ}$	0	20	0	25	0	30	0	35	ns	1, 2, 3
Output hold from address change	$t_{OH}$	5	—	10	—	10	—	10	—	ns	

# HM628128A Series

## Read Timing Waveform \*4

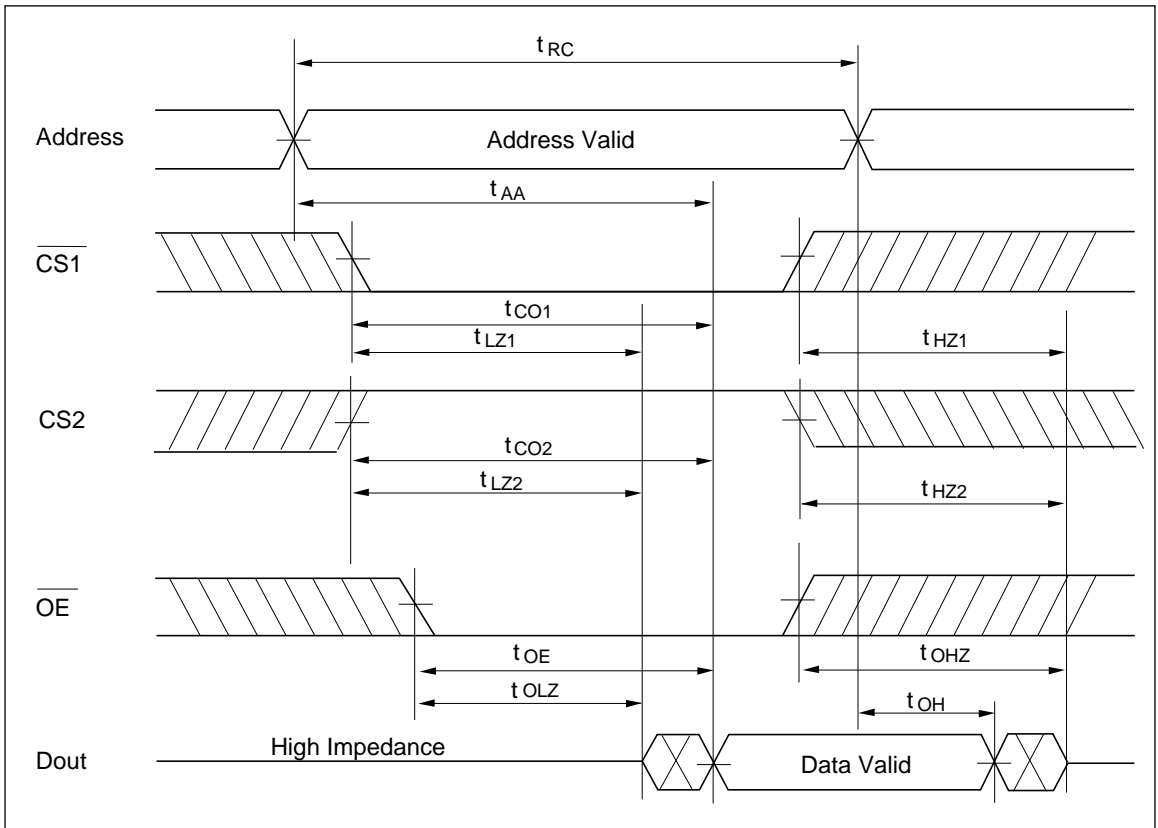

- Notes:
1.  $t_{HZ}$  and  $t_{OHZ}$  are defined as the time at which the outputs achieve the open circuit conditions and are not referred to output voltage levels.
  2. At any given temperature and voltage condition,  $t_{HZ}$  max is less than  $t_{LZ}$  min both for a given device and from device to device.
  3. This parameter is sampled and not 100% tested.
  4.  $\overline{WE}$  is high for read cycle.



Write Cycle

Parameter	Symbol	HM628128A								Unit	Notes
		-5		-7		-8		-10			
		Min	Max	Min	Max	Min	Max	Min	Max		
Write cycle time	$t_{WC}$	55	—	70	—	85	—	100	—	ns	
Chip selection to end of write	$t_{CW}$	50	—	60	—	75	—	80	—	ns	
Address setup time	$t_{AS}$	0	—	0	—	0	—	0	—	ns	
Address valid to end of write	$t_{AW}$	50	—	60	—	75	—	80	—	ns	
Write pulse width	$t_{WP}$	40	—	50	—	55	—	60	—	ns	
Write recovery time	$t_{WR}$	0	—	0	—	0	—	0	—	ns	
Write to output in high-Z	$t_{WHZ}$	0	20	0	25	0	30	0	35	ns	10
Data to write time overlap	$t_{DW}$	25	—	30	—	35	—	40	—	ns	
Data hold from write time	$t_{DH}$	0	—	0	—	0	—	0	—	ns	
Output active from end of write	$t_{OW}$	5	—	5	—	5	—	5	—	ns	10

# HM628128A Series

## Write Timing Waveform (1) ( $\overline{\text{OE}}$ Clock)

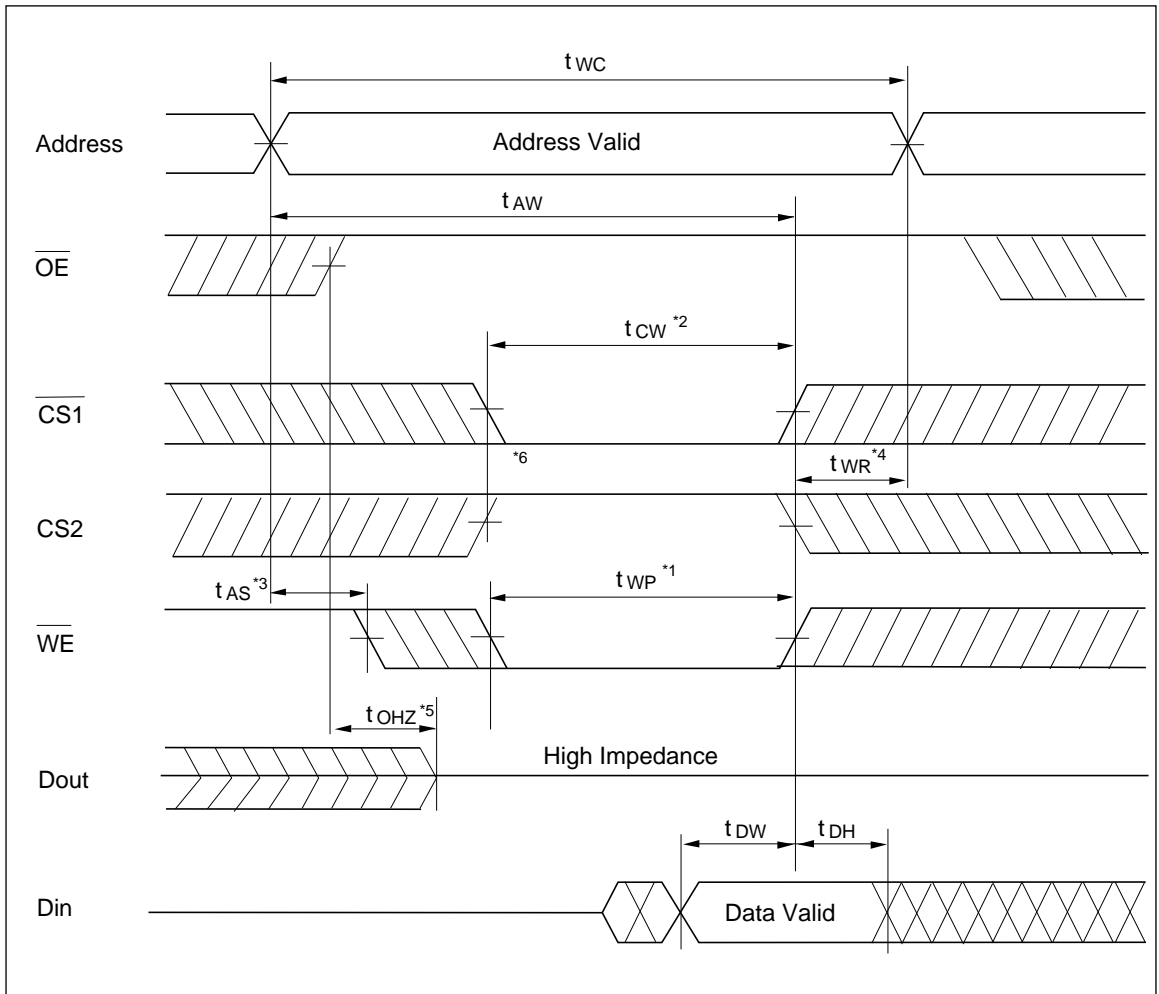

Write Timing Waveform (2) ( $\overline{OE}$  low Fixed)

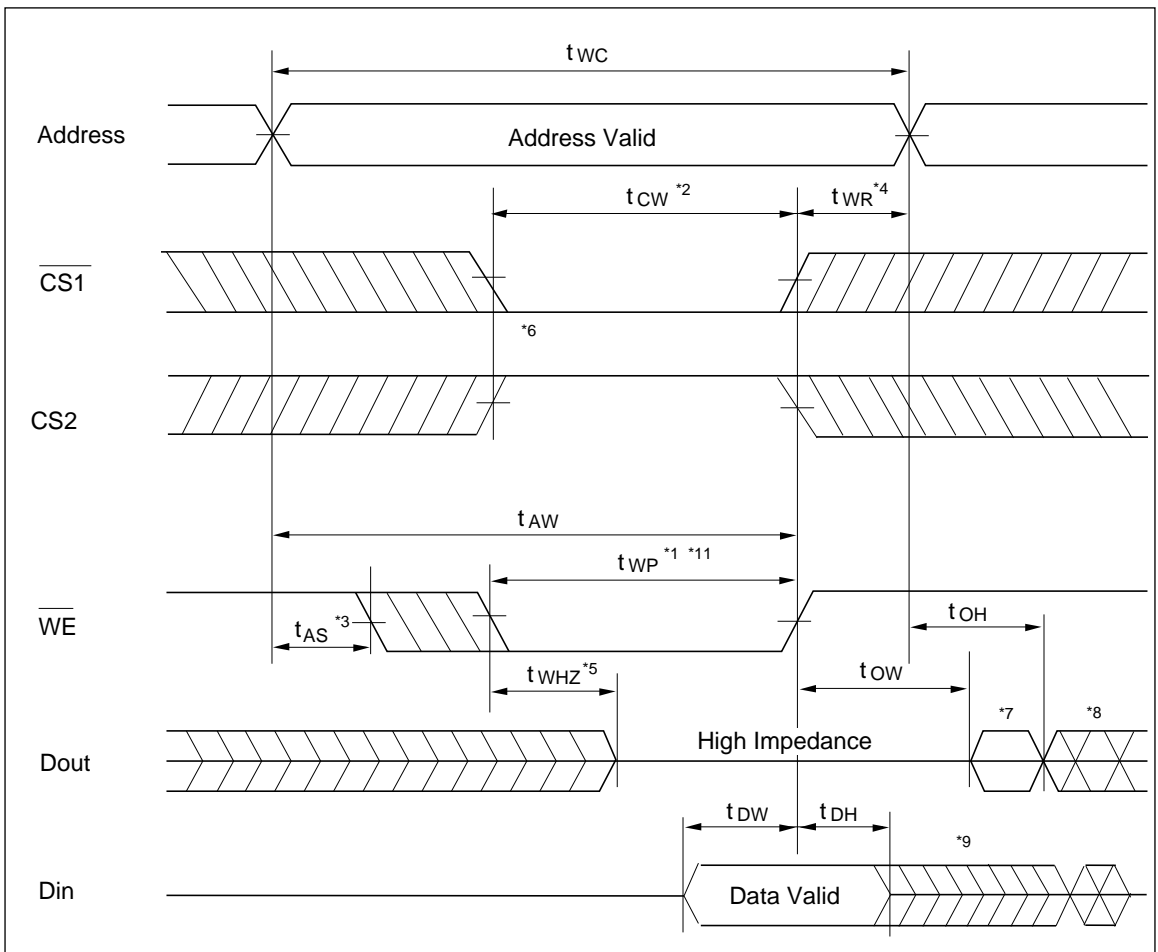

- Notes:
1. A write occurs during the overlap of a low  $\overline{CS1}$ , a high  $\overline{CS2}$ , and a low  $\overline{WE}$ . A write begins at the latest transition among  $\overline{CS1}$  going low,  $\overline{CS2}$  going high, and  $\overline{WE}$  going low. A write ends at the earliest transition among  $\overline{CS1}$  going high,  $\overline{CS2}$  going low, and  $\overline{WE}$  going high.  $t_{WP}$  is measured from the beginning of write to the end of write.
  2.  $t_{CW}$  is measured from the later of  $\overline{CS1}$  going low or  $\overline{CS2}$  going high to the end of write.
  3.  $t_{AS}$  is measured from the address valid to the beginning of write.
  4.  $t_{WR}$  is measured from the earliest of  $\overline{CS1}$  or  $\overline{WE}$  going high or  $\overline{CS2}$  going low to the end of write cycle.
  5. During this period, I/O pins are in the output state; therefore, the input signals of the opposite phase to the outputs must not be applied.
  6. If the  $\overline{CS1}$  goes low simultaneously with  $\overline{WE}$  going low or after the  $\overline{WE}$  going low, the outputs remain in a high impedance state.
  7.  $Dout$  is the same phase of the latest written data in this write cycle.
  8.  $Dout$  is the read data of next address.
  9. If  $\overline{CS1}$  is low and  $\overline{CS2}$  high during this period, I/O pins are in the output state. Therefore, the input signals of opposite phase to the outputs must not be applied to them.
  10. This parameter is sampled and not 100% tested.
  11. In the write cycle with  $\overline{OE}$  low fixed,  $t_{WP}$  must satisfy the following equation to avoid a problem of

# HM628128A Series

data bus contention.  
 $t_{WP} \geq t_{DW \text{ min}} + t_{WHZ \text{ max}}$

## Low $V_{CC}$ Data Retention Characteristics ( $T_a = 0$ to $+70^\circ\text{C}$ )

Parameter	Symbol	Min	Typ	Max	Unit	Test conditions*4
$V_{CC}$ for data retention	$V_{DR}$	2.0	—	—	V	$\overline{CS1} \geq V_{CC} - 0.2 \text{ V}$ , $CS2 \geq V_{CC} - 0.2 \text{ V}$ or $0 \text{ V} \leq CS2 \leq 0.2 \text{ V}$ $V_{in} > 0 \text{ V}$
Data retention current	$I_{CCDR}$ (L version)	—	1	$50^{*1}$	$\mu\text{A}$	$V_{CC} = 3.0 \text{ V}$ , $V_{in} \geq 0 \text{ V}$ $\overline{CS1} \geq V_{CC} - 0.2 \text{ V}$ $CS2 \geq V_{CC} - 0.2 \text{ V}$ or $0 \text{ V} \leq CS2 \leq 0.2 \text{ V}$
	$I_{CCDR}$ (L-L version)	—	1	$30^{*2}$	$\mu\text{A}$	
	$I_{CCDR}$ (L-SL version)	—	1	$15^{*3}$	$\mu\text{A}$	
Chip deselect to data retention time	$t_{CDR}$	0	—	—	ns	See retention waveform
Operation recovery time	$t_R$	5	—	—	ms	

### Low $V_{CC}$ Data Retention Timing Waveform (1) ( $\overline{CS1}$ Controlled)

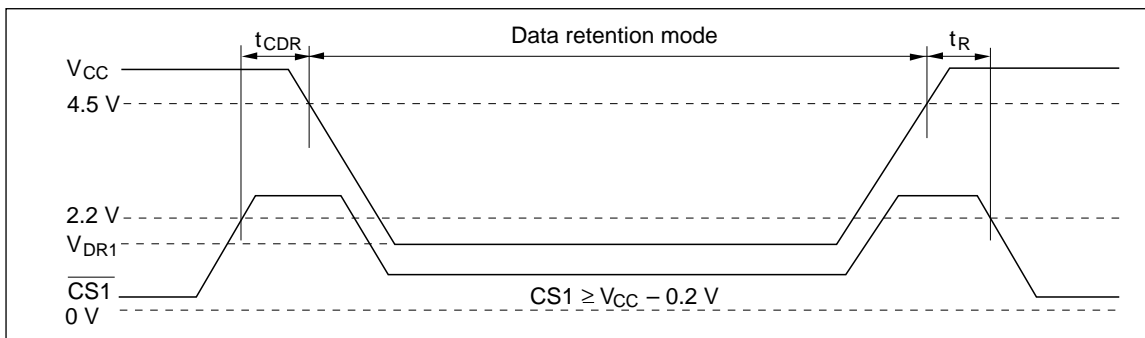

### Low $V_{CC}$ Data Retention Timing Waveform (2) ( $CS2$ Controlled)

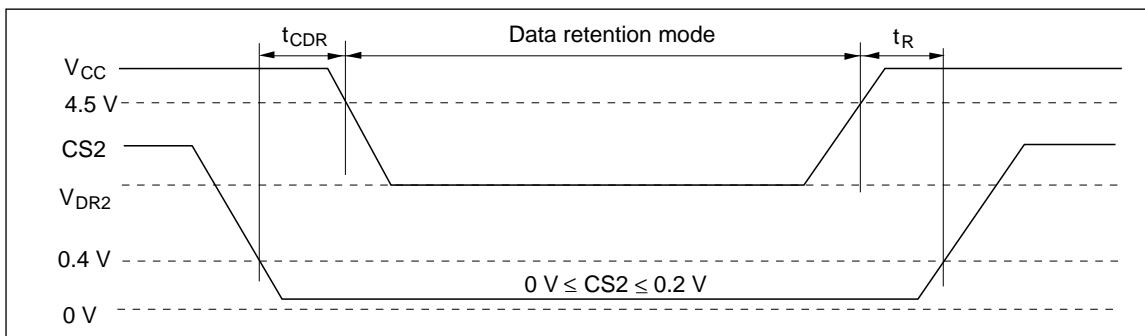

- Notes:
1. 20  $\mu\text{A}$  max at  $T_a = 0$  to  $40^\circ\text{C}$  (L-version).
  2. 6  $\mu\text{A}$  max at  $T_a = 0$  to  $40^\circ\text{C}$  (L-L-version).
  3. 3  $\mu\text{A}$  max at  $T_a = 0$  to  $40^\circ\text{C}$  (L-SL-version).
  4. CS2 controls address buffer,  $\overline{\text{WE}}$  buffer,  $\overline{\text{CS1}}$  buffer,  $\overline{\text{OE}}$  buffer, and Din buffer. If CS2 controls data retention mode, Vin levels (address,  $\overline{\text{WE}}$ ,  $\overline{\text{OE}}$ ,  $\overline{\text{CS1}}$ , I/O) can be in the high impedance state. If  $\overline{\text{CS1}}$  controls data retention mode, CS2 must be  $\text{CS2} \geq V_{\text{CC}} - 0.2 \text{ V}$  or  $0 \text{ V} \leq \text{CS2} \leq 0.2 \text{ V}$ . The other input levels (address,  $\overline{\text{WE}}$ ,  $\overline{\text{OE}}$ , I/O) can be in the high impedance state.