

GaAs MMIC SMT PASSIVE FREQUENCY DOUBLER, 0.7 - 2.4 GHz INPUT

Typical Applications

The HMC156C8 is suitable for:

- Wireless Local Loop
- LMDS, VSAT, and Pt to Pt Radios
- UNII & HiperLAN
- Test Equipment

Features

Conversion Loss: 15 dB

Fo, 3Fo, 4Fo Isolation: 38 dB

Input Drive Level: 10 to 20 dBm

Functional Diagram

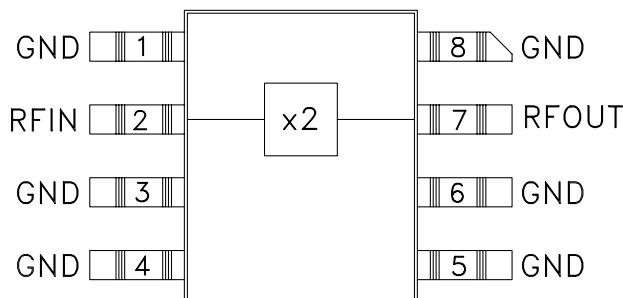

General Description

The HMC156C8 is a miniature frequency doubler in a non-hermetic ceramic surface mount package. Suppression of undesired fundamental and higher order harmonics is 38 dB typical with respect to input signal levels. The doubler uses the same diode/balun technology used in Hittite MMIC mixers, features small size and requires no DC bias.

Electrical Specifications, $T_A = +25^\circ C$, As a Function of Drive Level

Parameter	Input = +10 dBm			Input = +15 dBm			Input = +20 dBm			Units
	Min.	Typ.	Max.	Min.	Typ.	Max.	Min.	Typ.	Max.	
Frequency Range, Input	1.1 - 2.1			0.8 - 2.4			0.7 - 2.3			GHz
Frequency Range, Output	2.2 - 4.2			1.6 - 4.8			1.4 - 4.6			GHz
Conversion Loss		17	22		15	20		15	20	dB
FO Isolation (with respect to input level)	42	47		43	47		27	35		dB
3FO Isolation (with respect to input level)	45	55		44	55		29	40		dB
4FO Isolation (with respect to input level)	28	38		31	38		25	35		dB

GaAs MMIC SMT FREQUENCY DOUBLER, 0.7 - 2.4 GHz INPUT

Conversion Gain vs. Drive Level

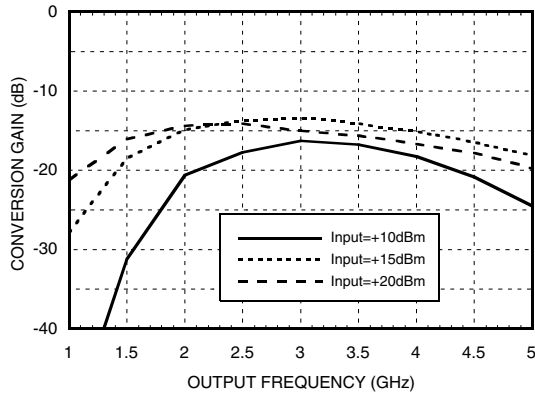

Isolation @ +15 dBm Drive Level*

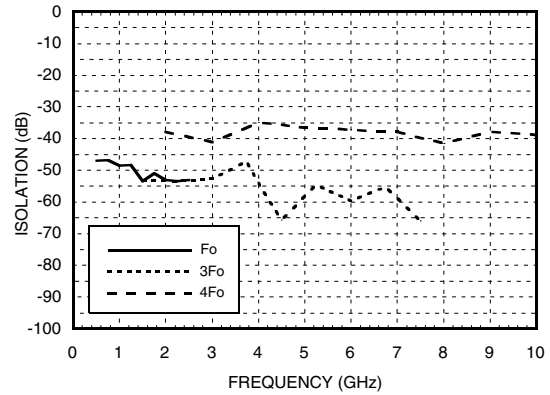

*With respect to input level

Input Return Loss vs. Drive Level

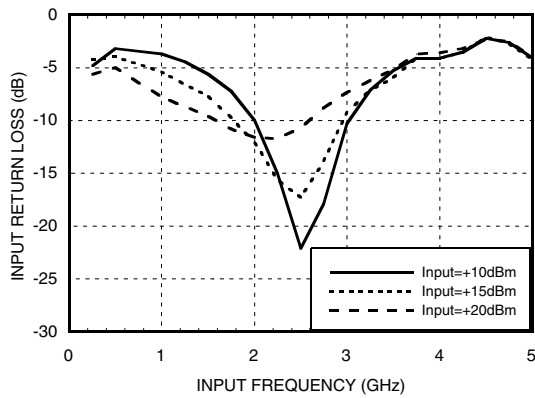

Output Return Loss @ +15 Drive Level

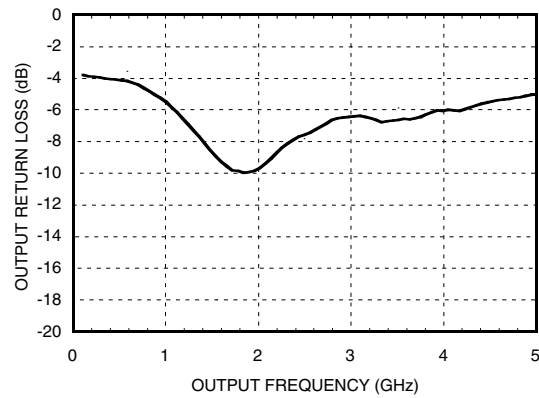

GaAs MMIC SMT FREQUENCY DOUBLER, 0.7 - 2.4 GHz INPUT

Absolute Maximum Ratings

Input Drive	+27 dBm
Storage Temperature	-65 to +150 °C
Operating Temperature	-40 to +85 °C

Outline Drawing

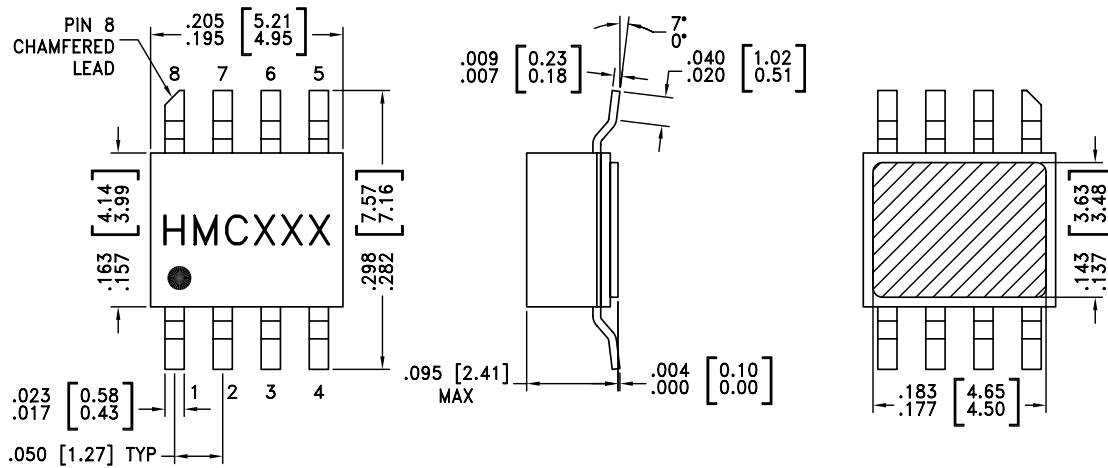

NOTES:

1. PACKAGE BODY MATERIAL: WHITE ALUMINA 92%
2. LEAD, PACKAGE BOTTOM MATERIAL: COPPER
3. PLATING: ELECTROLYTIC GOLD 100 - 200 MICROINCHES OVER ELECTROLYTIC NICKEL 100 TO 200 MICROINCHES.
4. DIMENSIONS ARE IN INCHES [MILLIMETERS].
5. PACKAGE LENGTH AND WIDTH DIMENSIONS DO NOT INCLUDE LID SEAL PROTRUSION .005 PER SIDE.
6. ALL GROUND LEADS AND GROUND PADDLE MUST BE SOLDERED TO PCB PF GROUND.

GaAs MMIC SMT FREQUENCY DOUBLER, 0.7 - 2.4 GHz INPUT

Evaluation PCB

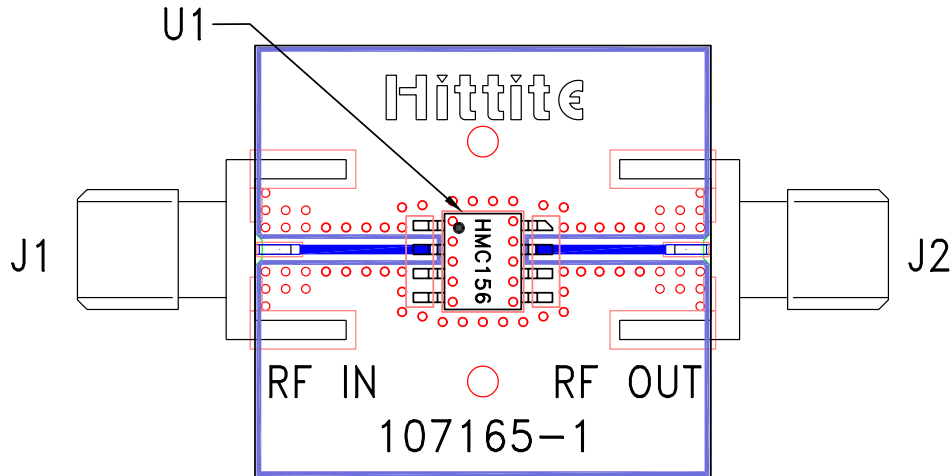

List of Materials

Item	Description
J1, J2	PC Mount SMA Connector
U1	HMC156C8, Doubler
PCB*	107165 Eval Board
* Circuit Board Material: Rogers 4350	

The circuit board used in the final application should be generated with proper RF circuit design techniques. Signal lines should have 50 ohm impedance while the package ground leads and exposed paddle should be connected directly to the ground plane similar to that shown. The evaluation circuit board shown is available from Hittite upon request.