

GaAs MMIC VOLTAGE-VARIABLE ATTENUATOR, 0.8 - 2.0 GHz

Typical Applications

The HMC173MS8 is ideal for 0.8 - 2.0 GHz Applications:

- Base Station Infrastructure
- Portable Wireless

Functional Diagram

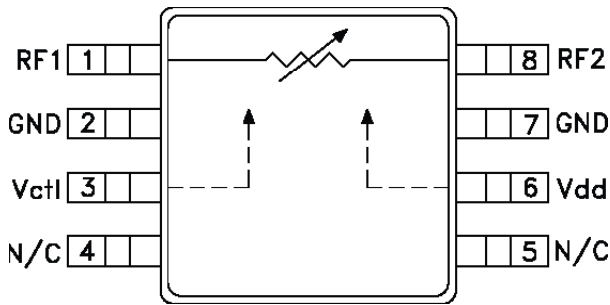

Features

- Single Positive Voltage Control: 0 to +3V
- High Attenuation Range: >50 dB @ 0.9 GHz
- High P1dB Compression Point: +16 dBm
- Ultra Small Package: MSOP

General Description

The HMC173MS8 is an absorptive voltage variable attenuator in an 8-lead MSOP package. The device operates with a positive supply voltage and a positive control voltage. Unique features include a high dynamic attenuation range and excellent power handling performance through all attenuation states. The HMC173MS8 is ideal for operation in wireless applications between 0.8 GHz and 1.6 GHz. 1.7 to 2.0 GHz operation is possible, with a reduced maximum attenuation of 30 dB and increased VSWR. The HMC173MS8 can be used with an external driver circuit for improved linearity of attenuation.

Electrical Specifications, $T_A = +25^\circ C, V_{dd} = +4.0 V_{dc}, 50 \text{ Ohm System}$

Parameter		Min.	Typ.	Max.	Units
Insertion Loss (Min. Atten.) (VCTL = 0.0 Vdc)	0.8 - 1.0 GHz		1.8	2.3	dB
	1.0 - 1.6 GHz		2.6	3.1	dB
	1.6 - 2.0 GHz		3.2	3.7	dB
Attenuation Range (VCTL = 0 to +3 V)	0.8 - 1.0 GHz	45	52		dB
	1.0 - 1.6 GHz	27	32		dB
	1.6 - 2.0 GHz	25	30		dB
Flatness (Peak to Peak)	0.8 - 1.0 GHz		±0.15		dB
	1.0 - 1.6 GHz		±0.25		dB
Return Loss (VCTL = 0 to +3 V)	0.8 - 1.0 GHz	6	12		dB
	1.0 - 1.6 GHz	5	8		dB
	1.6 - 2.0 GHz	5	7		dB
Input Power for 0.1 dB Compression (.825 GHz)	Min Attenuation		19		dBm
	Attenuation >2.0		9		dBm
Input Power for 1.0 dB Compression (.825 GHz)	Min Attenuation	21	25		dBm
	Attenuation >2.0	10	16		dBm
Input Third Order Intercept .825 GHz, Two-tone Input Power = +5.0 dBm Each Tone	Min Attenuation	30	37		dBm
	Attenuation >2.0	15	21		dBm
Switching Characteristics tRISE, tFALL (10/90% RF) tON, tOFF (50% CTL to 10/90% RF)	0.8 - 2.0 GHz		1.0		µS
			1.2		µS

GaAs MMIC VOLTAGE-VARIABLE ATTENUATOR, 0.8 - 2.0 GHz

Attenuation vs. Control Voltage @ 0.9 and 1.9 GHz

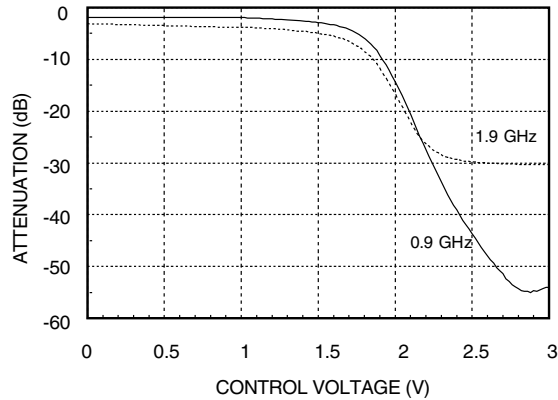

Input IP3 vs. Control Voltage @ .825 GHz

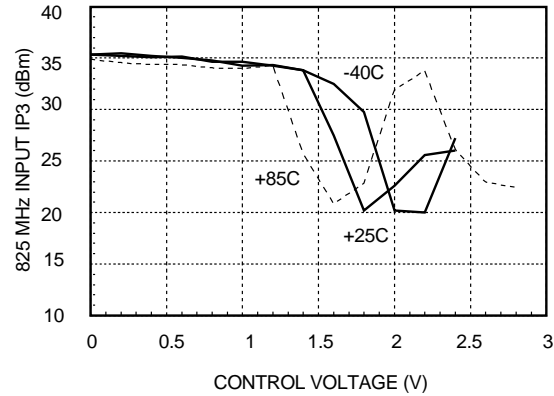

Attenuation vs. Temperature Normalized to +25°C @ .825 GHz

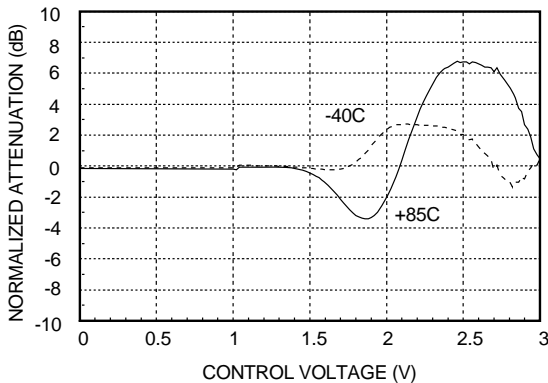

Input P1dB Compression @ .825 GHz

Input Power for 1 dB Compression Point						
Test Condition (.825 GHz)	VCTL (Vdc)	Vdd (Vdc)	+25C	+85C	-40C	Units
Min. Attenuation	0.0	+4.0	26	24	25	dBm
Max. Attenuation	+3.0	+4.0	16.5	15	23	dBm
Worst Case P1dB @ Typical VCTL	+1.8	+4.0	16.5	15.5	14	dBm

Broadband Attenuation and Insertion Loss

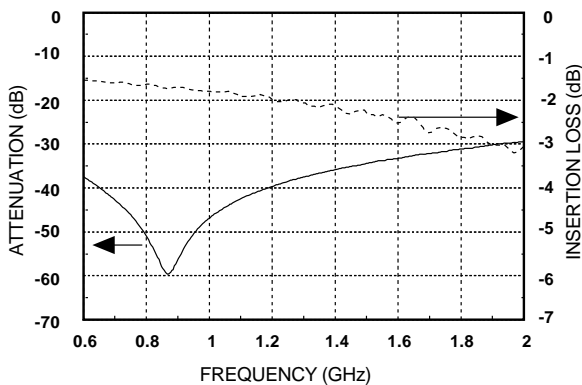

Broadband Return Loss vs. Control Voltage

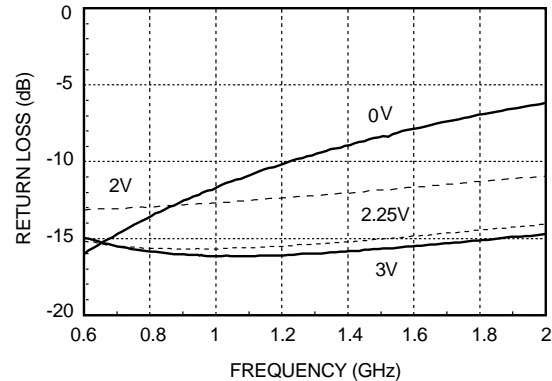

GaAs MMIC VOLTAGE-VARIABLE ATTENUATOR, 0.8 - 2.0 GHz

Typical Performance for 0.8 - 1.0 GHz Applications

**Attenuation vs.
Control Voltage @ .825 GHz**

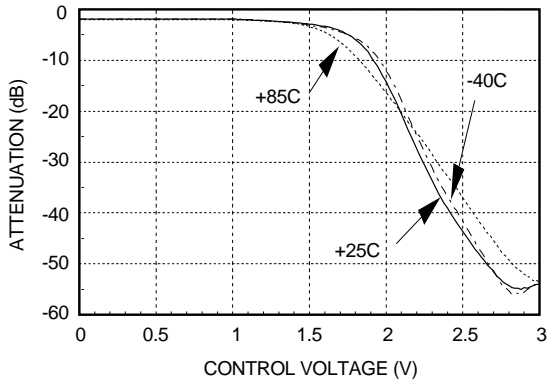

**Return Loss vs.
Control Voltage @ .825 GHz**

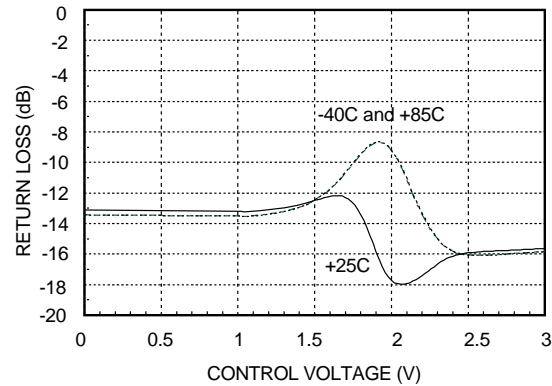

Typical Performance for 1.8 - 1.9 GHz Applications

**Attenuation vs.
Control Voltage @ 1.9 GHz**

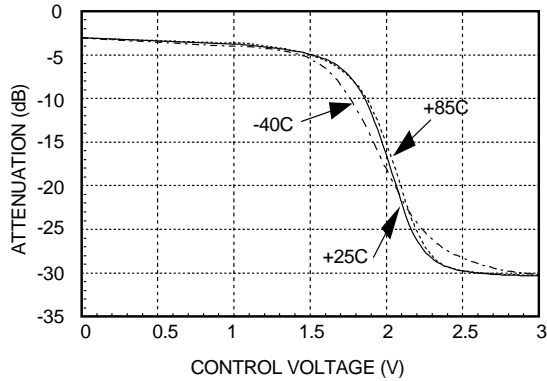

**Return Loss vs.
Control Voltage @ 1.9 GHz**

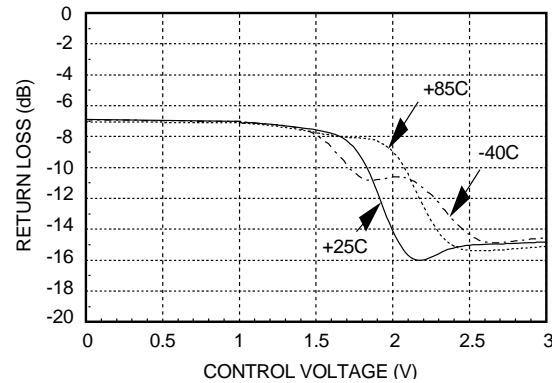

GaAs MMIC VOLTAGE-VARIABLE ATTENUATOR, 0.8 - 2.0 GHz

Absolute Maximum Ratings

V _{CTL}	-0.2 Vdc to Vdd	
Vdd	+8 Vdc	
Maximum Input Power Vdd = +4.0 Vdc	+29 dBm +21 dBm	Min. Attenuation Atten. >2 dB
Storage Temperature	-65 to +150 °C	
Operating Temperature	-40 to +85 °C	

Control and Bias Voltage

V _{CTL}	0 to +3 Vdc @ -100 μA to +100 μA
Vdd	+4.0 Vdc +/- 0.1 Vdc @ +100 μA

*Note: DC blocking capacitors are required for each RF port. Capacitor value determines lowest frequency of operation.

Outline Drawing

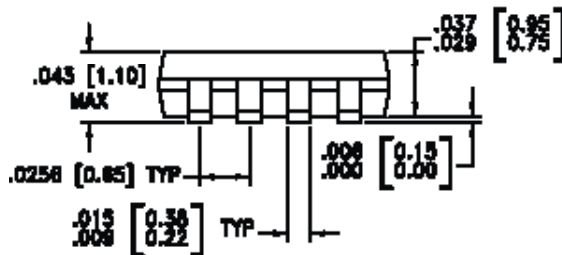
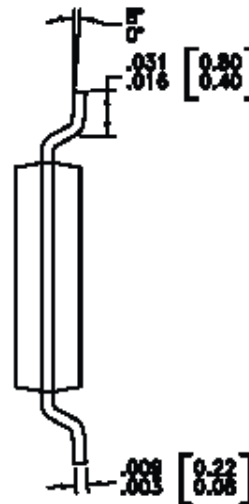
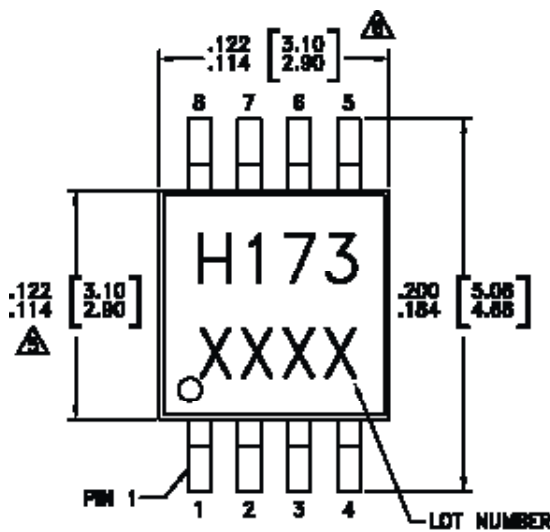

† STRESS INJECTION MOLDED
 ‡ PREGNATED.
 § R ALLOY
 ¶ LDER
 †† MILLIMETERS].
 ‡‡ MOLDFLASH OF 0.15mm PER SIDE.
 §§ MOLDFLASH OF 0.25mm PER SIDE.
 §§§ SOLDERED TO PCB RF GROUND.

GaAs MMIC VOLTAGE-VARIABLE ATTENUATOR, 0.8 - 2.0 GHz

Attenuation Linearizing Control Circuit For The HMC173MS8 Voltage Variable Attenuator

A driver circuit to improve the attenuation linearity of the HMC173MS8 can be implemented with a simple op-amp configuration. A *breakpoint* linearization circuit will scale the voltage supplied to the control line of the HMC173MS8, so that a more linear attenuation vs. control voltage slope can be achieved. A -5V and +5V supply is required.

Diode and resistor values which define the op-amp gain, and breakpoint were selected to optimize a measured production lot of attenuators at .825 GHz. R7 may be varied to optimize the performance of any given attenuator. If the input voltage to the linearizing circuit will not drop below 1.0V, the R9 and D2 may be omitted, and this will greatly reduce the overall power consumption of the driver circuit.

The linearizing circuit has been optimized for .825 GHz attenuation applications. A similar approach may be used at other frequencies by adjusting R1 - R9 resistor values.

Required Parts List

Part	Description	Manufacturer
AD822	Op-Amp	Analog Devices
R1	10K ohms	Panasonic
R2	200K ohms	Panasonic
R3	7.5K ohms	Panasonic
R4	39K ohms	Panasonic
R5	220K ohms	Panasonic
R6	91K ohms	Panasonic
R7	910 ohms	Panasonic
R8	51 ohms	Panasonic
R9	100 ohms	Panasonic
D1, D2	LL4148 D-35	Digi-Key

Application Circuit

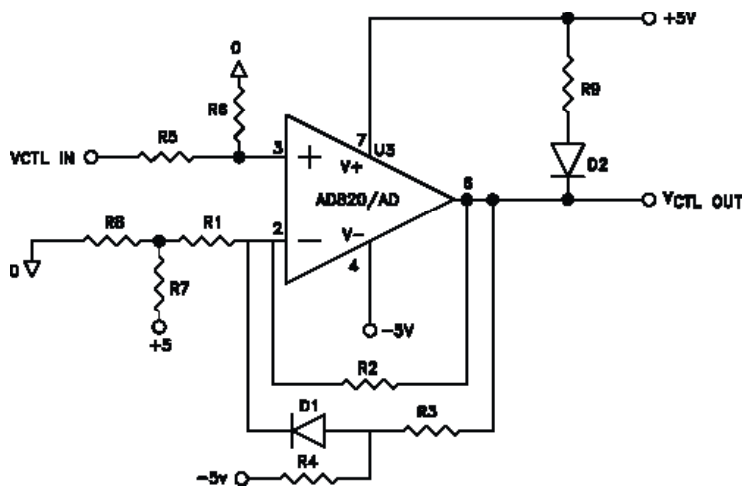

Return Loss vs. Control Voltage @ .825 GHz

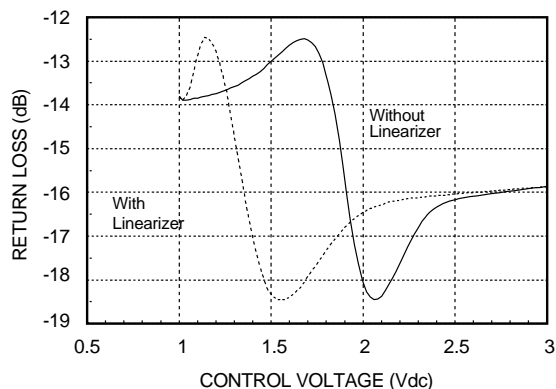

Attenuation vs. Control Voltage @ .825 GHz

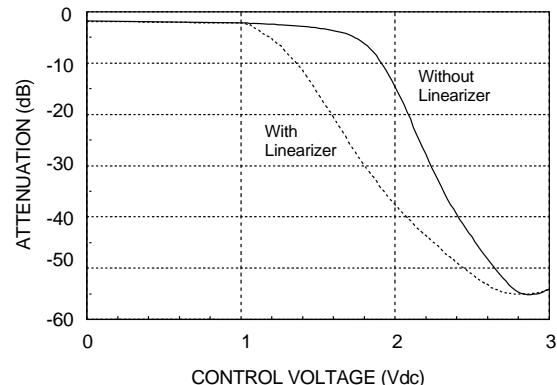

GaAs MMIC VOLTAGE-VARIABLE ATTENUATOR, 0.8 - 2.0 GHz

Evaluation Circuit Board

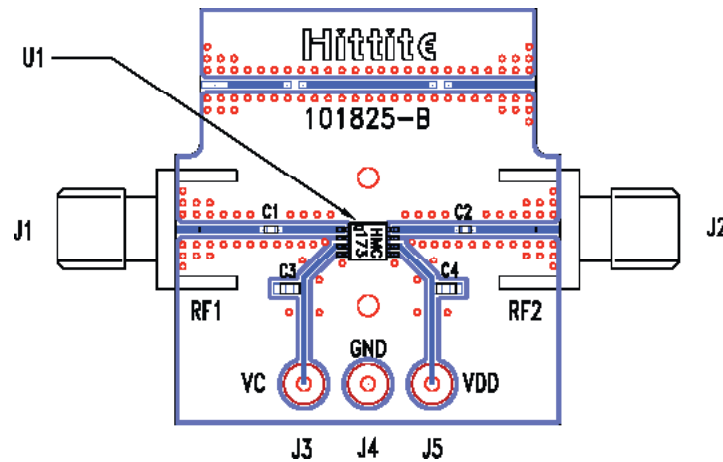

The circuit board used in the final application should use RF circuit design techniques. Signal lines should have 50 ohm impedance while the package ground leads should be connected directly to the ground plane similar to that shown. A sufficient number of VIA holes should be used to connect the top and bottom ground planes. The evaluation circuit board as shown is available from Hittite Microwave Corporation upon request.

Evaluation Circuit Board Layout Design Details

Layout Technique	Grounded Co-Planar Waveguide (GCPW)
Material	FR4
Dielectric Thickness	0.028" (0.71 mm)
50 Ohm Line Width	0.037" (0.94 mm)
Gap to Ground Edge	0.010" (0.25 mm)
Ground VIA Hole Diameter	0.014" (0.36 mm)
Connectors	SMA-F (EF - Johnson P/N 142-0701-806)