

GaAs MMIC VOLTAGE-VARIABLE ATTENUATOR, 1.5 - 2.3 GHz

Typical Applications

The HMC210MS8 / HMC210MS8E is ideal for:

- Base Station Infrastructure
- Portable Wireless
- MMDS

Features

- Single Positive Voltage Control: 0 to +2.5V
- High Attenuation Range: >50 dB @ 1.9 GHz
- High Input IP3: +15 dBm Typical (All Attenuation States)
- Ultra Small Package: MSOP

Functional Diagram

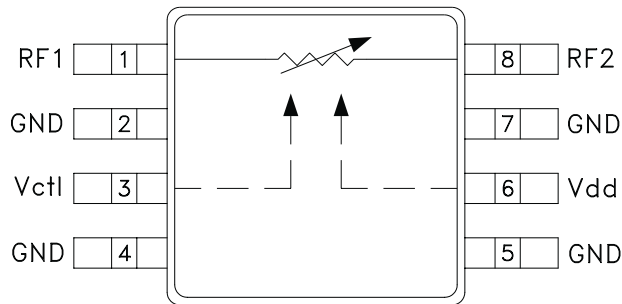

General Description

The HMC210MS8 & HMC210MS8E are miniature absorptive voltage variable attenuators in 8-lead MSOP packages. The device operates with a positive supply voltage (+2.5V), and a positive control voltage. A unique feature is the high third order intercept point for all attenuation states. Operation up to 2.3 GHz is possible with a reduced attenuation range of 31 dB.

Electrical Specifications, $T_A = +25^\circ\text{C}$, $V_{dd} = +2.5\text{ Vdc}$, 50 Ohm System

Parameter	Condition	Min.	Typical	Max.	Units
Insertion Loss (VCTL = 0 V Min. Atten.)	1.8 - 2.0 GHz		3.3	4.9	dB
	1.7 - 2.1 GHz		3.4	5.5	dB
	1.5 - 2.3 GHz		5.0	7.5	dB
Attenuation Range (VCTL = 0 to +2.5 V)	1.8 - 2.0 GHz	44	55		dB
	1.7 - 2.1 GHz	39	43		dB
	1.5 - 2.3 GHz	31	40		dB
Return Loss (VCTL = 0 to +2.5 V)	1.5 - 2.0 GHz		9		dB
	2.0 - 2.3 GHz		6		dB
Input Power for 0.1 dB Compression (f = 1.9 GHz)	Min Atten.		15		dBm
	Atten. >2.0		-5		dBm
Input Power for 1.0 dB Compression (f = 1.9 GHz)	Min Atten.	17	20		dBm
	Atten. >2.0	0	3		dBm
Input Third Order Intercept (f = 1.9 GHz, Two-tone Input Power = +5 dBm Each Tone)	Min Atten.	30	35		dBm
	Atten. >2.0	10	15		dBm
Switching Characteristics tRISE, tFALL (10/90% RF) tON, tOFF (50% CTL to 10/90% RF)	1.5 - 2.3 GHz		0.9		μS
			2.6		μS

For price, delivery, and to place orders, please contact Hittite Microwave Corporation:
20 Alpha Road, Chelmsford, MA 01824 Phone: 978-250-3343 Fax: 978-250-3373
Order On-line at www.hittite.com



GaAs MMIC VOLTAGE-VARIABLE ATTENUATOR, 1.5 - 2.3 GHz

Relative Attenuation vs. Control Voltage @ 1.9 and 2.2 GHz

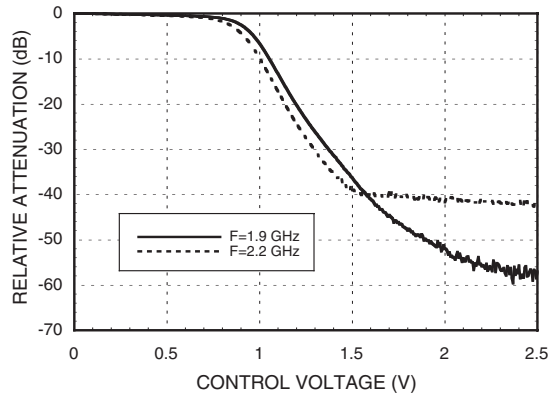

Input IP3 vs. Control Voltage @ 1.9 GHz

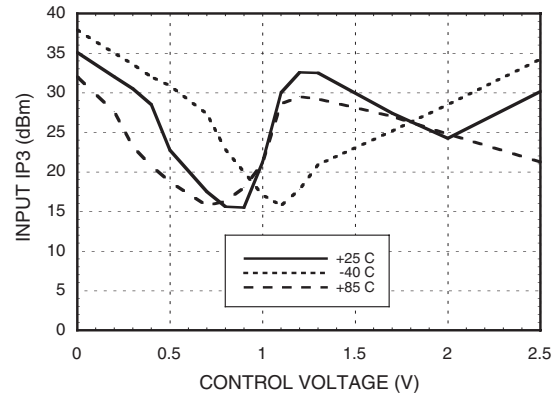

Attenuation vs. Temperature Normalized to +25° C @ 1.9 GHz

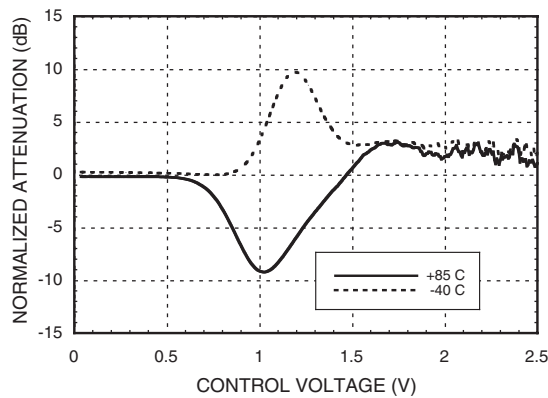

Typical Input P1dB Compression @ 1.9 GHz vs. Temperature

Input Power for 1 dB Compression Point						
Test Condition (1.9 GHz)	VCTL (Vdc)	Vdd (Vdc)	+25C	+85C	-40C	Units
Min. Attenuation	0.0	+2.5	20	20	21	dBm
Max. Attenuation	+2.5	+2.5	19	16	25	dBm
Worst Case P1dB	+1.0	+2.5	3	4	3	dBm

Broadband Insertion Loss

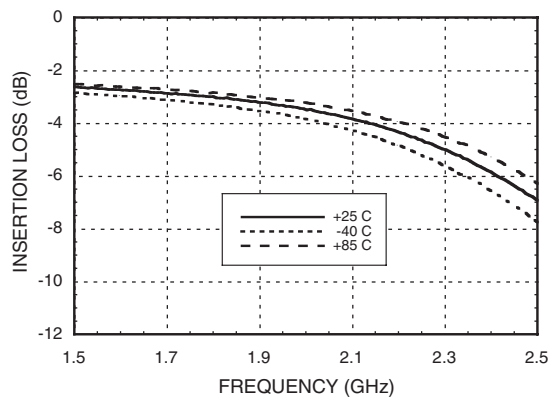

Broadband Maximum Relative Attenuation and Return Loss

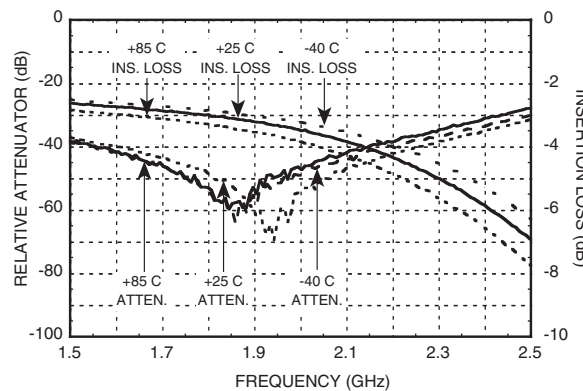



Typical Performance for 1.9 GHz Applications

**Attenuation vs.
Control Voltage @ 1.9 GHz**

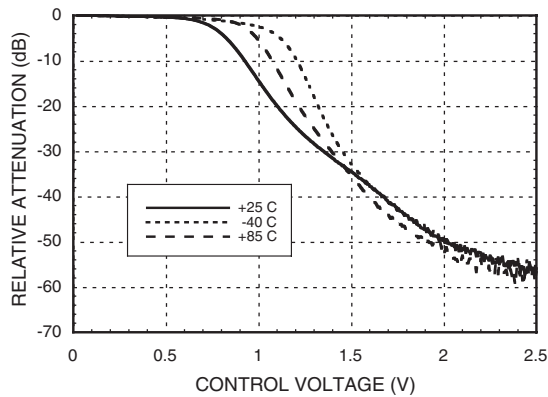

**Return Loss vs.
Control Voltage @ 1.9 GHz**

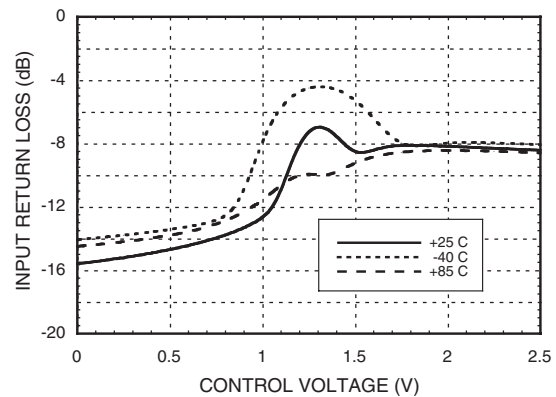

Typical Performance for 2.2 GHz Applications

**Attenuation vs.
Control Voltage @ 2.2 GHz**

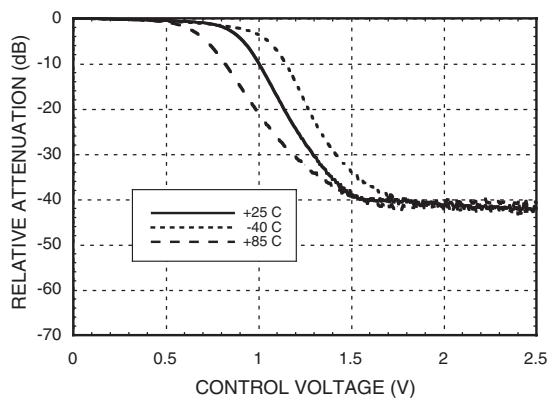

**Return Loss vs.
Control Voltage @ 2.2 GHz**

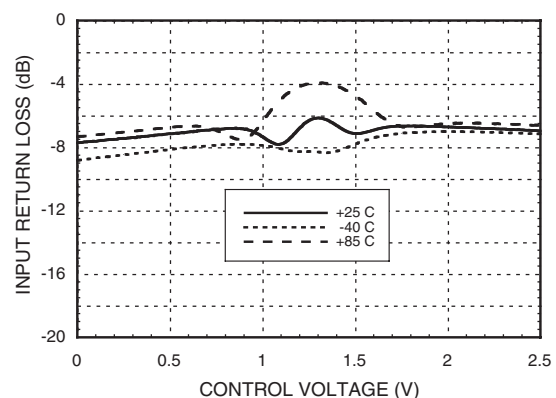

Absolute Maximum Ratings

VCTL	-0.2 Vdc to Vdd
Vdd	+8 Vdc
Maximum Input Power (Vdd = +2.5 Vdc)	+26 dBm @ Min. Attenuation, VCTL = +0.0V +20 dBm @ Atten. >2 dB
Storage Temperature	-65 to +150 °C
Operating Temperature	-40 to +85 °C

Control and Bias Voltage

VCTL	0 to +2.5 Vdc @ -100 µA to +100 µA
Vdd	+2.5 Vdc +/- 0.1 Vdc @ +100 µA

*Note: DC blocking capacitors are required for RF ports.
100 pF RF chip capacitors (0603 size) are recommended on RF1 & RF2 ports..



ELECTROSTATIC SENSITIVE DEVICE
OBSERVE HANDLING PRECAUTIONS

Outline Drawing

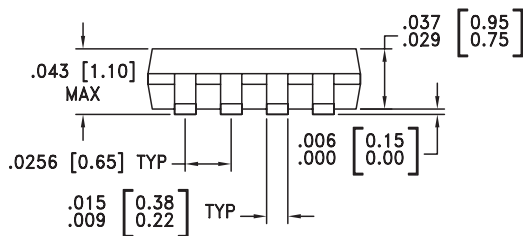
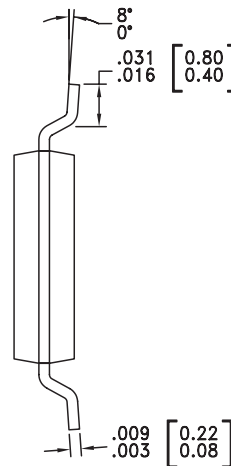
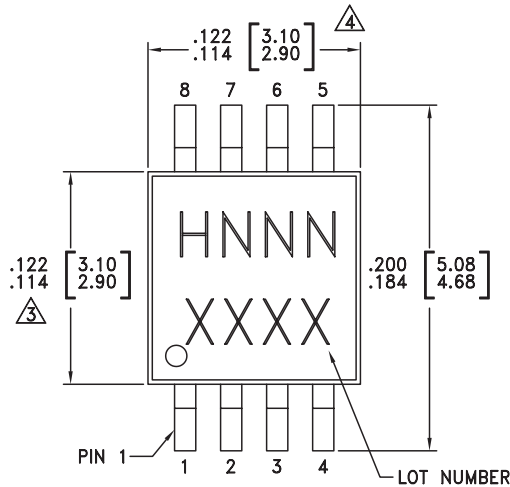

NOTES:

1. LEADFRAME MATERIAL: COPPER ALLOY
2. DIMENSIONS ARE IN INCHES [MILLIMETERS]
- △ DIMENSION DOES NOT INCLUDE MOLDFLASH OF 0.15mm PER SIDE.
- △ DIMENSION DOES NOT INCLUDE MOLDFLASH OF 0.25mm PER SIDE.
5. ALL GROUND LEADS MUST BE SOLDERED TO PCB RF GROUND.

Package Information

Part Number	Package Body Material	Lead Finish	MSL Rating	Package Marking ^[3]
HMC210MS8	Low Stress Injection Molded Plastic	Sn/Pb Solder	MSL1 ^[1]	H210 XXXX
HMC210MS8E	RoHS-compliant Low Stress Injection Molded Plastic	100% matte Sn	MSL1 ^[2]	H210 XXXX

[1] Max peak reflow temperature of 235 °C

[2] Max peak reflow temperature of 260 °C

[3] 4-Digit lot number XXXX

Evaluation Circuit Board

6

ATTENUATORS - SMT

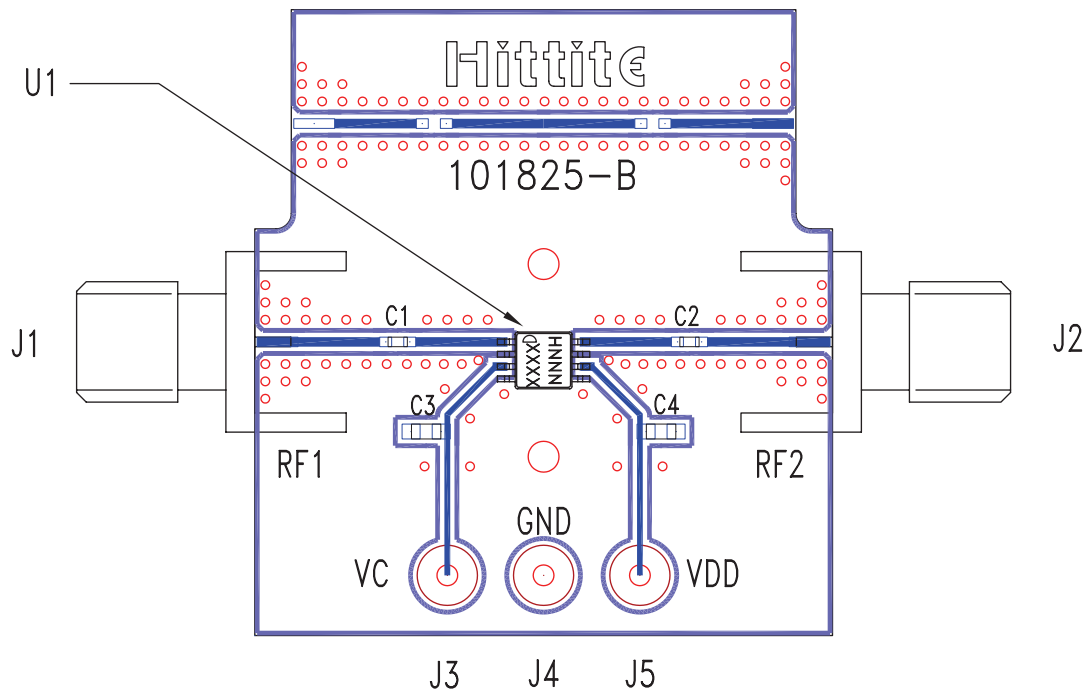

List of Materials for Evaluation PCB 101827 [1]

Item	Description
J1, J2	PCB Mount SMA RF Connector
J3 - J5	DC PIN
C1, C2	330 pF capacitor, 0402 package
C3, C4	10,000 pF capacitor, 0603 package
U1	HMC210MS8 / HMC210MS8E VVA
PCB [2]	101825 Eval Board

[1] Reference this number when ordering complete evaluation PCB

[2] Circuit Board Material: Rogers 4350

The circuit board used in the final application should be generated with proper RF circuit design techniques. Signal lines at the RF ports should be 50 ohm impedance and the package ground leads and package bottom should be connected directly to the PCB RF ground plane, similar to that shown above. The evaluation circuit board shown above is available from Hittite Microwave Corporation upon request.



MICROWAVE CORPORATION v02.0705



HMC210MS8 / 210MS8E

**GaAs MMIC VOLTAGE-VARIABLE
ATTENUATOR, 1.5 - 2.3 GHz**

Notes: