

1 dB LSB GaAs MMIC 5-BIT DIGITAL ATTENUATOR, DC - 4 GHz

Typical Applications

The HMC235QS16G is ideal for:

- Cellular
- PCS, WLL, LMDS
- IF applications.

Features

- Wide Bandwidth: DC - 4 GHz
- Attenuation Bits: 1, 2, 4, 8, 16 dB
- Miniature QSOP - 16 Package

Functional Diagram

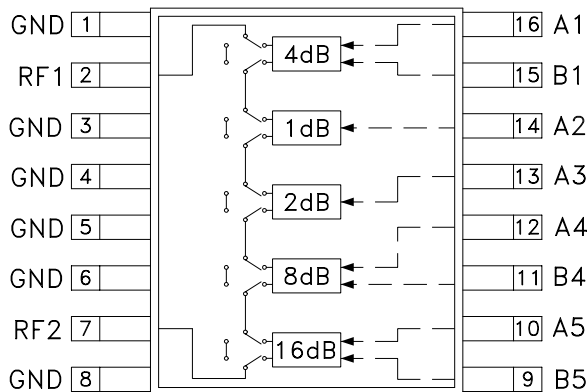

General Description

The HMC235QS16G is a broadband 5-bit digital attenuator in a 16 - lead (narrow pitch) surface mount QSOP plastic package with an exposed ground slug. This package occupies the same area as an 8 lead SOIC package. The 1, 2, 4 and 8 dB bits have less than 10 degrees relative phase shift. The five primary attenuation states can be activated independently, or collectively for attenuation levels of 1 to 31 dB.

Electrical Specifications, $T_A = +25^\circ C$, With 0-5V Control

| Parameter | Frequency | Min. | Typical | Max. | Units |
|--|----------------------------------|------|---------|------|-------|
| Insertion Loss | DC - 2 GHz | | 5.0 | 5.4 | dB |
| | 2 - 4 GHz | | 5.3 | 6.0 | dB |
| Attenuation Range | DC - 4 GHz | 25 | 31 | | dB |
| Input Return Loss (All States) | DC - 2 GHz | 7 | 12 | | dB |
| | 2 - 4 GHz | 4 | 7 | | dB |
| Output Return Loss (All States) | DC - 2 GHz | 10 | 18 | | dB |
| | 2 - 4 GHz | 7 | 11 | | dB |
| Attenuation Accuracy: | 1 dB Bit | 0.5 | 1 | 1.5 | dB |
| | 2 dB Bit | 1.4 | 2 | 2.6 | dB |
| | 4 dB Bit | 3.2 | 4 | 4.8 | dB |
| | 8 dB Bit | 7.0 | 8 | 9.0 | dB |
| | 16 dB Bit | 14.0 | 16 | 17.9 | dB |
| | All Bits (31 dB) | 26.0 | 31 | 35.0 | dB |
| Attenuation Accuracy: | 1 dB Bit | 0.5 | 1 | 1.5 | dB |
| | 2 dB Bit | 1.3 | 2 | 2.7 | dB |
| | 4 dB Bit | 3.2 | 4 | 4.8 | dB |
| | 8 dB Bit | 7.0 | 8 | 9.0 | dB |
| | 16 dB Bit | 14.0 | 16 | 17.9 | dB |
| | All Bits (31 dB) | 25.0 | 31 | 35.0 | dB |
| Switching Characteristics | tRISE, tFALL (10/90% RF) | | 3 | | ns |
| | tON, tOFF (50% CTL to 10/90% RF) | | 6 | | ns |
| Input Power for 0.2 dB Compression | 0.05 GHz Min. Atten. State | 8 | 12 | | dBm |
| | 0.05 GHz All Atten. States | 7 | 11 | | dBm |
| | 0.5 - 4 GHz Min. Atten. State | 18 | 24 | | dBm |
| | 0.5 - 4 GHz All Atten. States | 7 | 12 | | dBm |
| Input Third Order Intercept Point Two-tone Input Power = +5 dBm Each Tone | 0.05 GHz Min. Atten. State | 24 | 28 | | dBm |
| | 0.05 GHz All Atten. States | 23 | 30 | | dBm |
| | 0.5 - 4 GHz Min. Atten. State | 38 | 44 | | dBm |
| | 0.5 - 4 GHz All Atten. States | 22 | 32 | | dBm |

1 dB LSB GaAs MMIC 5-BIT DIGITAL ATTENUATOR, DC - 4 GHz

Insertion Loss

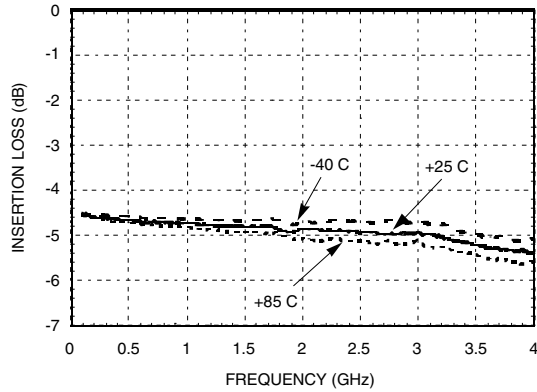

Relative Attenuation

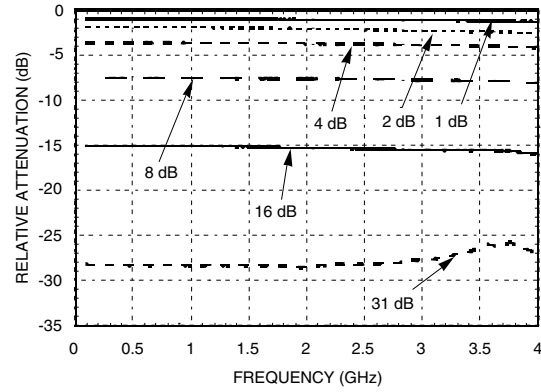

Return Loss (Reference State)

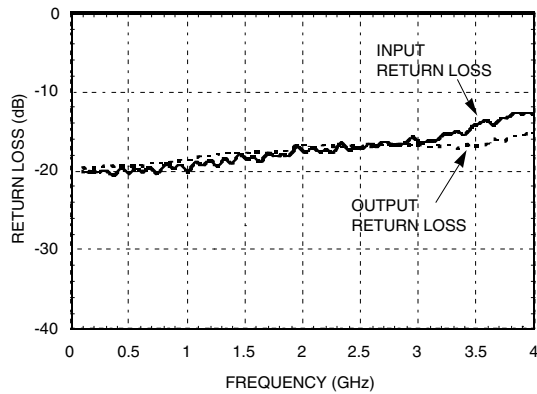

Relative Phase

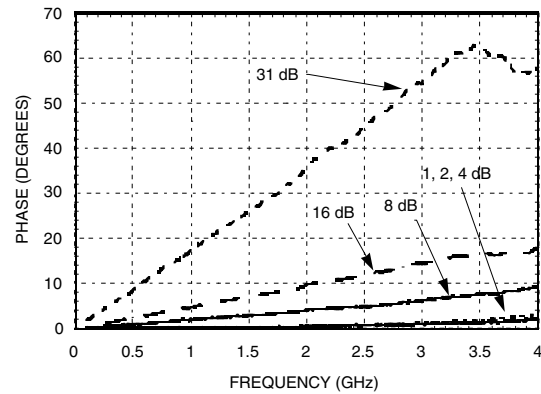

Input Return Loss

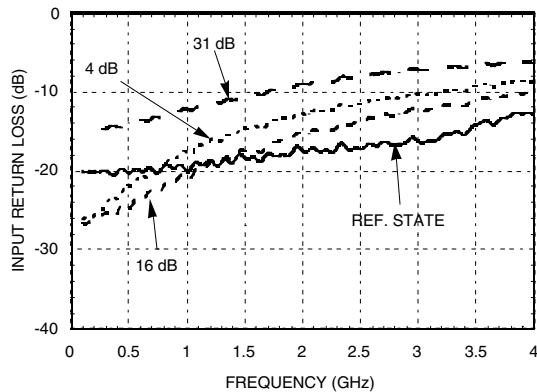

Output Return Loss

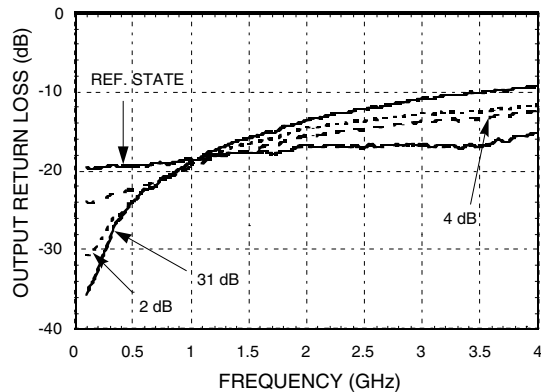

1 dB LSB GaAs MMIC 5-BIT DIGITAL ATTENUATOR, DC - 4 GHz

Input Power for 0.2 dB Compression
(Minimum Attenuation)

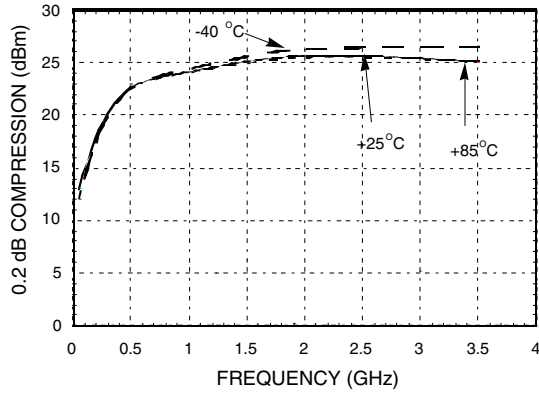

Input Power for 0.2 dB Compression
(Maximum Attenuation)

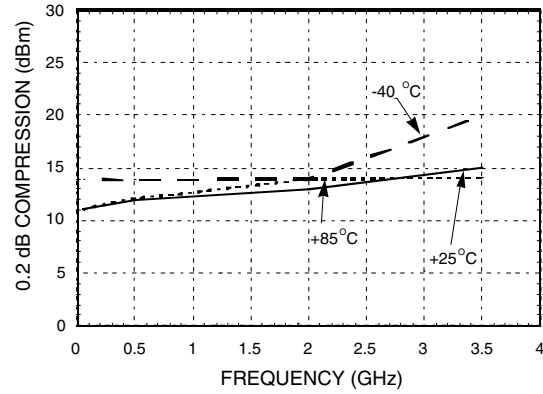

IP3 (Minimum Attenuation)

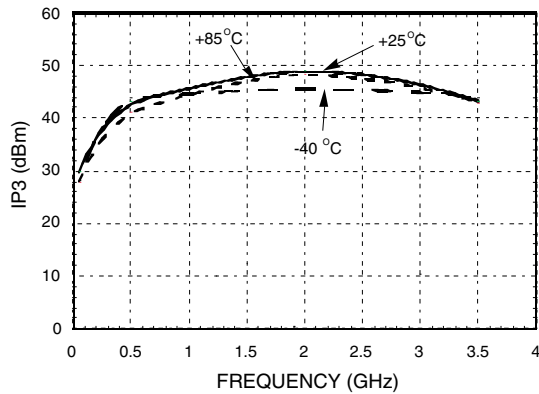

IP3 (Maximum Attenuation)

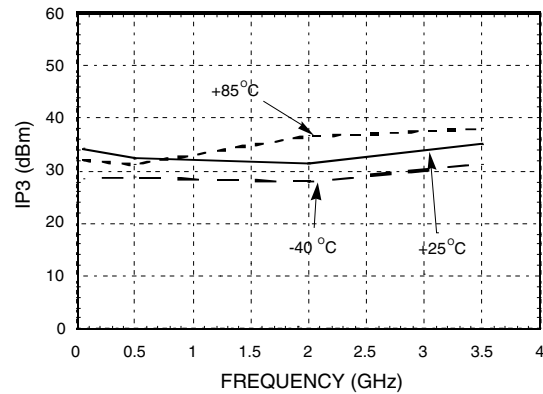

1 dB LSB GaAs MMIC 5-BIT DIGITAL ATTENUATOR, DC - 4 GHz

Control Voltages

| State | Bias Condition |
|-------|-------------------------------------|
| Low | 0 to -0.2 V @ 20 uA Max |
| High | -3V @ 50 uA Typ to -8V @ 500 uA Max |

Truth Table

| Control Input | | | | | | | | Att Set |
|---------------|------|------|------|----------|------|-----------|------|---------|
| 4 dB Bit | | 1 dB | 2 dB | 8 dB Bit | | 16 dB Bit | | |
| A! | B1 | A2 | A3 | A4 | B4 | A5 | B5 | |
| High | Low | High | High | High | Low | High | Low | Ref |
| High | Low | Low | High | High | Low | High | Low | 1dB |
| High | Low | High | Low | High | Low | High | Low | 2dB |
| Low | High | High | High | High | Low | High | Low | 4dB |
| High | Low | High | High | Low | High | High | Low | 8dB |
| High | Low | High | High | High | Low | Low | High | 16dB |

Any combination of the above states will provide an attenuation approximately equal to the sum of the bits selected.

Absolute Maximum Ratings

| | |
|------------------------------|-------------------|
| Control Voltage Range | +0.5 to +8.5 Vdc |
| Storage Temperature | -65 to +150 deg C |
| Operating Temperature | -40 to +85 deg C |
| RF Input Power (0.5 - 4 GHz) | +27 dBm |
| Insertion Loss State | +13 dBm |
| Any Attenuation State | |

Outline Drawing

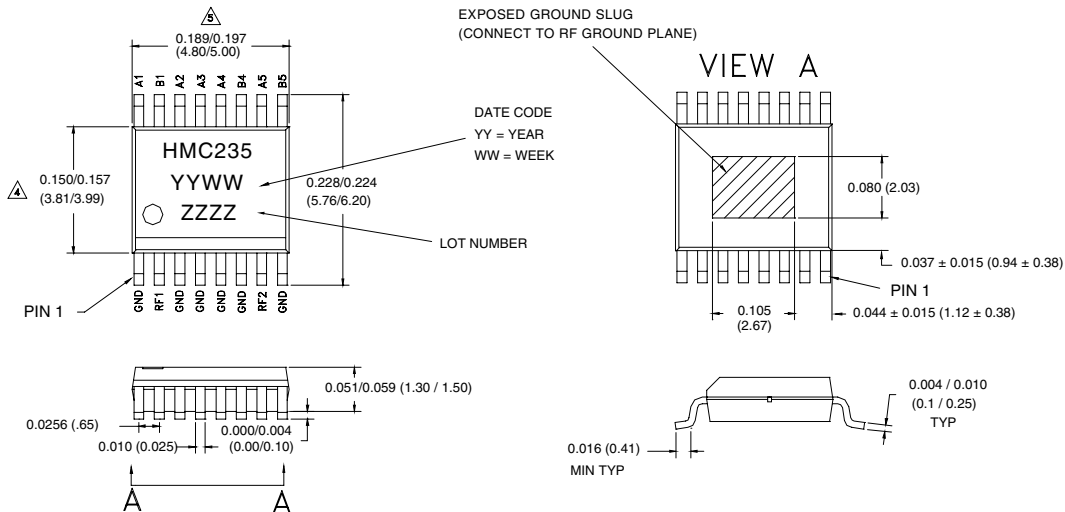

- MATERIAL:
 - PACKAGE BODY - LOW STRESS INJECTION - MOLDED PLASTIC.
 - LEADFRAME AND SLUG MATERIAL: COPPER ALLOY.
- PLATING: LEAD-TIN SOLDER PLATE.
- DIMENSIONS ARE IN INCHES (MILLIMETERS), UNLESS OTHERWISE SPECIFIED TOL. ARE ±0.005 (±0.13).
- DIMENSION DOES NOT INCLUDE MOLDFLASH OF 0.15mm PER SIDE.
- DIMENSION DOES NOT INCLUDE MOLDFLASH OF 0.25mm PER SIDE.

1 dB LSB GaAs MMIC 5-BIT DIGITAL ATTENUATOR, DC - 4 GHz

Suggested Driver Circuit

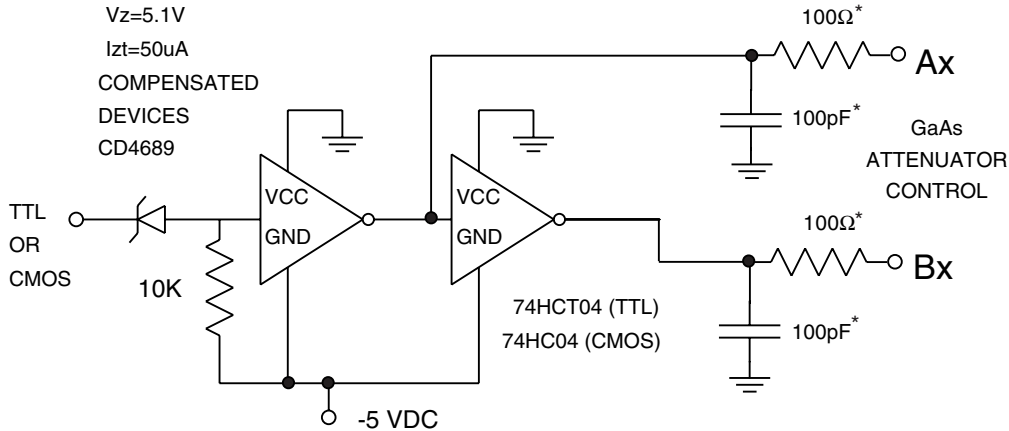

Simple driver using inexpensive standard logic ICs provides fast switching using minimum DC current.

*Recommended values to suppress unwanted RF signals at Ax/Bx control lines. Component values may be adjusted for switching speed considerations.

1 dB LSB GaAs MMIC 5-BIT DIGITAL ATTENUATOR, DC - 4 GHz

Evaluation Circuit Board

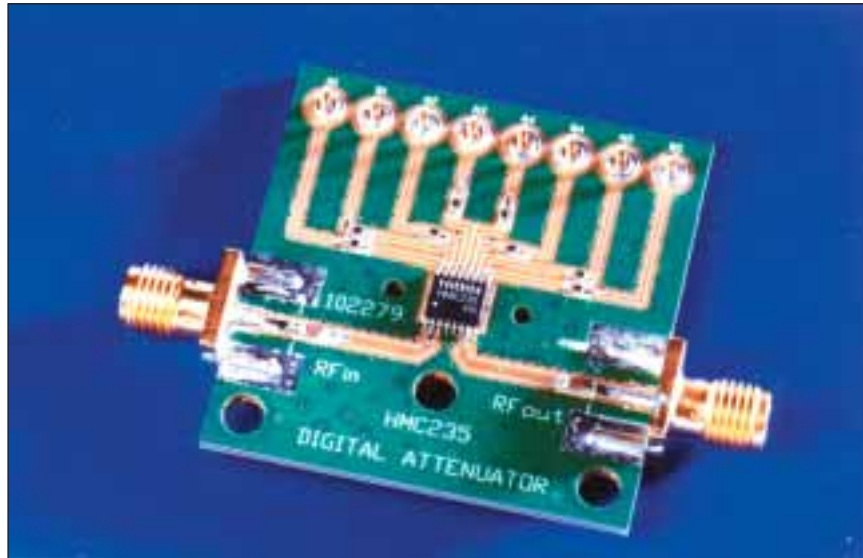

The circuit board used in the final application should use RF circuit design techniques. Signal lines should have 50 ohm impedance while the package ground leads should be connected directly to the ground plane similar to that shown. A sufficient number of VIA holes should be used to connect the top and bottom ground planes. The evaluation circuit board as shown is available from Hittite Microwave Corporation upon request.

Evaluation Circuit Board Layout Design Details

| | |
|--------------------------|---------------------------------------|
| Layout Technique | Ground Co-Planar Waveguide (GCPW) |
| Material | Rogers 4350 |
| Dielectric Thickness | 0.020" (0.51 mm) |
| 50 Ohm Line Width | 0.034" (0.86 mm) |
| Gap to Ground Edge | 0.010" (0.25 mm) |
| Ground VIA Hole Diameter | 0.014" (0.36 mm) |
| Connectors | SMA-F (EF - Johnson P/N 142-0701-806) |