



Typical Applications

The HMC280MS8G / HMC280MS8GE is ideal for:

- UNII & HiperLAN
- ISM

Features

- Psat Output Power: +24 dBm
- Output IP3: +38 dBm
- High Gain: 18 dB
- Single Supply: +3.6V
- Ultra Small Package: MSOP8G

Functional Diagram

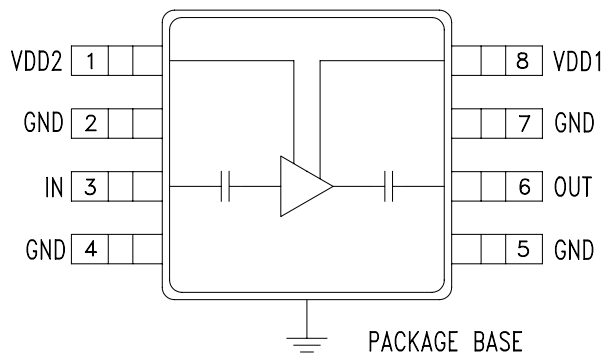

General Description

The HMC280MS8G & HMC280MS8GE are +3.6V GaAs MMIC power amplifiers covering 5 to 6 GHz. The device is packaged in a low cost, surface mount 8 lead MSOP plastic package with an exposed base paddle for improved RF ground and thermal dissipation. The amplifier provides 18 dB of gain and 24 dBm Psat while operating from a single positive supply. External component requirements are minimal with the amplifier occupying less than 0.023 sq. in. (14.6 sq. mm). All data is taken with the amplifier assembled into a 50 ohm test fixture with the exposed base paddle connected to RF ground.

Electrical Specifications, $T_A = +25^\circ C$, $V_{dd} = +3.6V$

Parameter	Min.	Typ.	Max.	Units
Frequency Range	5.0 - 6.0			GHz
Gain	14	19	23	dB
Gain Flatness		±1.0		dB
Input Return Loss	8	12		dB
Reverse Isolation	40	44		dB
Output Power for 1 dB Compression (P1dB)	5.0 - 5.5 Ghz 5.0 - 6.0 Ghz	20 18	23 22	dBm
Saturated Output Power (Psat)		21	24	dBm
Output Third Order Intercept (IP3)		33	38	dBm
Noise Figure			13	dB
Supply Current (Idd)(Vdd1 = Vdd2 = +3.6 Vdc)			480	mA



Broadband Gain & Return Loss

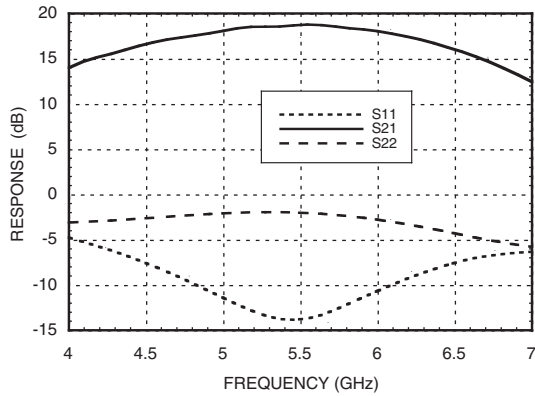

Gain vs. Temperature @ 3.6V

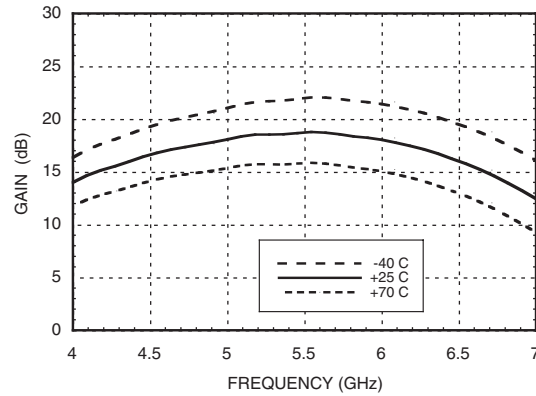

Psat vs. Supply Voltage

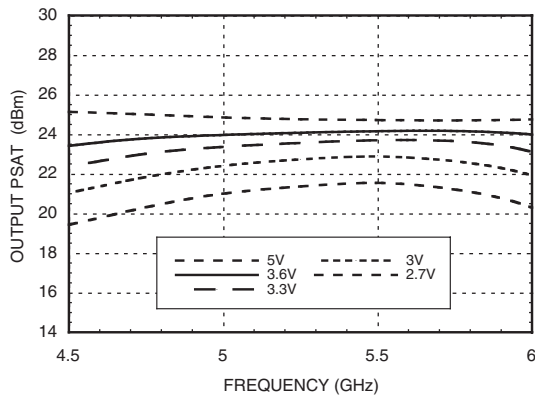

Psat vs. Temperature @ 3.6V

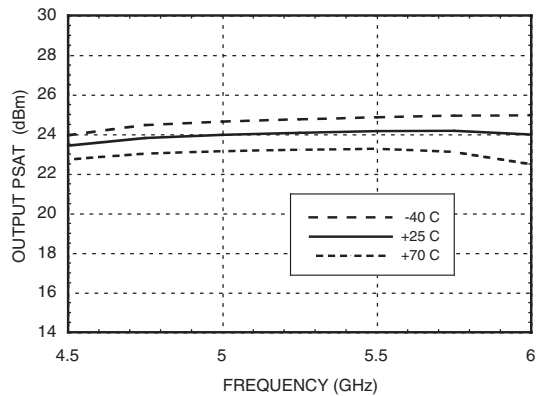

P1dB vs. Supply Voltage

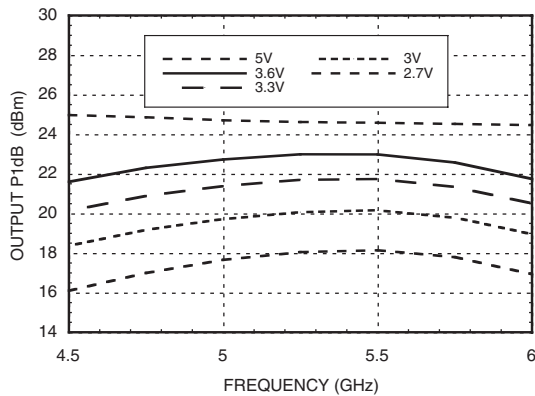

P1dB vs. Temperature @ 3.6V

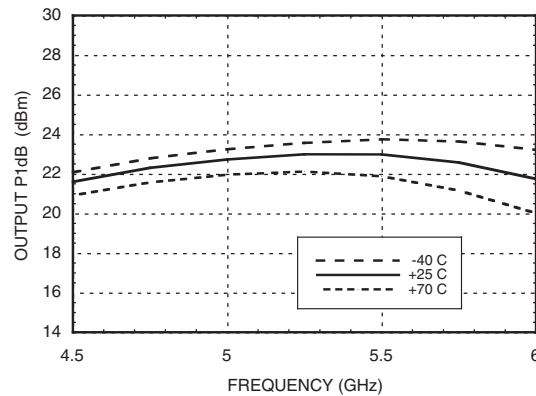



Power Compression @ 5.25 GHz

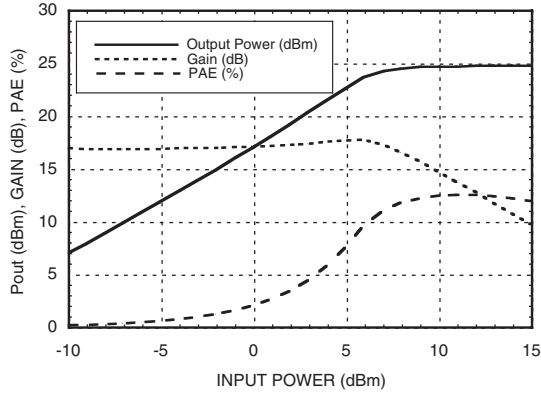

Output IP3 vs Supply Voltage @ 6.0 GHz

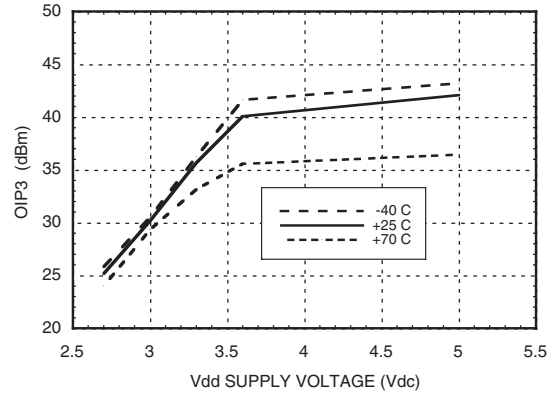

Output IP3 vs. Temperature @ 3.6V

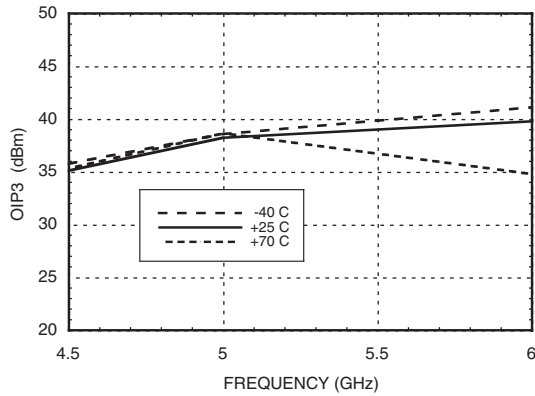

Output IP3 vs. Temperature @ 5.0V

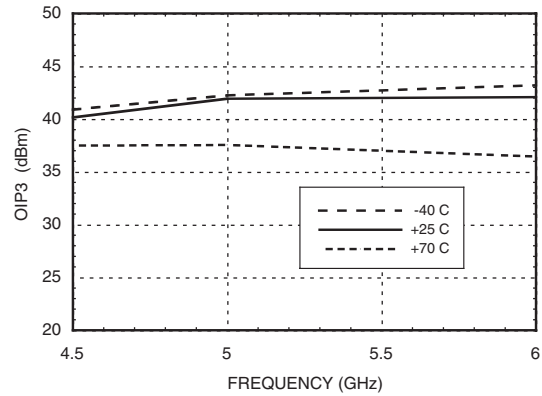

Reverse Isolation @ 3.6V

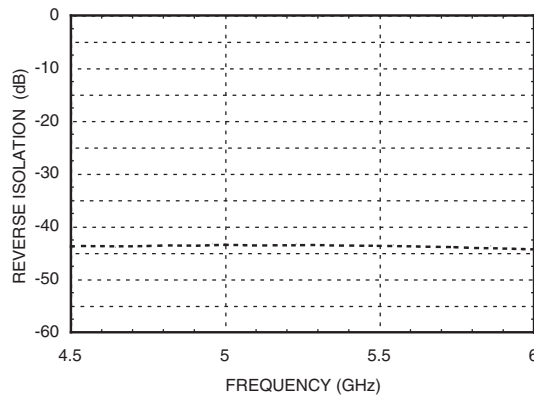

Absolute Maximum Ratings

Drain Bias Voltage (Vdd1, Vdd2)	+8.0 Vdc
RF Input Power (RFIn) (Vdd = +3.6 Vdc)	+14 dBm
Channel Temperature	150 °C
Continuous P _{diss} (T = 85 °C) (derate 41 mW/°C above 85 °C)	2.67 W
Thermal Resistance (channel to ground paddle)	24.3 °C/W
Storage Temperature	-65 to +150 °C
Operating Temperature	-55 to +85 °C



ELECTROSTATIC SENSITIVE DEVICE
OBSERVE HANDLING PRECAUTIONS

Outline Drawing

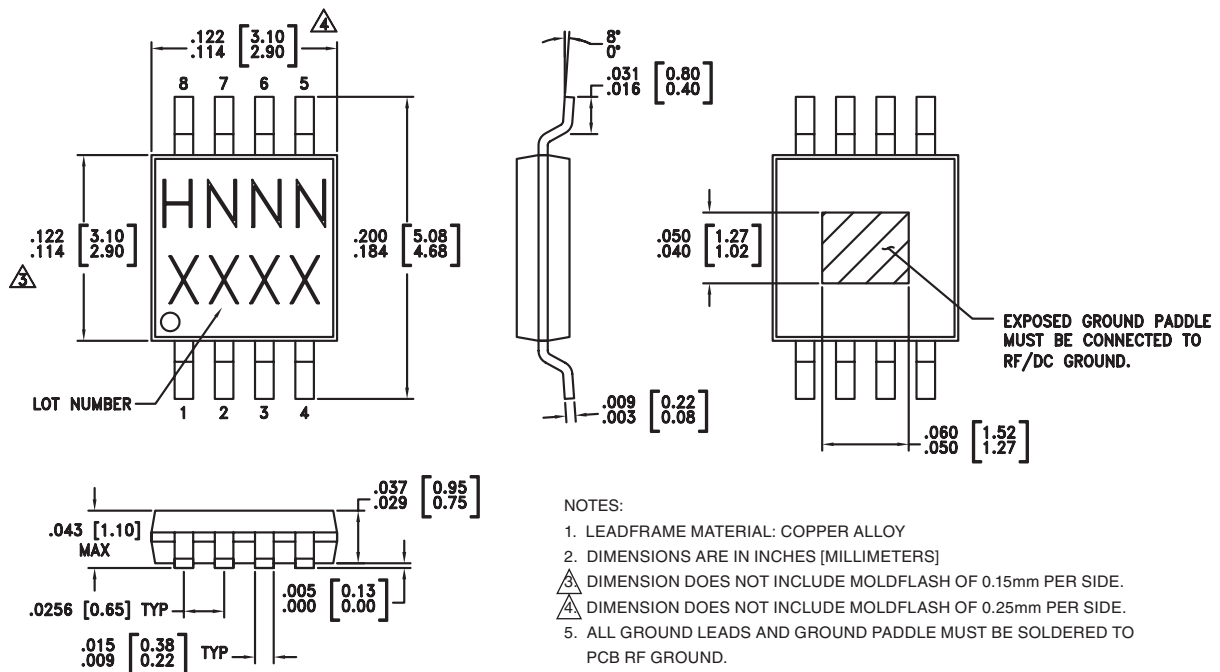

Package Information

Part Number	Package Body Material	Lead Finish	MSL Rating	Package Marking ^[3]
HMC280MS8G	Low Stress Injection Molded Plastic	Sn/Pb Solder	MSL1 ^[1]	H280 XXXX
HMC280MS8GE	RoHS-compliant Low Stress Injection Molded Plastic	100% matte Sn	MSL1 ^[2]	H280 XXXX

[1] Max peak reflow temperature of 235 °C

[2] Max peak reflow temperature of 260 °C

[3] 4-Digit lot number XXXX



Recommended PCB Layout

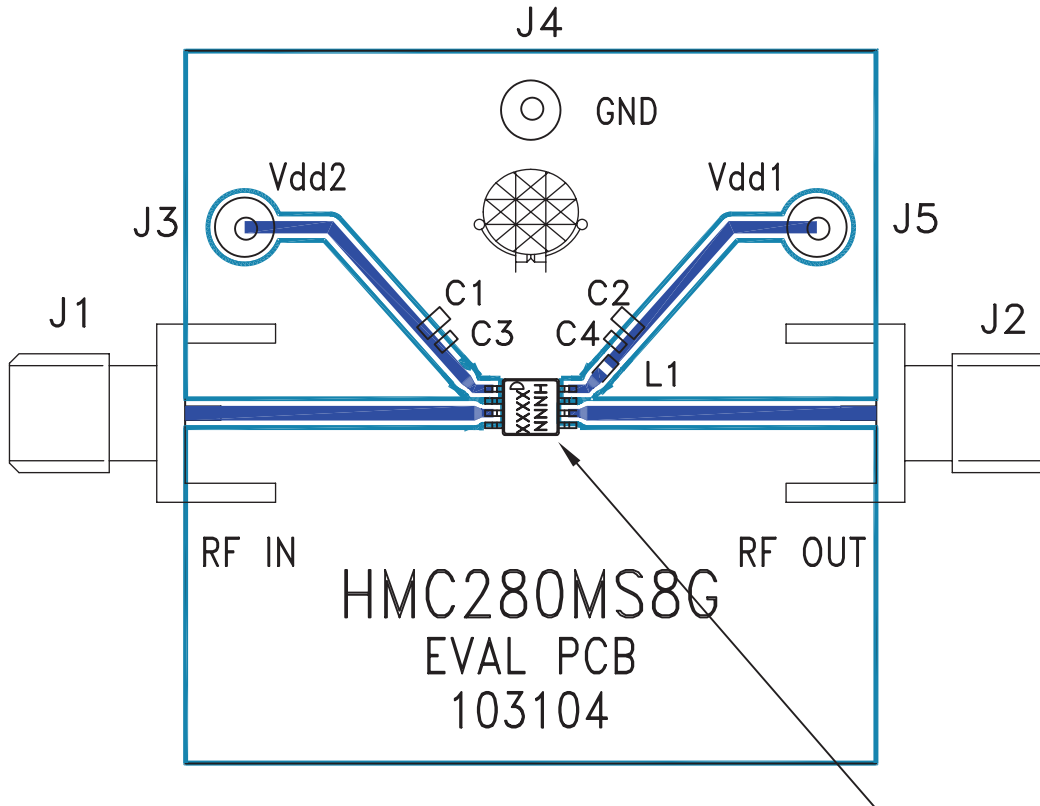

List of Materials for Evaluation PCB 103103 [1]

Item	Description
J1, J2	PCB Mount SMA Connector
J3, J4, J5	DC Pins
C1, C2	1000 pF Capacitor, 0603 Pkg.
C3, C4	100 pF Capacitor, 0402 Pkg.
L1	3.9 nH Inductor, 0402 Pkg.
U1	HMC280MS8G / HMC280MS8GE Amplifier
PCB [2]	103104 Evaluation Board

[1] Reference this number when ordering complete evaluation PCB

[2] Circuit Board Material: Roger 4350

The circuit board used in the final application should use RF circuit design techniques. Signal lines should have 50 ohm impedance while the package ground leads and exposed paddle should be connected directly to the ground plane similar to that shown. A sufficient number of via holes should be used to connect the top and bottom ground planes. The evaluation circuit board shown is available from Hittite upon request.



Application Circuit

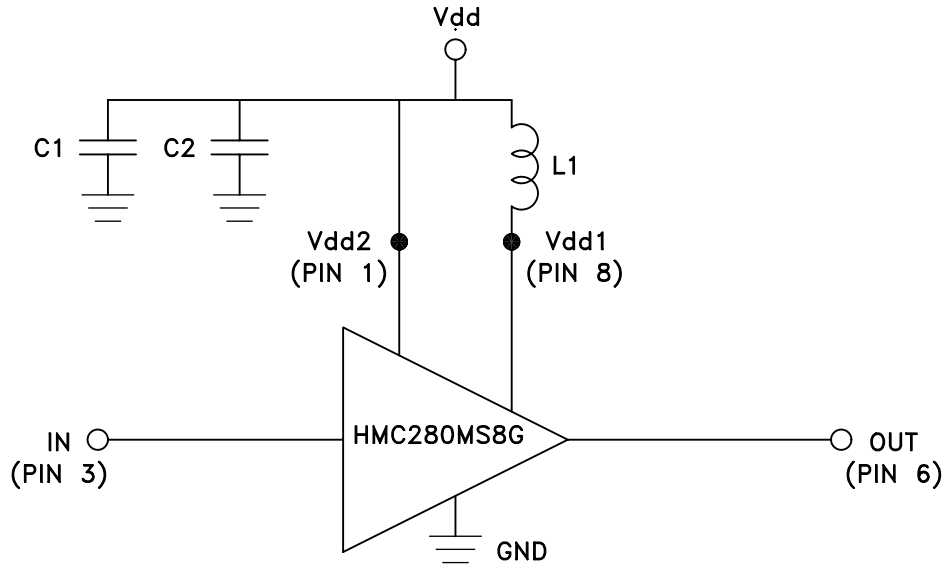

Note 1: Vdd1 and Vdd2 may be connected to a common Vdd feed after RF choke.

Recommended Component Values	
L1	3.9 nH
C1	1000 pF
C2	100 pF

Note 2: L1 should be located ≤ 0.020 " (0.508 mm) from pin 8 (Vdd1).