

2 dB LSB GaAs MMIC 3-BIT DIGITAL ATTENUATOR, 0.7 - 3.7 GHz

Typical Applications

The HMC288MS8 is ideal for:

- Cellular
- PCS, ISM, MMDS
- WLL applications

Functional Diagram

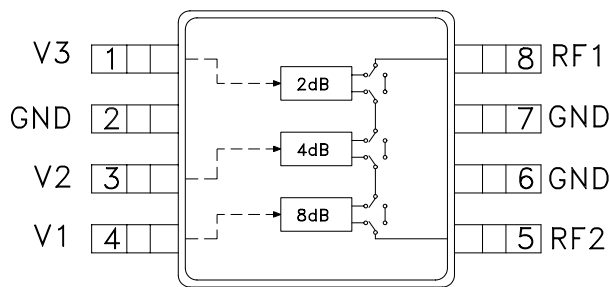

Features

- 2 dB LSB Steps to 14 dB
- Single Positive Control Per BIT
- Monotonic: ± 0.3 dB Bit Error Typical
- Miniature MSOP-8 Package, 14.8mm²

General Description

The HMC288MS8 is a broadband 3-bit positive control GaAs IC digital attenuator in an 8 lead MSOP surface mount plastic package. Covering 0.7 to 3.7 GHz, the insertion loss is typically less than 1.2 to 1.8 dB. The attenuator bit values are 2 (LSB), 4, and 8 dB for a total attenuation of 14 dB. Accuracy is excellent at ± 0.3 dB typical with an IIP3 of up to +51 dBm. Three bit control voltage inputs, toggled between 0 and +3 to +5V, are used to select each attenuation state at less than 50 uA each. A single Vdd bias of +3 to +5V applied through an external 5K Ohm resistor is required while occupying less than 14.8 mm².

Electrical Specifications,

$T_A = +25^\circ C$, $V_{dd} = +3V$ to $+5V$ & $V_{ctl} = 0/V_{dd}$ (Unless Otherwise Stated)

Parameter	Frequency	Min.	Typical	Max.	Units
Insertion Loss	0.7 - 1.4 GHz		1.0	1.4	dB
	1.4 - 2.3 GHz		1.3	1.7	dB
	2.3 - 2.7 GHz		1.5	2.0	dB
	2.7 - 3.7 GHz		1.7	2.3	dB
Attenuation Range	0.7 - 3.7 GHz		14		dB
Return Loss (RF1 & RF2, All Atten. States)	0.7 - 1.4 GHz	14	17		dB
	1.4 - 2.3 GHz	11	15		dB
	2.3 - 2.7 GHz	10	14		dB
	2.7 - 3.7 GHz	9	12		dB
Attenuation Accuracy: (Referenced to Insertion Loss)	0.7 - 1.4 GHz	$\pm 0.3 + 3\%$ of Atten. Setting Max			dB
	1.4 - 2.3 GHz	$\pm 0.2 + 3\%$ of Atten. Setting Max			dB
	2.3 - 2.7 GHz	$\pm 0.3 + 3\%$ of Atten. Setting Max			dB
	2.7 - 3.7 GHz	$\pm 0.3 + 4\%$ of Atten. Setting Max			dB
Input Power for 0.1 dB Compression	0.7 - 3.7 GHz	5V	25		dBm
		3V	22		dBm
Input Third Order Intercept Point (Two-tone Input Power = 0dBm Each Tone)	0.7 - 3.7 GHz	5V	51		dBm
		3V	47		dBm
Switching Characteristics	0.7 - 3.7 GHz				
		tRISE, tFALL (10/90% RF)	560		ns
		tON, tOFF (50% CTL to 10/90% RF)	600		ns

2 dB LSB GaAs MMIC 3-BIT DIGITAL ATTENUATOR, 0.7 - 3.7 GHz

Insertion Loss

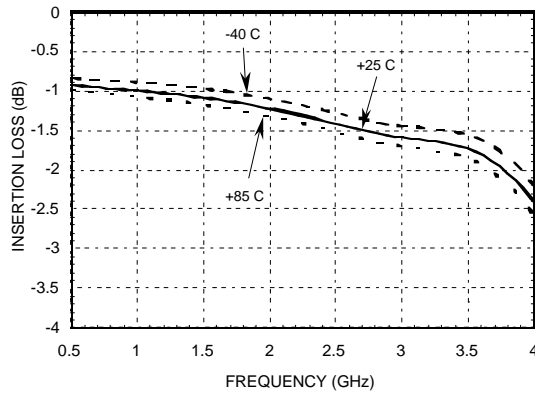

Return Loss RF1, RF2 (Only Major States are Shown)

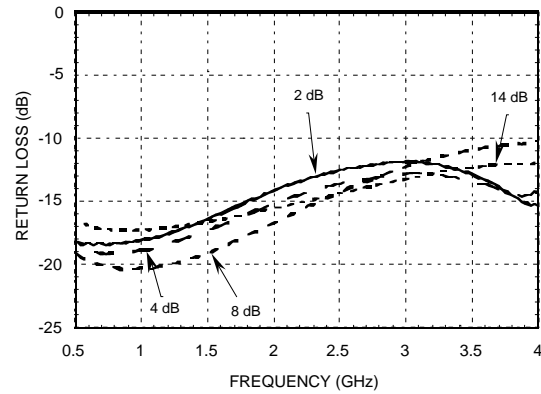

Normalized Attenuation (Only Major States are Shown)

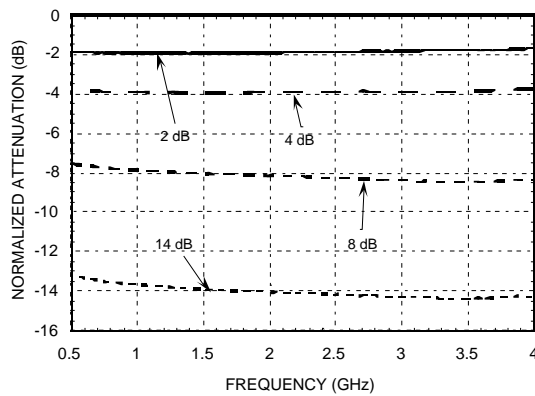

Absolute Bit Error vs. Attenuation State

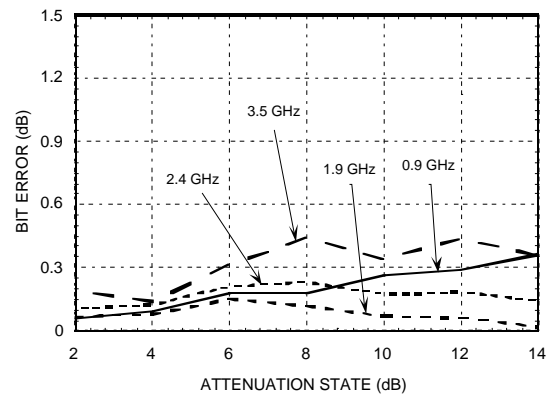

Absolute Bit Error vs. Frequency (Only Major States are Shown)

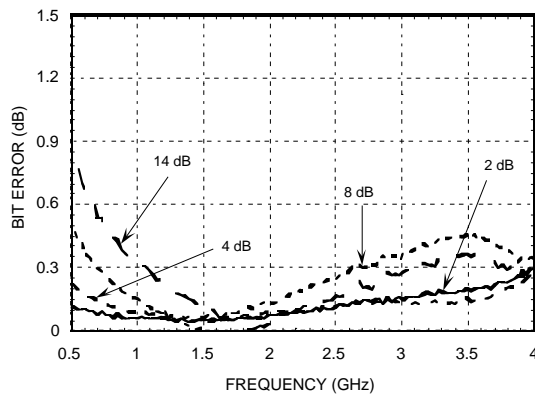

Relative Phase vs. Frequency (Only Major States are Shown)

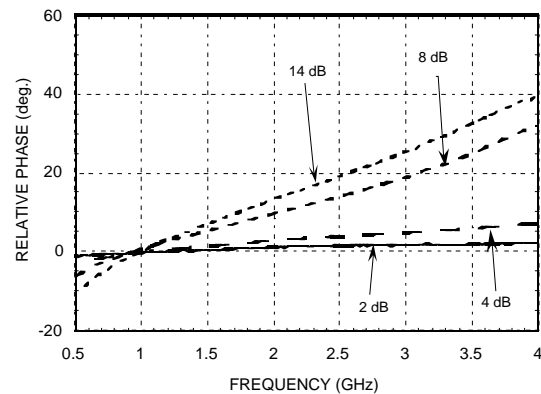

Note: All Data Typical Over Voltage (+3V to +5V) & Temperature (-40 to +85 deg. C.).

For price, delivery, and to place orders, please contact Hittite Microwave Corporation:
12 Elizabeth Drive, Chelmsford, MA 01824 Phone: 978-250-3343 Fax: 978-250-3373
Order Online at www.hittite.com

2 dB LSB GaAs MMIC 3-BIT DIGITAL ATTENUATOR, 0.7 - 3.7 GHz

Truth Table

Control Voltage Input			Attenuation Setting RF1 - RF2
V1 8 dB	V2 4 dB	V3 2 dB	
High	High	High	Reference I.L.
High	High	Low	2 dB
High	Low	High	4 dB
Low	High	High	8 dB
Low	Low	Low	14 dB Max. Atten.

Any combination of the above states will provide an attenuation approximately equal to the sum of the bits selected.

Control & Bias Voltages

State	Bias Condition
Low	0 to +0.2V @ 20 uA Max.
High	Vdd ± 0.2V @ 50 uA Max

Note: Vdd = +3V to 5V ± 0.2V

Application Circuit

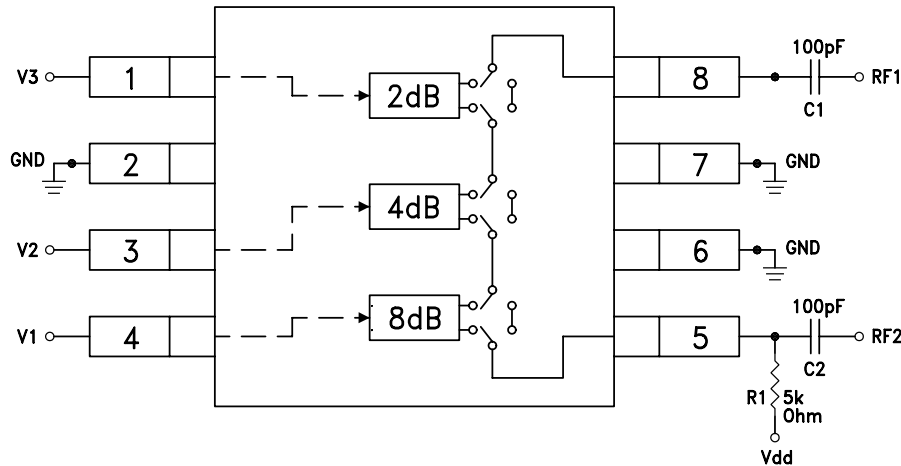

DC blocking capacitors C1 & C2 are required on RF1 & RF2. Choose C1 = C2 = 100 ~ 300 pF to allow lowest customer specific frequency to pass with minimal loss. R1 = 5K Ohm is required to supply voltage to the circuit through either PIN 5 or PIN 8.

2 dB LSB GaAs MMIC 3-BIT DIGITAL ATTENUATOR, 0.7 - 3.7 GHz

Absolute Maximum Ratings

Control Voltage (V1, V2, V3)	Vdd + 0.5 Vdc
Bias Voltage (Vdd)	+8.0 Vdc
Storage Temperature	-65 to +150 °C
Operating Temperature	-40 to +85 °C
RF Input Power (0.7 - 4 GHz)	+28 dBm

Outline Drawing

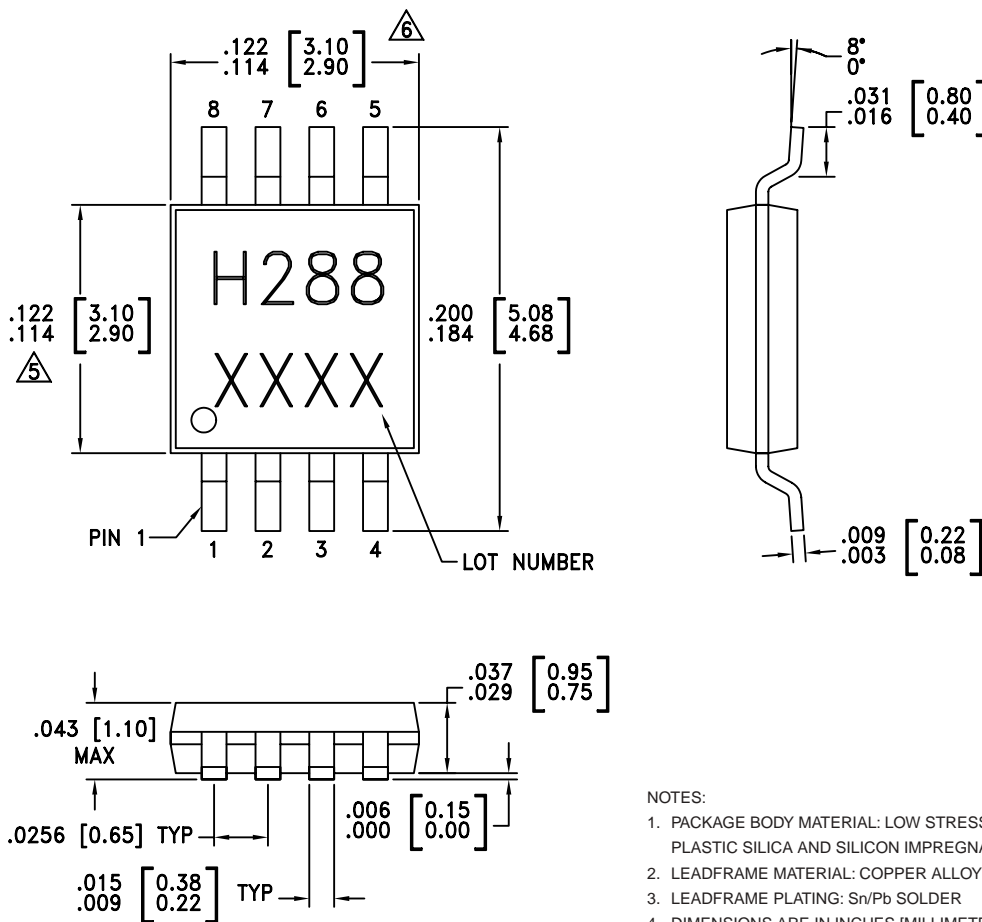

NOTES:

1. PACKAGE BODY MATERIAL: LOW STRESS INJECTION MOLDED PLASTIC SILICA AND SILICON IMPREGNATED.
2. LEADFRAME MATERIAL: COPPER ALLOY
3. LEADFRAME PLATING: Sn/Pb SOLDER
4. DIMENSIONS ARE IN INCHES [MILLIMETERS].
5. DIMENSION DOES NOT INCLUDE MOLDFLASH OF 0.15mm PER SIDE.
6. DIMENSION DOES NOT INCLUDE MOLDFLASH OF 0.25mm PER SIDE.
7. ALL GROUND LEADS MUST BE SOLDERED TO PCB RF GROUND.

2 dB LSB GaAs MMIC 3-BIT DIGITAL ATTENUATOR, 0.7 - 3.7 GHz

Evaluation Circuit Board

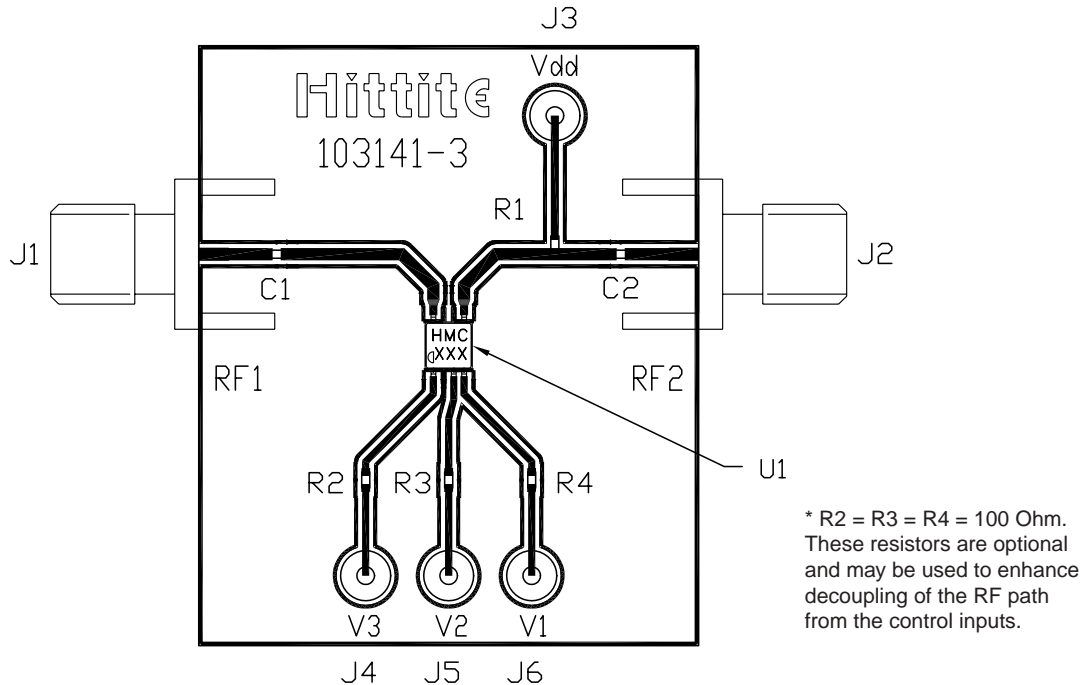

The circuit board used in the final application should use RF circuit design techniques. Signal lines should have 50 ohm impedance while the package ground leads should be connected directly to the ground plane similar to that shown. A sufficient number of VIA holes should be used to connect the top and bottom ground planes. The evaluation circuit board as shown is available from Hittite Microwave Corporation upon request.

List of Material

Item	Description
J1 - J2	PC Mount SMA Connector
J3 - J6	DC Pin
R1	5k Ohm Resistor, 0402 Chip
R2, R3, R4	100 Ohm Resistor, 0402 Chip
C1, C2	0402 Chip Capacitor, Select for Lowest Frequency of Operation
U1	HMC288MS8 Digital Attenuator
PCB*	103141 Evaluation PCB 1.5" x 1.5"
*Circuit Board Material: Rogers 4350	

2 dB LSB GaAs MMIC 3-BIT DIGITAL ATTENUATOR, 0.7 - 3.7 GHz

Notes: